

# TECNICO

—  
2022 | 23

AUSTRIA | MOLTO LUCE GMBH

HEADQUARTERS WELS  
Office & Showroom  
Europastraße 45  
4600 Wels  
T: +43 7242 698-0  
M: office@moltoluce.com

SWITZERLAND | MOLTO LUCE AG

LENZBURG  
Office  
Niederlenzerstraße 25  
5600 Lenzburg  
T: +41 62 885 70 30  
M: office.lenzburg@moltoluce.com

[www.moltoluce.com](http://www.moltoluce.com)

MOLTO LUCE®



V\_0018



MOLTO LUCE®

# TECNICO

—  
2022|23

## 24h SHOP

Unsere Produkte mit dem 24h Logo sind ab sofort auf Wunsch innerhalb von 24h versandbereit! Achtung: Unser 24h READY TO DELIVER Angebot gilt für den EU Raum!



Jetzt einfach im Webshop bestellen:



## LIEFER- UND VERKAUFSBEDINGUNGEN

Mit Erscheinen dieses Kataloges verlieren alle bisherigen Preise ihre Gültigkeit. Wir liefern ausschließlich nach unseren gültigen Liefer- und Verkaufsbedingungen. Die Ware bleibt bis zur vollständigen Bezahlung im Eigentum der Molto Luce GmbH. Es gelten unsere allgemeinen Geschäftsbedingungen, abrufbar auf [www.moltoluce.com](http://www.moltoluce.com).

## HAFTUNGSAUSSCHLUSS UND NUTZUNGSRECHT

Alle Daten in diesem Katalog haben rein informativen Wert. Die Molto Luce GmbH behält sich das Recht vor, die Daten ohne vorhergehende Bekanntgabe oder Begründung zu ändern. Alle Maße sind in Natur zu prüfen. Zudem sind manche, im Katalog abgebildeten Produkte Bildretuschen oder Renderings, die ausschließlich zur Veranschaulichung der Einsatzmöglichkeiten dienen. Für mögliche Irrtümer, Satz- oder Druckfehler sowie Farbabweichungen übernimmt die Molto Luce GmbH keinerlei Haftung. Inhalte und Bilder aus diesem Katalog dürfen ohne Zustimmung der Molto Luce GmbH weder, bearbeitet, vervielfältigt noch veröffentlicht werden.

## QR-CODE SCANNEN UND ALLE WICHTIGEN INFOS ZM PRODUKT ERHALTEN

Scannen sie den QR-Code der Produkte und erhalten sie sämtliche benötigte Informationen wie z.B. Preise, Lagerstand, Datenblatt, Montageanleitungen, LTD Dateien, ULD-Dateien, 3-DS Dateien und Ausschreibungstexte auf ihr Tablet oder Mobiltelefon.

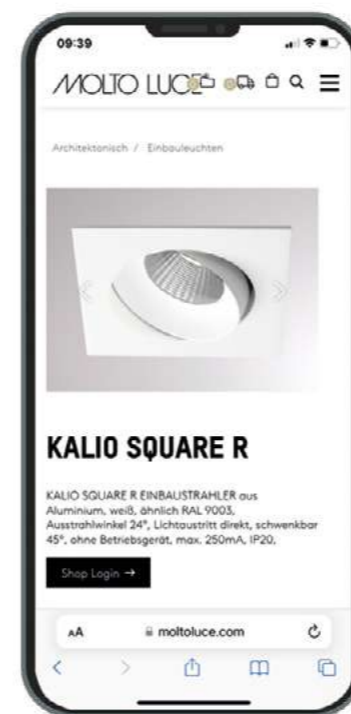

### KALIO SQUARE R

INFORMATION	LEISTUNG	mA	LUMEN	CRi>	KELVIN	L x B x ET	DA L x B	FARBE	REFL.	ART.NR.
Einbaustrahler, Aluminiumdruckguss, Feinstruktur matt pulverbeschichtet, schwenkbar 45°, zurückversetzte Lichtquelle, exkl. Konverter	LED 8W	250	860	90	2700	96 x 96 x 83	80 x 80	weiß	24°	308-30023500
	LED 8W	250	860	90	2700	96 x 96 x 83	80 x 80	schwarz	24°	308-30023600
	LED 8W	250	860	90	2700	96 x 96 x 83	80 x 80	weiß	38°	308-30033500
	LED 8W	250	860	90	2700	96 x 96 x 83	80 x 80	schwarz	38°	308-30033600
	LED 8W	250	900	90	3000	96 x 96 x 83	80 x 80	weiß	24°	308-30029500
	LED 8W	250	900	90	3000	96 x 96 x 83	80 x 80	schwarz	24°	308-30029600
	LED 8W	250	900	90	3000	96 x 96 x 83	80 x 80	weiß	38°	308-30039500
	LED 8W	250	900	90	3000	96 x 96 x 83	80 x 80	schwarz	38°	308-30039600

## MOLTO LUCE - EIN LEITBETRIEB

Molto Luce führt das Qualitätszeichen der Leitbetriebe Austria. Damit werden Unternehmen ausgezeichnet, die nicht auf kurzfristige Gewinne setzen, sondern auf nachhaltigen Unternehmenserfolg. Betriebe, die durch die Markt- und Werteorientierung zur Entwicklung der Region und Branche beitragen.

[www.leitbetriebe.at](http://www.leitbetriebe.at)













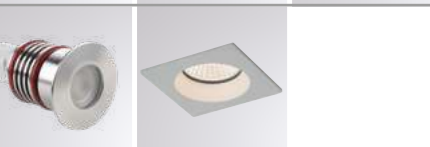

## MOLTO LUCE – TOP SUPPLIER RETAIL 2019

Molto Luce wurde als Lösungspartner des EHI Energiemanagement-Award-Preisträgers Metro Cash & Carry Österreich GmbH in der Kategorie „Pilotfilialen mit vorbildlicher Energieeffizienz/Nachhaltigkeit“ mit dem Topp Supplier Retail Award 2019 ausgezeichnet.

In den Augen der Jury haben wir mit einem besonders erfolgreichen Konzept zur Energieeinsparung und zum ressourcenschonenden Einsatz von Energie in der Filiale unseres Partners einen wesentlichen Beitrag geleistet.

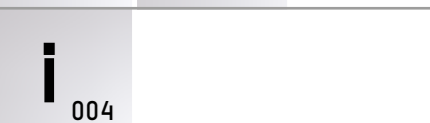

	DECKENEINBAU	STRAHLER S. 008-039   DOWNLIGHTS S. 040-049 LEUCHTEN S. 044-051	DECKENEINBAU
	AUFBAU	LEUCHTEN S. 054-089   PENDEL S. 090-095	AUFBAU
	WANDEINBAU	LEUCHTEN S. 098-101   LESELEUCHTEN S. 102-103	WANDEINBAU
	STRAHLER + STROMSCHIENEN	STRAHLER + LEUCHTEN + 3-PHASEN SCHIENE S. 106-114 STRAHLER + LEUCHTEN + VOLARE SCHIENE S. 115-125	STRAHLER + STROMSCHIENEN
	OFFICE	PENDELLEUCHTEN S. 128-129   PANELLEUCHTEN S. 130-133 AUFBAULEUCHTEN S. 134-137	OFFICE
	TECHNISCHE BELEUCHTUNG	TRAGSCHIENENSYSTEM S. 140-171   FEUCHTRAUMLEUCHTEN S. 172-179 HALLENREFLEKTORLEUCHTEN S. 180-187   NOT- + EINZELLEUCHTEN S. 188-189	TECHNISCHE BELEUCHTUNG
	LED SYSTEME	LED STRIPES S. 192-215   PROFILE S. 216-225 KONVERTER + STEUERUNGEN S. 226-229	LED SYSTEME INNEN + AUSSEN
	EINBAULEUCHTEN AUSSEN	WANDEINBAU S. 232-233   DECKENEINBAU S. 234-237	EINBAULEUCHTEN AUSSEN
	AUFBAULEUCHTEN AUSSEN	WANDAUFBAU S. 240-247   DECKENAUFBAU S. 248-253	AUFBAULEUCHTEN AUSSEN
	STEHLEUCHTEN AUSSEN	POLLER S. 256-263 MAST S. 264-269	STEHLEUCHTEN AUSSEN
	FLUTER + STRAHLER AUSSEN	FLUTER S. 272-275 STRAHLER S. 276-281	FLUTER + STRAHLER
	BETRIEBSGERÄTE	TRANSFORMATOREN S. 282   KONVERTER S. 283-289 STEUERUNGEN S. 290-293	BETRIEBSGERÄTE
	ZUBEHÖR	IP-VERBINDUNGEN + FASSUNGEN S. 294	ZUBEHÖR
	LED-RETROFITS + LEUCHTMITTEL	LED-RETROFITS + LEUCHTMITTEL S. 296-297	LED RETROFITS + LEUCHTMITTEL
	INFO	ALLGEMEINE INFORMATIONEN S. 298-312	INFO

INNENBELEUCHTUNG

AUSSENBELEUCHTUNG

TECHNIK

# DECKENEINBAU





### PONTOS SQUARE

INFORMATION	LUMEN / W BEI 250mA	LUMEN / W BEI 350mA	CRI>	KELVIN	L x B x ET	DA	FARBE	REFL.	ART.NR.
	LED 10W	LED 15W							
Einbaustrahler, Aluminiumdruckguss, pulverbeschichtet, quadratisch, schwenkbar 30°, zurück- versetzte Lichtquelle, exkl. Konverter	810	1250	80	2700	90 x 90 x 110	83 x 83	weiß	24°	305-624824w27k
	810	1250	80	2700	90 x 90 x 110	83 x 83	schwarz	24°	305-624824b27k
	870	1310	80	3000	90 x 90 x 110	83 x 83	weiß	24°	305-624824w
	870	1310	80	3000	90 x 90 x 110	83 x 83	schwarz	24°	305-624824b
	870	1310	80	4000	90 x 90 x 110	83 x 83	weiß	24°	305-624824w40k
	870	1310	80	4000	90 x 90 x 110	83 x 83	schwarz	24°	305-624824b40k
	810	1250	80	2700	90 x 90 x 110	83 x 83	weiß	36°	305-624836w27k
	810	1250	80	2700	90 x 90 x 110	83 x 83	schwarz	36°	305-624836b27k
	870	1310	80	3000	90 x 90 x 110	83 x 83	weiß	36°	305-624836w
	870	1310	80	3000	90 x 90 x 110	83 x 83	schwarz	36°	305-624836b
	870	1310	80	4000	90 x 90 x 110	83 x 83	weiß	36°	305-624836w40k
	870	1310	80	4000	90 x 90 x 110	83 x 83	schwarz	36°	305-624836b40k



### SATOR SQUARE R

INFORMATION	LEISTUNG	mA	LUMEN	CRI>	KELVIN	L x B x ET	DA L x B	FARBE	REFL.	ART.NR.
Einbaustrahler, Aluminiumdruckguss, Feinstruktur matt pulverbeschichtet, schwenkbar, zurück- versetzte Lichtquelle, exkl. Konverter	LED 10W	250	600	90	2700	72 x 72 x 119	68 x 68	weiß	24°	305-30023500
	LED 10W	250	600	90	2700	72 x 72 x 119	68 x 68	schwarz	24°	305-30023600
	LED 10W	250	620	90	3000	72 x 72 x 119	68 x 68	weiß	24°	305-30029500
	LED 10W	250	620	90	3000	72 x 72 x 119	68 x 68	schwarz	24°	305-30029600



KONVERTER PONTOS / SATOR	INFORMATION	WATT	mA	V DC	V AC	L x B x H	FARBE	ART.NR.
	nicht dimmbar	11W / 17W	250 / 350	44	230	147 x 44 x 22	weiß	24-127570
	DALI dimmbar	11W / 17W	250 / 350	49	230	111 x 52 x 22	weiß	24-151403



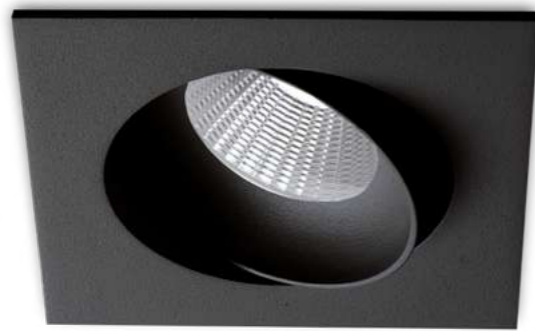

### KALIO SQUARE R

INFORMATION	LEISTUNG	mA	LUMEN	CRI>	KELVIN	L x B x ET	DA L x B	FARBE	REFL.	ART.NR.
Einbaustrahler, Aluminiumdruckguss, Feinstruktur matt pulverbeschichtet, schwenkbar 45°, zurückversetzte Licht- quelle, exkl. Konverter	LED 8W	250	860	90	2700	96 x 96 x 83	80 x 80	weiß	24°	308-30023500
	LED 8W	250	860	90	2700	96 x 96 x 83	80 x 80	schwarz	24°	308-30023600
	LED 8W	250	860	90	2700	96 x 96 x 83	80 x 80	weiß	38°	308-30033500
	LED 8W	250	860	90	2700	96 x 96 x 83	80 x 80	schwarz	38°	308-30033600
	LED 8W	250	900	90	3000	96 x 96 x 83	80 x 80	weiß	24°	308-30029500
	LED 8W	250	900	90	3000	96 x 96 x 83	80 x 80	schwarz	24°	308-30029600
	LED 8W	250	900	90	3000	96 x 96 x 83	80 x 80	weiß	38°	308-30039500
	LED 8W	250	900	90	3000	96 x 96 x 83	80 x 80	schwarz	38°	308-30039600



### AGON SQUARE

INFORMATION	LEISTUNG	mA	LUMEN	CRI>	KELVIN	L x B x ET	Ø DA	FARBE	REFL.	ART.NR.
Einbaustrahler, Aluminiumdruckguss, gebürstet oder pulver- beschichtet, quadra- tisch, schwenkbar 30°, exkl. Konverter	LED 5W	250	500	80	2700	80 x 80 x 84	68	weiß	20°	305-0050680202705
	LED 5W	250	530	80	2700	80 x 80 x 84	68	schwarz	20°	305-0050680202706
	LED 5W	250	550	80	2700	80 x 80 x 84	68	Alu gebürstet	20°	305-0050680202715
	LED 5W	250	540	80	3000	80 x 80 x 84	68	weiß	20°	305-0050680203005
	LED 5W	250	520	80	3000	80 x 80 x 84	68	schwarz	20°	305-0050680203006
	LED 5W	250	560	80	3000	80 x 80 x 84	68	Alu gebürstet	20°	305-0050680203015
	LED 5W	250	555	80	2700	80 x 80 x 84	68	weiß	40°	305-0050680402705
	LED 5W	250	560	80	2700	80 x 80 x 84	68	schwarz	40°	305-0050680402706
	LED 5W	250	540	80	2700	80 x 80 x 84	68	Alu gebürstet	40°	305-0050680402715
	LED 5W	250	550	80	3000	80 x 80 x 84	68	weiß	40°	305-0050680403005
	LED 5W	250	575	80	3000	80 x 80 x 84	68	schwarz	40°	305-0050680403006
	LED 5W	250	605	80	3000	80 x 80 x 84	68	Alu gebürstet	40°	305-0050680403015



KONVERTER KALIO / AGON	INFORMATION	WATT	mA	V DC	V AC	L x B x H	FARBE	ART.NR.
	nicht dimmbar	11W	250	44	230	147 x 44 x 22	weiß	24-127570
	DALI dimmbar	11W	250	49	230	111 x 52 x 22	weiß	24-151403



**LIRO R**

INFORMATION	LEISTUNG	mA	LUMEN	CRI>	KELVIN	L x B x ET	DA L x B	FARBE	REFL.	ART.NR.
Einbaustrahler, Aluminiumdruckguss, Feinstruktur matt pulverbeschichtet, starr, zurückversetzte Lichtquelle, exkl. Kon- verter	LED 6W	500	460	90	2700	70 x 70 x 65	62 x 62	weiß/schwarz	10°	472-30003560
	LED 6W	500	460	90	2700	70 x 70 x 65	62 x 62	schwarz	10°	472-30003660
	LED 6W	500	460	90	2700	70 x 70 x 65	62 x 62	weiß/schwarz	30°	472-30013560
	LED 6W	500	460	90	2700	70 x 70 x 65	62 x 62	schwarz	30°	472-30013660
	LED 6W	500	500	90	3000	70 x 70 x 65	62 x 62	weiß/schwarz	10°	472-30009560
	LED 6W	500	500	90	3000	70 x 70 x 65	62 x 62	schwarz	10°	472-30009660
	LED 6W	500	500	90	3000	70 x 70 x 65	62 x 62	weiß/schwarz	30°	472-30019560
	LED 6W	500	500	90	3000	70 x 70 x 65	62 x 62	schwarz	30°	472-30019660



KONVERTER LIRO	INFORMATION	WATT	mA	V DC	V AC	L x B x H	FARBE	ART.NR.
	nicht dimmbar	23W	500	46	230	147 x 44 x 30	weiß	24-127532n
	DALI dimmbar	20W	500	40	230	111 x 52 x 22	weiß	24-151403

**COVER**

INFORMATION	LEISTUNG	mA	LUMEN	CRI>	KELVIN	L x B x ET	DA	FARBE	REFL.	ART.NR.
Einbaustrahler, Aluminiumdruckguss, pulverbeschichtet, quadratisch, sand- gestrahltes Schutz- glas, exkl. Konverter, Betoneinbaugehäuse und Abdeckung separat ordern	LED 6W	250	435	80	3000	89 x 89 x 108	76 x 76	weiß	---	305-0619150
	LED 6W	250	435	80	3000	89 x 89 x 108	76 x 76	grau	---	305-0619140
<b>ABDECKUNG INFO</b>	inkl. Zentrierteil DA: 78 x 78 mm, zu Betoneinbaugehäuse 332-1001, aus verzinktem Blech, nicht für Sichtbeton geeignet, passend für COVER					<b>ABBILDUNG</b>	<b>L x B x H</b>	<b>ART.NR.</b>		
							168 x 168 x 11	332-1302		
<b>BETONEINBAURAHMEN INFO</b>	ohne Abdeckung aus verzinktem Blech, nicht für Sichtbeton geeignet, je eine Schlauch-einführung DM 20mm links, rechts und rückseitig, Abdeckung separat ordern					<b>ABBILDUNG</b>	<b>L x B x H</b>	<b>ART.NR.</b>		
							170 x 170 x 116	332-1001		



KONVERTER COVER	INFORMATION	WATT	mA	V DC	V AC	L x B x H	FARBE	ART.NR.
	nicht dimmbar	11W	250	44	230	147 x 44 x 22	weiß	24-127570
	DALI dimmbar	12W	250	49	230	111 x 52 x 22	weiß	24-151403



Projekt: Wohnhaus, Österreich, Produkt: COVER



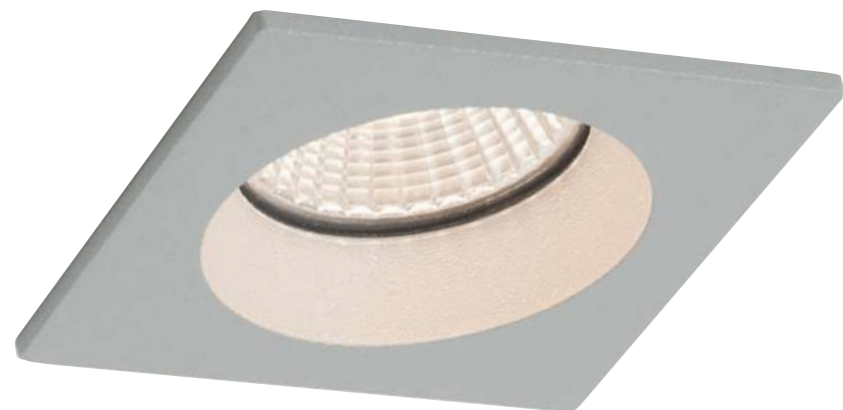

### CHICCO SQUARE

INFORMATION	LEISTUNG	mA	LUMEN	CRI>	KELVIN	L x B x ET	Ø DA	FARBE	REFL.	ART.NR.
Einbaustrahler, Aluminiumdruckguss, Feinstruktur matt pulverbeschichtet, starr, zurückversetzte Lichtquelle, 30° Ausstrahlwinkel, exkl. Konverter	LED 7W	350	530	90	2700	90 x 90 x 80	78	grau	30°	308-0020790302704
	LED 7W	350	540	90	2700	90 x 90 x 80	78	weiß	30°	308-0020790302705
	LED 7W	350	510	90	2700	90 x 90 x 80	78	schwarz	30°	308-0020790302706
	LED 7W	350	560	90	3000	90 x 90 x 80	78	grau	30°	308-0020790303004
	LED 7W	350	590	90	3000	90 x 90 x 80	78	weiß	30°	308-0020790303005
	LED 7W	350	560	90	3000	90 x 90 x 80	78	schwarz	30°	308-0020790303006



KONVERTER CHICCO	INFORMATION	WATT	mA	V DC	V AC	L x B x H	FARBE	ART.NR.
	nicht dimmbar	16W	350	46	230	147 x 44 x 30	weiß	24-127530n
	DALI dimmbar	17W	350	49	230	111 x 52 x 22	weiß	24-151403



### IVY SQUARE

INFORMATION	LEISTUNG	mA	LUMEN	CRI>	KELVIN	L x B x ET	Ø DA	FARBE	REFL.	ART.NR.
Einbaustrahler, Aluminiumdruckguss, weiß oder schwarz pulverbeschichtet, quadratisch, runder Deckenausschnitt, starr, zurückversetzte Lichtquelle, exkl. Konverter	LED 7W	200	700	90	3000	72 x 72 x 94	60	weiß	20°	472-0270790203005
	LED 7W	200	660	90	3000	72 x 72 x 94	60	schwarz	20°	472-0270790203006
	LED 7W	200	640	90	3000	72 x 72 x 94	60	weiß	40°	472-0270790403005
	LED 7W	200	630	90	3000	72 x 72 x 94	60	schwarz	40°	472-0270790403006



KONVERTER IVY	INFORMATION	WATT	mA	V DC	V AC	L x B x H	FARBE	ART.NR.
	nicht dimmbar	8,5W	200	44	230	147 x 44 x 22	weiß	24-127570
	DALI dimmbar	9,5W	180	53	230	111 x 52 x 22	weiß	24-123395



Projekt: Wohnhaus, Österreich, Produkt: CHICCO SQUARE



**STAR 3**

INFORMATION	LEISTUNG	mA	LUMEN	CRI>	KELVIN	L x B x ET	DA L x B	FARBE	REFL.	ART.NR.
Einbaustrahler, Diffusor aus satiniertem Glas, quadratisch, starr, exkl. Konverter, Einbaugehäuse für Gipskartonplatten, Beton oder Mauerwerk separat ordern.	LED 6W	350	529	80	3000	44 x 44 x 90	38 x 38	weiß	---	<b>68-669501WW</b>
	LED 6W	350	529	80	3000	44 x 44 x 90	38 x 38	schwarz	---	<b>68-669502WW</b>
	LED 6W	350	529	80	3000	44 x 44 x 90	38 x 38	gold satiniert	---	<b>68-669525WW</b>
	LED 6W	350	529	80	3000	44 x 44 x 90	38 x 38	nickel satiniert	---	<b>68-669532WW</b>



**STAR 4**

INFORMATION	LEISTUNG	mA	LUMEN	CRI>	KELVIN	L x B x ET	DA L x B	FARBE	REFL.	ART.NR.
Einbaustrahler, zurückversetzte Lichtquelle, quadratisch, starr, exkl. Konverter, Einbaugehäuse für Gipskartonplatten, Beton oder Mauerwerk separat ordern.	LED 6W	350	780	80	3000	44 x 44 x 105	38 x 38	weiß	40°	<b>68-669601WW40</b>
	LED 6W	350	780	80	3000	44 x 44 x 105	38 x 38	schwarz	40°	<b>68-669602WW40</b>
	LED 6W	350	780	80	3000	44 x 44 x 105	38 x 38	gold satiniert	40°	<b>68-669625WW40</b>
	LED 6W	350	780	80	3000	44 x 44 x 105	38 x 38	nickel satiniert	40°	<b>68-669632WW40</b>



KONVERTER STAR 3 / STAR 4	INFORMATION	WATT	mA	V DC	V AC	L x B x H	FARBE	ART.NR.
	nicht dimmbar	6W	350	22	230	60 x 35 x 21,5	weiß	<b>24-122598</b>
	DALI dimmbar (extern setzen)	19W	350	54	230	111 x 52 x 22	weiß	<b>24-122201</b>

EINBAUGEHÄUSE STAR 3 / STAR 4	INFORMATION	L x B	FARBE	ART.NR.
	quadratisches Einbaugehäuse für Gipskartonplatten	55 x 55	weiß	<b>68-020701</b>
			schwarz	<b>68-020702</b>

ABDECKUNG STAR 3 / STAR 4	INFORMATION	L x B x H	ART.NR.
	quadratische Abdeckung	90 x 90 x 7	<b>68-0224Q</b>
	verzinktes Blech. Achtung nicht geeignet für Sichtbeton		

EINBAUGEHÄUSE STAR 3 / STAR 4	INFORMATION	L x B x ET	ART.NR.
	quadratisches Einbaugehäuse für Beton	90 x 90 x 90	<b>68-0223</b>
	quadratisches Einbaugehäuse für Mauerwerk	90 x 60 x 90	<b>68-0225</b>



**STAR 1**

INFORMATION	LEISTUNG	mA	LUMEN	CRI>	KELVIN	Ø x ET	Ø DA	FARBE	REFL.	ART.NR.
Einbaustrahler, rund, starr, exkl. Konverter, Einbaugehäuse für Gipskartonplatten, Beton- oder Mauerwerk separat ordern.	LED 6W	350	780	80	3000	44 x 88	40	weiß	40°	<b>68-669001WW40</b>
	LED 6W	350	780	80	3000	44 x 88	40	schwarz	40°	<b>68-669002WW40</b>
	LED 6W	350	780	80	3000	44 x 88	40	gold satiniert	40°	<b>68-669025WW40</b>
	LED 6W	350	780	80	3000	44 x 88	40	nickel satiniert	40°	<b>68-669032WW40</b>



**STAR 2**

INFORMATION	LEISTUNG	mA	LUMEN	CRI>	KELVIN	Ø x ET	Ø DA	FARBE	REFL.	ART.NR.
Einbaustrahler, zurückversetzte Lichtquelle, rund, starr, exkl. Konverter, Einbaugehäuse für Gipskartonplatten, Beton oder Mauerwerk separat ordern.	LED 6W	350	780	80	3000	44 x 108	40	weiß	40°	<b>68-669101WW40</b>
	LED 6W	350	780	80	3000	44 x 108	40	schwarz	40°	<b>68-669102WW40</b>
	LED 6W	350	780	80	3000	44 x 108	40	gold satiniert	40°	<b>68-669125WW40</b>
	LED 6W	350	780	80	3000	44 x 108	40	nickel satiniert	40°	<b>68-669132WW40</b>



KONVERTER STAR 1 / STAR 2	INFORMATION	WATT	mA	V DC	V AC	L x B x H	FARBE	ART.NR.
	nicht dimmbar	6W	350	22	230	60 x 35 x 21,5	weiß	<b>24-122598</b>
	DALI dimmbar (extern setzen)	19W	350	54	230	111 x 52 x 22	weiß	<b>24-122201</b>

EINBAUGEHÄUSE STAR 1 / STAR 2	INFORMATION	Ø	FARBE	ART.NR.
	quadratisches Einbaugehäuse für Gipskartonplatten	67	weiß	<b>68-020601</b>
			schwarz	<b>68-020602</b>

ABDECKUNG STAR 1 / STAR 2	INFORMATION	L x B x H	ART.NR.
	runde Abdeckung	90 x 90 x 7	<b>68-0224C</b>
	verzinktes Blech. Achtung nicht geeignet für Sichtbeton		

EINBAUGEHÄUSE STAR 1 / STAR 2	INFORMATION	L x B x ET	ART.NR.
	quadratisches Einbaugehäuse für Beton	90 x 90 x 90	<b>68-0223</b>
	quadratisches Einbaugehäuse für Mauerwerk	90 x 60 x 90	<b>68-0225</b>



## PONTOS ROUND

INFORMATION	LUMEN / W BEI 250mA	LUMEN / W BEI 350mA	CRI>	KELVIN	Ø x ET	Ø DA	FARBE	REFL.	ART.NR.
	LED 10W	LED 15W							
Einbaustrahler, Aluminiumdruckguss, weiß oder schwarz pulverbeschichtet, schwenkbar 30°, zurückversetzte Lichtquelle, exkl. Konverter	805	1245	80	2700	90 x 110	83	weiß	24°	305-619924w27k
	805	1245	80	2700	90 x 110	83	schwarz	24°	305-619924b27k
	840	1280	80	3000	90 x 110	83	weiß	24°	305-619924w
	840	1280	80	3000	90 x 110	83	schwarz	24°	305-619924b
	840	1280	80	4000	90 x 110	83	weiß	24°	305-619924w40k
	840	1280	80	4000	90 x 110	83	schwarz	24°	305-619924b40k
	805	1245	80	2700	90 x 110	83	weiß	36°	305-619936w27k
	805	1245	80	2700	90 x 110	83	schwarz	36°	305-619936b27k
	840	1280	80	3000	90 x 110	83	weiß	36°	305-619936w
	840	1280	80	3000	90 x 110	83	schwarz	36°	305-619936b
	840	1280	80	4000	90 x 110	83	weiß	36°	305-619936w40k
	840	1280	80	4000	90 x 110	83	schwarz	36°	305-619936b40k



## SATOR ROUND R

INFORMATION	LEISTUNG	mA	LUMEN	CRI>	KELVIN	Ø x ET	Ø DA	FARBE	REFL.	ART.NR.
	LED 10W	250	600							
Einbaustrahler, Aluminiumdruckguss, Feinstruktur matt pulverbeschichtet, schwenkbar, zurückversetzte Lichtquelle, exkl. Konverter	LED 10W	250	600	90	2700	72 x 119	68	weiß	24°	305-30013500
	LED 10W	250	600	90	2700	72 x 119	68	schwarz	24°	305-30013600
	LED 10W	250	620	90	3000	72 x 119	68	weiß	24°	305-30019500
	LED 10W	250	620	90	3000	72 x 119	68	schwarz	24°	305-30019600



KONVERTER PONTOS / SATOR	INFORMATION	WATT	mA	V DC	V AC	L x B x H	FARBE	ART.NR.
	nicht dimmbar	11W / 17W	250 / 350	44	230	147 x 44 x 22	weiß	24-127570
	DALI dimmbar	11W / 17W	250 / 350	49	230	111 x 52 x 22	weiß	24-151403



## LOOK ROUND

INFORMATION	LEISTUNG	mA	LUMEN	CRI>	KELVIN	Ø x ET	Ø DA	FARBE	REFL.	ART.NR.
	LED 7W	350	535							
Einbaustrahler, Aluminiumdruckguss, weiß pulverbeschichtet, rund, starr, zurückversetzte Lichtquelle, exkl. Konverter	LED 7W	350	535	90	3000	79 x 130	73	weiß	20°	472-291010wr
	LED 11W	350	950	90	3000	114 x 173	105	weiß	30°	472-0321090303005



KONVERTER LOOK	INFORMATION	WATT	mA	V DC	V AC	L x B x H	FARBE	ART.NR.
	nicht dimmbar	16W	350	46	230	147 x 44 x 30	weiß	24-127530n
	DALI dimmbar	17W	350	49	230	111 x 52 x 22	weiß	24-151403





### KALIO ROUND R

INFORMATION	LEISTUNG	mA	LUMEN	CRI>	KELVIN	Ø x ET	Ø DA	FARBE	REFL.	ART.NR.
Einbaustrahler, Aluminiumdruckguss, Feinstruktur matt pulverbeschichtet, schwenkbar, zurückversetzte Lichtquelle, exkl. Konverter	LED 8W	250	860	90	2700	96 x 83	80	weiß	24°	308-30003500
	LED 8W	250	860	90	2700	96 x 83	80	schwarz	24°	308-30003600
	LED 8W	250	860	90	2700	96 x 83	80	weiß	38°	308-30013500
	LED 8W	250	860	90	2700	96 x 83	80	schwarz	38°	308-30013600
	LED 8W	250	900	90	3000	96 x 83	80	weiß	24°	308-30009500
	LED 8W	250	900	90	3000	96 x 83	80	schwarz	24°	308-30009600
	LED 8W	250	900	90	3000	96 x 83	80	weiß	38°	308-30019500
	LED 8W	250	900	90	3000	96 x 83	80	schwarz	38°	308-30019600



### AGON ROUND

INFORMATION	LEISTUNG	mA	LUMEN	CRI>	KELVIN	Ø x ET	Ø DA	FARBE	REFL.	ART.NR.
Einbaustrahler, Kühlkörper Aluminiumdruckguss, gebürstet oder pulverbeschichtet, schwenkbar, rund, exkl. Konverter, kompatibel mit HALOX Betoneinbaudose und Frontteil DM 68mm	LED 5W	250	500	80	2700	80 x 70	68	weiß	20°	305-0040680202705
	LED 5W	250	530	80	2700	80 x 70	68	schwarz	20°	305-0040680202706
	LED 5W	250	550	80	2700	80 x 70	68	Alu gebürstet	20°	305-0040680202715
	LED 5W	250	540	80	3000	80 x 70	68	weiß	20°	305-0040680203005
	LED 5W	250	520	80	3000	80 x 70	68	schwarz	20°	305-0040680203006
	LED 5W	250	560	80	3000	80 x 70	68	Alu gebürstet	20°	305-0040680203015
	LED 5W	250	555	80	2700	80 x 70	68	weiß	40°	305-0040680402705
	LED 5W	250	560	80	2700	80 x 70	68	schwarz	40°	305-0040680402706
	LED 5W	250	540	80	2700	80 x 70	68	Alu gebürstet	40°	305-0040680402715
	LED 5W	250	550	80	3000	80 x 70	68	weiß	40°	305-0040680403005
	LED 5W	250	575	80	3000	80 x 70	68	schwarz	40°	305-0040680403006
	LED 5W	250	605	80	3000	80 x 70	68	Alu gebürstet	40°	305-0040680403015



KONVERTER KALIO / AGON	INFORMATION	WATT	mA	V DC	V AC	L x B x H	FARBE	ART.NR.
	nicht dimmbar	11W	250	44	230	147 x 44 x 22	weiß	24-127570
	DALI dimmbar	12W	250	49	230	111 x 52 x 22	weiß	24-151403



Bildretusche, Shutterstock, Produkt: AGON



### IVY ROUND

#### INFORMATION

Einbaustrahler, Aluminiumdruckguss, weiß oder schwarz matt feinstruktur pulverbeschichtet, rund, starr, zurückversetzte Lichtquelle, exkl. Konverter

LEISTUNG	mA	LUMEN	CRI>	KELVIN	Ø x ET	Ø DA	FARBE	REFL.	ART.NR.
LED 7W	200	700	90	3000	72 x 94	60	weiß	20°	472-0260790203005
LED 7W	200	660	90	3000	72 x 94	60	schwarz	20°	472-0260790203006
LED 7W	200	670	90	3000	72 x 94	60	weiß	40°	472-0260790403005
LED 7W	200	620	90	3000	72 x 94	60	schwarz	40°	472-0260790403006



#### KONVERTER IVY



INFORMATION	WATT	mA	V DC	V AC	L x B x H	FARBE	ART.NR.
nicht dimmbar	8,5W	200	44	230	147 x 44 x 22	weiß	24-127570
DALI dimmbar	9,5W	180	53	230	111 x 52 x 22	weiß	24-123395



### CHICCO ROUND

#### INFORMATION

Einbaustrahler, Aluminiumdruckguss Feinstruktur matt pulverbeschichtet, starr, zurückversetzte Lichtquelle, 30° Ausstrahlwinkel, exkl. Konverter

LEISTUNG	mA	LUMEN	CRI>	KELVIN	Ø x ET	DA Ø	FARBE	REFL.	ART.NR.
LED 7W	350	530	90	2700	90 x 80	78	grau	30°	308-0010790302704
LED 7W	350	540	90	2700	90 x 80	78	weiß	30°	308-0010790302705
LED 7W	350	510	90	2700	90 x 80	78	schwarz	30°	308-0010790302706
LED 7W	350	560	90	3000	90 x 80	78	grau	30°	308-0010790303004
LED 7W	350	590	90	3000	90 x 80	78	weiß	30°	308-0010790303005
LED 7W	350	560	90	3000	90 x 80	78	schwarz	30°	308-0010790303006



#### LKONVERTER CHICCO



INFORMATION	WATT	mA	V DC	V AC	L x B x H	FARBE	ART.NR.
nicht dimmbar	16W	350	46	230	147 x 44 x 33	weiß	24-127530n
DALI dimmbar	17W	350	49	230	111 x 52 x 22	weiß	24-151403



Projekt: Hotel Aigo, Aigen, Österreich, Foto: Molto Luce, Produkt: CHICCO ROUND



### STAR IP

INFORMATION	LEISTUNG	mA	LUMEN	CRI>	KELVIN	Ø x ET	Ø DA	FARBE	REFL.	ART.NR.
Einbaustrahler, Diffusor aus satiniertem Glas, rund, starr, exkl. Konverter, Einbaugehäuse für Gipskartonplatten, Beton- oder Mauerwerk separat ordern.	LED 3W	150	106	80	3000	44 x 71	40	weiß	---	<b>68-669201WW</b>
	LED 3W	150	106	80	3000	44 x 71	40	schwarz	---	<b>68-669202WW</b>

KONVERTER STAR IP	INFORMATION	WATT	mA	V DC	V AC	L x B x H	FARBE	ART.NR.
	nicht dimmbar	6W	150	40	230	60 x 35 x 22	weiß	<b>24-122604</b>
	DALI dimmbar (extern setzen)	7,5W	140	54	230	111 x 52 x 21	weiß	<b>24-123395</b>

EINBAUGEHÄUSE FÜR STAR IP	INFORMATION	Ø DA	FARBE	ART.NR.
	rundes Einbaugehäuse für Gipskartonplatten	67	weiß	<b>68-020601</b>
			schwarz	<b>68-020602</b>

ABDECKUNG STAR IP	INFORMATION	L x B x H	ART.NR.
	runde Abdeckung verzinktes Blech. Achtung nicht geeignet für Sichtbeton	90 x 90 x 7	<b>68-0224C</b>

EINBAUGEHÄUSE STAR 1 / STAR 2	INFORMATION	L x B x ET	ART.NR.
	quadratisches Einbaugehäuse für Beton	90 x 90 x 90	<b>68-0223</b>
	quadratisches Einbaugehäuse für Mauerwerk	90 x 60 x 90	<b>68-0225</b>



### DITTO

INFORMATION	LEISTUNG	mA	LUMEN	CRI>	KELVIN	Ø x ET	Ø DA	FARBE	REFL.	ART.NR.
Einbaustrahler, Aluminiumdruckguss, weiß oder grau pulverbeschichtet, rund, sandgestrahltes Schutzglas, exkl. Konverter, Betoneinbaugehäuse und Abdeckung separat ordern	LED 6W	250	415	80	3000	92 x 108	76	weiß	---	<b>305-0719150</b>

ABDECKUNG INFO	ABBILDUNG	L x B x H	ART.NR.
inkl. Zentrierteil Ø DA: 78mm, zu Betoneinbaugehäuse 332-1001, aus verzinktem Blech, nicht für Sichtbeton geeignet, passend für DITTO		168 x 168 x 11	<b>332-1402</b>

BETONEINBAUGEHÄUSE INFO	ABBILDUNG	L x B x H	ART.NR.
ohne Abdeckung aus verzinktem Blech, nicht für Sichtbeton geeignet, je eine Schlauch-einführung DM 20mm links, rechts und rückseitig, Abdeckung separat ordern		170 x 170 x 116	<b>332-1001</b>



KONVERTER DITTO	INFORMATION	WATT	mA	V DC	V AC	L x B x H	FARBE	ART.NR.
	nicht dimmbar	11W	250	44	230	147 x 44 x 22	weiß	<b>24-127570</b>
	DALI dimmbar	12W	250	49	230	111 x 52 x 22	weiß	<b>24-151403</b>





## ELIX

INFORMATION	LEISTUNG	mA	LUMEN	CRI>	KELVIN	Ø x ET	Ø DA	FARBE	REFL.	ART.NR.	
Einbaustrahler, Aluminiumdruckguss, matt Feinstruktur pulverbeschichtet, Dekorring aus Kunststoff schwarz, Strahlerkopf 45° schwenk- und 355° drehbar, 33° Ausstrahlwinkel, exkl. Konverter	LED 9W	500	650	90	2700	110 x 91	102	weiß	33°	276-0010990332756	
	LED 9W	500	650	90	2700	110 x 91	102	schwarz	33°	276-0010990332706	
	LED 9W	500	770	90	3000	110 x 91	102	weiß	33°	276-0010990333056	
	LED 9W	500	770	90	3000	110 x 91	102	schwarz	33°	276-0010990333006	
DEKORRING INFO	ABBILDUNG		FARBE	Ø	ART.NR.						
Ring aus Kunststoff, gold oder weiß, für Elix, werkzeuglos wechselbar. (separat ordern)			gold	60	276-7000						
			weiß	60	276-7001						
WABENRASTER INFO	ABBILDUNG		FARBE	Ø	ART.NR.						
Wabenraster aus Metall, für Elix, werkzeuglos montierbar. (separat ordern)			schwarz	60	276-1002						



KONVERTER ELIX	INFORMATION	WATT	mA	V DC	V AC	L x B x H	FARBE	ART.NR.
	nicht dimmbar	23W	500	46	230	147 x 44 x 30	weiß	24-127532n
	DALI dimmbar	20W	500	40	230	111 x 52 x 22	weiß	24-151403



## ELIX MINI

INFORMATION	LEISTUNG	mA	LUMEN	CRI>	KELVIN	Ø x ET	Ø DA	FARBE	REFL.	ART.NR.	
Einbaustrahler, Aluminiumdruckguss, matt Feinstruktur pulverbeschichtet, Dekorring aus Kunststoff schwarz, Strahlerkopf 90° schwenk- und 350° drehbar, 34° Ausstrahlwinkel, exkl. Konverter	LED 6W	350	330	90	2700	70 x 125	64	weiß	34°	276-0130690342756	
	LED 6W	350	330	90	2700	70 x 125	64	schwarz	34°	276-0130690342706	
	LED 6W	350	340	90	3000	70 x 125	64	weiß	34°	276-0130690343056	
	LED 6W	350	340	90	3000	70 x 125	64	schwarz	34°	276-0130690343006	
DEKORRING INFO	ABBILDUNG		FARBE	Ø	ART.NR.						
Ring aus Kunststoff, gold oder weiß, für Elix mini, werkzeuglos wechselbar. (separat ordern)			gold	37,5	276-7002						
			weiß	37,5	276-7003						



KONVERTER ELIX MINI	INFORMATION	WATT	mA	V DC	V AC	L x B x H	FARBE	ART.NR.
	nicht dimmbar	16W	350	46	230	147 x 44 x 30	weiß	24-127530n
	DALI dimmbar	17W	350	49	230	111 x 52 x 22	weiß	24-151403



Projekt: Freiraum Freistadt, Österreich, Planung &amp; Umsetzung: Ben Elmecker, Foto: Martin Pröll, Produkt: ELIX MINI

**SERIE 2374 HV GU10**

INFORMATION	LM	FASSUNG	V AC	W	L x B x ET	DA L x B	FARBE	REFL.	ART.NR.
Einbaustrahler, Aluminiumdruckguss, pulverbeschichtet oder galvanisiert, quadratisch, schwenkbar 45°, inkl.30cm Kabel	RETROFIT	GU10	230	max. 9	96 x 96 x 130	80 x 80	chrom	---	<b>8-23744hv</b>
	RETROFIT	GU10	230	max. 9	96 x 96 x 130	80 x 80	weiß	---	<b>8-23747hv</b>
	RETROFIT	GU10	230	max. 9	96 x 96 x 130	80 x 80	nickel matt	---	<b>8-23746hv</b>

↓<sub>45°</sub>

**SERIE 348 HV GU10**

INFORMATION	LM	FASSUNG	V AC	W	L x B x ET	DA L x B	FARBE	REFL.	ART.NR.
Einbaustrahler, Aluminiumdruckguss, pulverbeschichtet oder galvanisiert, quadratisch, schwenkbar 30°, zurückversetzte Lichtquelle, inkl.30cm Kabel	RETROFIT	GU10	230	max. 9	90 x 90 x 145	80 x 80	weiß	---	<b>8-3487hv</b>
	RETROFIT	GU10	230	max. 9	90 x 90 x 145	80 x 80	nickel matt	---	<b>8-34846hv</b>

↓<sub>30°</sub>

**VISIBLE II HV GU10**

INFORMATION	LM	FASSUNG	V AC	W	L x B x ET	DA L x B	FARBE	REFL.	ART.NR.
Einbaustrahler, Aluminiumdruckguss, weiß, schwarz oder grau pulverbeschichtet, quadratisch, schwenkbar 30°, zurückversetzte Lichtquelle, Betoneinbaugehäuse und Abdeckung separat ordern	RETROFIT	GU10	230	max. 9	85 x 85 x 135	74 x 72	weiß	---	<b>305-1440w</b>
	RETROFIT	GU10	230	max. 9	85 x 85 x 135	74 x 72	grau	---	<b>305-1440s</b>
	RETROFIT	GU10	230	max. 9	85 x 85 x 135	74 x 72	schwarz	---	<b>305-1440b</b>

↓<sub>30°</sub>



ABDECKUNG INFO	ABBILDUNG	L x B x H	ART.NR.
inkl. Zentrierteil DA: 70 x 75mm, zu Betoneinbaugehäuse 332-1001, aus verzinktem Blech, nicht für Sichtbeton geeignet, passend für VISIBLE II HV		168 x 168 x 11	<b>332-1202</b>
BETONEINBAUGEHÄUSE INFO	ABBILDUNG	L x B x H	ART.NR.
ohne Abdeckung aus verzinktem Blech, nicht für Sichtbeton geeignet, je eine Schlauch-einführung DM 20mm links, rechts und rückseitig, Abdeckung separat ordern		170 x 170 x 116	<b>332-1001</b>



Projekt: Wohnhaus, Österreich, Foto: Molto Luce, Produkt: VISIBLE II HV





### SERIE 4236 HV GU10

INFORMATION	LM	FASSUNG	V AC	W	L x B x ET	Ø DA	FARBE	REFL.	ART.NR.
Einbaustrahler, Aluminiumdruckguss, pulverbeschichtet oder galvanisiert, quadratisch, runder Deckenausschnitt, schwenkbar 25°, inkl. 30cm Kabel, mit Bajonettverschluss	RETROFIT	GU10	230	max. 9	88 x 88 x 120	68	messing poliert	---	8-42361hv
	RETROFIT	GU10	230	max. 9	88 x 88 x 120	68	chrom	---	8-42364hv
	RETROFIT	GU10	230	max. 9	88 x 88 x 120	68	schwarz	---	8-42366hv
	RETROFIT	GU10	230	max. 9	88 x 88 x 120	68	weiß	---	8-42367hv
	RETROFIT	GU10	230	max. 9	88 x 88 x 120	68	nickel matt	---	8-423646hv

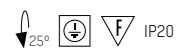

### QANA 1 GU10

INFORMATION	LM	FASSUNG	V AC	W	L x B x ET	DA L x B	FARBE	REFL.	ART.NR.
Einbauleuchte Kar-danisch, Aluminium gefräst, lackiert, weiß oder schwarz pulverbeschichtet, quadratisch, 350° dreh- / 30° schwenkbar	RETROFIT	GU10	230	max. 9	87 x 87 x 65	76 x 76	aluminium lackiert	---	472-259034hv
	RETROFIT	GU10	230	max. 9	87 x 87 x 65	76 x 76	weiß	---	472-25903405hv
	RETROFIT	GU10	230	max. 9	87 x 87 x 65	76 x 76	schwarz	---	472-25903406hv



### QANA 2 GU10

INFORMATION	LM	FASSUNG	V AC	W	L x B x ET	DA L x B	FARBE	REFL.	ART.NR.
Einbauleuchte Kar-danisch, Aluminium gefräst, lackiert, weiß oder schwarz pulverbeschichtet, quadratisch, 350° dreh- / 30° schwenkbar	RETROFIT	GU10	230	max. 9	174 x 87 x 65	165 x 76	aluminium lackiert	---	472-259035hv
	RETROFIT	GU10	230	max. 9	174 x 87 x 65	165 x 76	weiß	---	472-25903505hv
	RETROFIT	GU10	230	max. 9	174 x 87 x 65	165 x 76	schwarz	---	472-25903506hv



### EASY QUADRO GU10

INFORMATION	LM	FASSUNG	V AC	W	L x B x ET	DA L x B	FARBE	REFL.	ART.NR.
Einbaustrahler, Metall, pulverbeschichtet quadratisch, starr, satinier-tes Glas separat ordern	RETROFIT	GU10	230	max. 7	80 x 80 x 120	70 x 70	weiß	---	68-643201
	<b>GLAS INFO</b> Satinieretes Glas für Einbaustrahler Easy Quadro							<b>ABBILDUNG</b>	<b>ART.NR.</b>
									68-028801



Projekt: Hotel Die Hindenburg, Salfelden, Österreich, Foto: Molto Luce, Produkt: SERIE 4236 HV



### SERIE 68 HV GU10

INFORMATION	LM	FASSUNG	V AC	W	Ø x ET	Ø DA	FARBE	REFL.	ART.NR.
Einbaustrahler, Aluminiumdruckguss, pulverbeschichtet oder galvanisiert, quadra- tisch, runder Decken- ausschnitt, schwenk- bar 30°, inkl. 30cm Kabel, mit Bajonettver- schluss	RETROFIT	GU10	230	max. 9	82 x 120	70	messing poliert	---	8-681hv
	RETROFIT	GU10	230	max. 9	82 x 120	70	chrom	---	8-684hv
	RETROFIT	GU10	230	max. 9	82 x 120	70	schwarz	---	8-686hv
	RETROFIT	GU10	230	max. 9	82 x 120	70	weiß	---	8-687hv
	RETROFIT	GU10	230	max. 9	82 x 120	70	nickel matt	---	8-6846hv



### SERIE 332 HV GU10

INFORMATION	LM	FASSUNG	V AC	W	Ø x ET	Ø DA	FARBE	REFL.	ART.NR.
Einbaustrahler, Aluminiumdruckguss, pulverbeschichtet oder galvanisiert, rund, schwenkbar 25°, inkl. 30cm Kabel mit Bajo- nettverschluss	RETROFIT	GU10	230	max. 9	88 x 120	68	messing poliert	---	8-3321hv
	RETROFIT	GU10	230	max. 9	88 x 120	68	chrom	---	8-3324hv
	RETROFIT	GU10	230	max. 9	88 x 120	68	schwarz	---	8-3326hv
	RETROFIT	GU10	230	max. 9	88 x 120	68	weiß	---	8-3327hv
	RETROFIT	GU10	230	max. 9	88 x 120	68	nickel matt	---	8-33246hv



### SERIE 3391 HV GU10

INFORMATION	LM	FASSUNG	V AC	W	Ø x ET	Ø DA	FARBE	REFL.	ART.NR.
Einbaustrahler, Aluminiumdruck- guss, gebürstet, rund, schwenkbar 45°, inkl. 30cm Kabel	RETROFIT	GU10	230	max. 9	92 x 120	80	aluminium gebürstet	---	8-3391shv

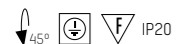

Projekt: Hotel Die Wasnerin, Bad Aussee, Österreich, Foto: Molto Luce, Produkt: SERIE 332 HV

**SERIE 146 HV GU10**

INFORMATION	LM	FASSUNG	V AC	W	Ø x ET	Ø DA	FARBE	REFL.	ART.NR.
Einbaustrahler, Aluminiumdruckguss, pulverbeschichtet oder galvanisiert, rund, starr, inkl.30cm Kabel	RETROFIT	GU10	230	max. 9	78 x 115	65	chrom	---	8-1464hv
	RETROFIT	GU10	230	max. 9	78 x 115	65	schwarz	---	8-1466hv
	RETROFIT	GU10	230	max. 9	78 x 115	65	weiß	---	8-1467hv
	RETROFIT	GU10	230	max. 9	78 x 115	65	nickel matt	---	8-14646hv

**SERIE 223 HV GU10**

INFORMATION	LM	FASSUNG	V AC	W	Ø x ET	Ø DA	FARBE	REFL.	ART.NR.
Einbaustrahler, Aluminiumdruckguss, pulverbeschichtet oder galvanisiert, rund, starr, inkl.30cm Kabel	RETROFIT	GU10	230	max. 9	81 x 125	68	weiß	---	8-2237hv
	RETROFIT	GU10	230	max. 9	81 x 125	68	nickel matt	---	8-22346hv
	RETROFIT	GU10	230	max. 9	81 x 125	68	schwarz	---	8-2235hv

**SERIE 3380 HV GU10**

INFORMATION	LM	FASSUNG	V AC	W	Ø x ET	Ø DA	FARBE	REFL.	ART.NR.
Einbaustrahler, Aluminiumdruckguss, pulverbeschichtet oder galvanisiert, rund, starr, inkl.30cm Kabel	RETROFIT	GU10	230	max. 9	82 x 150	75	schwarz	---	8-33806hv
	RETROFIT	GU10	230	max. 9	82 x 150	75	weiß	---	8-33807hv

**TAPPO GU10**

INFORMATION	LM	FASSUNG	V AC	W	Ø x ET	Ø DA	FARBE	REFL.	ART.NR.
Einbauleuchte, Aluminium pulverbeschichtet, starr, zurückversetzte Lichtquelle	RETROFIT	GU10	230	max. 7	85 x 160	79	weiss	---	68-632901
	RETROFIT	GU10	230	max. 7	85 x 160	79	schwarz	---	68-632902
	RETROFIT	GU10	230	max. 7	85 x 160	79	gold	---	68-632921
	RETROFIT	GU10	230	max. 7	85 x 160	79	gold satiniert	---	68-632925
	RETROFIT	GU10	230	max. 7	85 x 160	79	chrom	---	68-632931
	RETROFIT	GU10	230	max. 7	85 x 160	79	nickel satiniert	---	68-632932
	RETROFIT	GU10	230	max. 7	85 x 160	79	kupfer	---	68-632938

**SERIE 1101 HV GU10**

INFORMATION	LM	FASSUNG	V AC	W	Ø x ET	Ø DA	FARBE	REFL.	ART.NR.
Einbaustrahler, Aluminiumdruckguss, pulverbeschichtet oder galvanisiert, rund, starr, Schutzglas	RETROFIT	GU10	230	max. 9	84 x 120	74	chrom	---	8-1101b4hv
	RETROFIT	GU10	230	max. 9	84 x 120	74	schwarz	---	8-1101b6hv
	RETROFIT	GU10	230	max. 9	84 x 120	74	weiß	---	8-1101b7hv
	RETROFIT	GU10	230	max. 9	84 x 120	74	nickel matt	---	8-1101b46hv

**EASY TONDO GU10**

INFORMATION	LM	FASSUNG	V AC	W	Ø x ET	DA Ø	FARBE	REFL.	ART.NR.
Einbaustrahler, Metall, pulverbeschichtet, rund, starr, satiniertes Glas separat ordern	RETROFIT	GU10	230	max. 7	93 x 120	86	weiß	---	68-644201
	<b>GLAS INFO</b> Satiniertes Glas für Einbaustrahler Easy Tondo							<b>ABBILDUNG</b>	<b>ART.NR.</b>
									68-028901



Projekt: Wohnhaus, Österreich, Foto: Molto Luce, Produkt: SERIE 3380 HV



**MODUS**

INFORMATION	LEISTUNG	mA	LUMEN	CRI>	KELVIN	L x B x ET	Ø DA	FARBE	REFL.	ART.NR.
Einbaustrahler, Aluminiumdruckguss, eloxiert oder lackiert, Diffusor aus satiniertem Glas, eckig, starr, exkl. Konverter, geeignet für Einbau in Holz	LED 2W	500	199	80	3000	73 x 73 x 20	60	weiß	---	<b>68-639801ww</b>
	LED 2W	500	199	80	3000	73 x 73 x 20	60	gold	---	<b>68-639821ww</b>
	LED 2W	500	199	80	3000	73 x 73 x 20	60	chrom	---	<b>68-639831ww</b>
	LED 2W	500	199	80	3000	73 x 73 x 20	60	nickel matt	---	<b>68-639832ww</b>



**ZEN**

INFORMATION	LEISTUNG	mA	LUMEN	CRI>	KELVIN	Ø x ET	Ø DA	FARBE	REFL.	ART.NR.
Einbaustrahler, Aluminiumdruckguss, eloxiert oder lackiert, Diffusor aus satiniertem Glas, rund, starr, exkl. Konverter, geeignet für Einbau in Holz	LED 2W	500	199	80	3000	70 x 20	60	weiß	---	<b>68-636501ww</b>
	LED 2W	500	199	80	3000	70 x 20	60	gold	---	<b>68-636521ww</b>
	LED 2W	500	199	80	3000	70 x 20	60	chrom	---	<b>68-636531ww</b>
	LED 2W	500	199	80	3000	70 x 20	60	nickel matt	---	<b>68-636532ww</b>

EINBAUBOX INFO	ABBILDUNG	Ø x ET	ART.NR.
Deckeneinbauhülse, Kunststoff, für ZEN Leuchte		10 x 7,5	<b>68-0232</b>

KONVERTER MODUS / ZEN	INFORMATION	WATT	mA	V DC	V AC	L x B x H	FARBE	ART.NR.
	nicht dimmbar	6W	500	54	230	60 x 35 x 21,5	weiß	<b>24-122602</b>
	nicht dimmbar	20W	500	55	230	111 x 52 x 22	weiß	<b>24-122201</b>



**SERIE 015 G4**

INFORMATION	LM	FASSUNG	V AC	W	Ø x ET	Ø DA	FARBE	REFL.	ART.NR.
Einbaustrahler, Stahlblech, pulverbeschichtet oder galvanisiert, rund, starr, Schutzglas matt, 1m Silikonkabel exkl. Trafo	RETROFIT	G4	230	max. 4	72 x 50	55	messing poliert	---	<b>8-0151</b>
	RETROFIT	G4	230	max. 4	72 x 50	55	chrom	---	<b>8-0154</b>
	RETROFIT	G4	230	max. 4	72 x 50	55	weiß	---	<b>8-0157</b>
	RETROFIT	G4	230	max. 4	72 x 50	55	nickel matt	---	<b>8-01546</b>
	RETROFIT	G4	230	max. 4	72 x 50	55	schwarz	---	<b>8-0156</b>

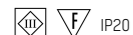

**ZHOOM R**

INFORMATION	LEISTUNG	mA	LUMEN	CRI>	KELVIN	Ø x H x ET	Ø DA	FARBE	REFL.	ART.NR.
Einbaustrahler, Aluminium, pulverbeschichtet oder galvanisiert, rund, schwenkbar, Glaslinse, stufenlos fokussierbar 10°-60°, exkl. Konverter	LED 2W	500	153	90	3000	49 x 12 x 41	42	chrom	---	<b>56-85034ng1</b>
	LED 2W	500	153	90	3000	49 x 12 x 41	42	perlchrom	---	<b>56-85037ng1</b>
	LED 2W	500	153	90	3000	49 x 12 x 41	42	schwarz	---	<b>56-85039ng1</b>
	LED 2W	500	163	90	4000	49 x 12 x 41	42	chrom	---	<b>56-85035ng1</b>
	LED 2W	500	163	90	4000	49 x 12 x 41	42	perlchrom	---	<b>56-85036ng1</b>
	LED 2W	500	163	90	4000	49 x 12 x 41	42	schwarz	---	<b>56-85038ng1</b>



LED KONVERTER	INFORMATION	WATT	mA	V DC	L x B x H	FARBE	ART.NR.
	nicht dimmbar	4W	500	54	51 x 32 x 18	schwarz	<b>75-mpl5</b>
	nicht dimmbar	20W	500	40	111* x 52 x 22	weiß	<b>24-122201</b>

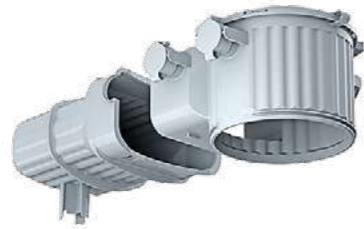

**HALOX-100 GEHÄUSE MIT TRAFOTUNNEL****INFORMATION**

Einbauhöhe inkl. Frontteil 120 mm, 4 Schlagkupplungen M20/25, Kombinationseinführung mit Rohreinführungsbegrenzung zur Vermeidung innerer Rohrkürzung, für Leuchten mit Einbaudurchmesser 0-100mm, max. Einbauhöhe Leuchte 110 mm, Lampenleistung LED max. 20 W, Lampenleistung NV/HV/TC max. 50W, Tunnel für Aufnahme von Betriebsgeräten in entsprechender Größe (Tunnel LxBxH = 190x140x85mm)

Ø	FARBE	ART.NR.
130	grau	113-128130

**HALOX-100 GEHÄUSE****INFORMATION**

Einbauhöhe inkl. Frontteil 120 mm, 2 Schlagkupplungen M20/25, Kombinationseinführung mit Rohreinführungsbegrenzung zur Vermeidung innerer Rohrkürzung, für Leuchten mit Einbaudurchmesser 0-100mm, max. Einbauhöhe Leuchte 110 mm, Lampenleistung LED max. 20 W, Lampenleistung NV/HV/TC max. 50W

Ø	FARBE	ART.NR.
130	grau	113-128100

**HALOX-100 UNIVERSALFRONTTEIL****INFORMATION**

variabler Deckenauslass mit Mineralfaserplatte, Deckenauslass bis Ø max. 100 mm stufenlos möglich, zeitsparend ohne weitere Nacharbeiten evtl. Oberfläche glätten

Ø	FARBE	ART.NR.
max. 100	grau	113-128111

**HALOX-100 UNIVERSALFRONTTEIL****INFORMATION**

variabler Deckenauslass für Ø von 0-100 mm

Ø	FARBE	ART.NR.
max. 100	grau	113-128110

**HALOX-100 FRONTTEILE****INFORMATION**

HALOX Frontteil für quadratischen Deckenauslass - verschiedene Ausführungen für entsprechende Außenabmessungen

L x B	FARBE	ART.NR.
68x68 (Leuchtenblende min. 75x75)	grau	113-128108
75x75 (Leuchtenblende min. 82x82)	grau	113-128109

**HALOX-100 FRONTTEILE****INFORMATION**

HALOX Frontteil für runden Deckenauslass - verschiedene Ausführungen für entsprechende Einbaudurchmesser

Ø	FARBE	ART.NR.
68 (Leuchtenblende min. 75)	grau	113-128101
75 (Leuchtenblende min. 82)	grau	113-128102
80 (Leuchtenblende min. 87)	grau	113-128103
85 (Leuchtenblende min. 92)	grau	113-128104
95 (Leuchtenblende min. 102)	grau	113-128106
100 (Leuchtenblende min. 107)	grau	113-128107

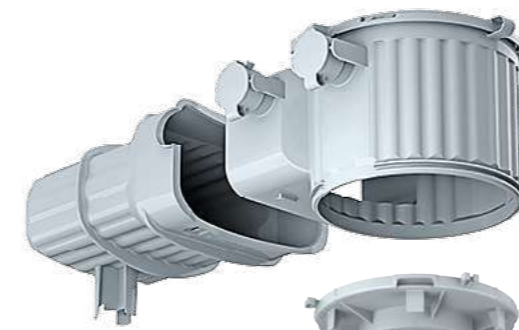
**BETON-EINBAUGEHÄUSE HALOX-100 FÜR ORTBETON****INFORMATION**

Für Halogenleuchten (Hochvolt und Niedervolt) und Lautsprecher in Ortbeton ab einer Deckenstärke von 160 mm steht Ihnen mit HaloX-0 ein umfangreiches Gehäusesystem zur Verfügung. Runde und quadratische Frontteile, Frontteile mit Mineralfaserplatten, Trafo-Tunnel und Zubehör ermöglichen vielfältige Einbaumöglichkeiten.

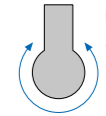

Gehäuse um 360° drehbar

**FRONTTEIL DECKENAUSLASS**

Ø 68 - 100  
 ø 68 x 68 mm  
 ø 75 x 75 mm

**MIN. Ø LEUCHTENBLENDE**

75 - 107  
 75 x 75 mm  
 82 x 82 mm

**UNIVERSAL-FRONTTEIL**

mit variablem Öffnungsmaß (DA) bis Ø 100 mm

**UNIVERSAL-FRONTTEIL MIT MINERalfaserplatte**

mit variablem Öffnungsmaß (DA) bis Ø 100 mm

**ABMESSUNGEN & INFO****INFORMATION**

- Starre und kardanbefestigte Leuchten
- Lampenleistung max. 50 W
- Nur geprüfte (DIN VDE 0711/ EN 60598) sowie mit  $\nabla$  oder  $\nabla/\nabla$  gekennzeichnete Leuchten verwenden.

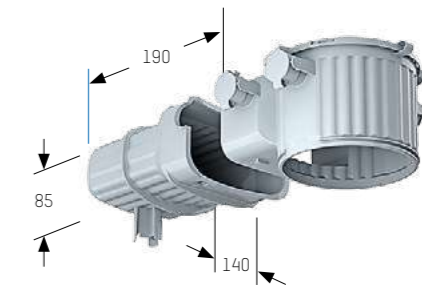
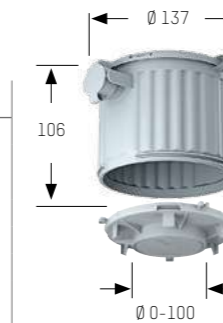



### SUNRAY I

INFORMATION	UGR<19		CRI>	KELVIN	Ø x ET	Ø DA	FARBE	REFL.	ART.NR.
	LUMEN / W BEI 250mA	LUMEN / W BEI 350mA							
Einbaustrahler in vier Größen, Aluminiumdruckguss, weiß matt pulverbeschichtet, Feinstruktur, passiv gekühlt, rund, starr, Schutzglas, exkl. Konverter	LED 10W	LED 14W	80	3000	105 x 105	95	weiß	36°	8-09519455
	1000	1400							
	1050	1500	80	4000	105 x 105	95	weiß	36°	8-09514455
<b>KONVERTER SEPARAT ORDERN</b>									
	24-127570	24-127530n	nicht dimmbar						
	24-151403	24-151403	DALI dimmbar						

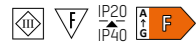

### SUNRAY II

INFORMATION	UGR<19			CRI>	KELVIN	Ø x ET	Ø DA	FARBE	REFL.	ART.NR.
	LUMEN / W BEI 350mA	LUMEN / W BEI 500mA	LUMEN / W BEI 700mA							
Einbaustrahler in vier Größen, Aluminiumdruckguss, weiß matt pulverbeschichtet, Feinstruktur, passiv gekühlt, rund, starr, Ausstrahlwinkel 45°, Schutzglas, exkl. Konverter	LED 14W	LED 20W	LED 28W	80	3000	140 x 113	125	weiß	45°	8-12519455
	1450	1950	2750							
	1550	2100	2900	80	4000	140 x 113	125	weiß	45°	8-12514455
<b>KONVERTER SEPARAT ORDERN</b>										
	24-127530n	24-127532n	24-127534n	nicht dimmbar						
	24-151403	24-127490	24-127490	DALI dimmbar						



### SUNRAY III

INFORMATION	UGR<19			CRI>	KELVIN	Ø x ET	Ø DA	FARBE	REFL.	ART.NR.
	LUMEN / W BEI 350mA	LUMEN / W BEI 500mA	LUMEN / W BEI 700mA							
Einbaustrahler in vier Größen, Aluminiumdruckguss, weiß matt pulverbeschichtet, Feinstruktur, passiv gekühlt, rund, starr, Schutzglas, exkl. Konverter	LED 14W	LED 20W	LED 29W	80	3000	165 x 113	150	weiß	45°	8-15019455
	1650	2250	2850							
	1750	2400	3000	80	4000	165 x 113	150	weiß	45°	8-15014455
<b>KONVERTER SEPARAT ORDERN</b>										
	24-127530n	24-127532n	24-127534n	nicht dimmbar						
	24-151403	24-127490	24-127490	DALI dimmbar						



### SUNRAY IV

INFORMATION	UGR<19			CRI>	KELVIN	Ø x ET	Ø DA	FARBE	REFL.	ART.NR.
	LUMEN / W BEI 500mA	LUMEN / W BEI 700mA	LUMEN / W BEI 1050mA							
Einbaustrahler in vier Größen, Aluminiumdruckguss, weiß matt pulverbeschichtet, Feinstruktur, passiv gekühlt, rund, starr, Schutzglas, exkl. Konverter	LED 21W	LED 29W	LED 43W	80	3000	230 x 140	205	weiß	50°	8-20519505
	2300	3050	4150							
	2400	3150	4300	80	4000	230 x 140	205	weiß	50°	8-20514505
<b>KONVERTER SEPARAT ORDERN</b>										
	24-127532n	24-127534n	24-122204	nicht dimmbar						
	24-127490	24-127490	24-15141350	DALI dimmbar						

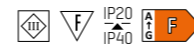

Projekt: Kurhotel Marienkron, Mönchhof, Österreich, Planung und Umsetzung: Mayr & Glatzl, Foto: Gabriel Büchelmeier, Produkt: SUNRAY II



### SPEAKER 1 / SPEAKER 2

INFORMATION	LEISTUNG	LUMEN	CRI>	KELVIN	Ø x ET	Ø DA	FARBE	REFL.	ART.NR.
Einbaustrahler, Aluminiumblech tiefgezogen, weiß lackiert, rund, einstellbare Stahlbügel, Diffusor Polycarbonat, inkl. Konverter, sichtbare Teile IP40, nicht sichtbare Teile IP20	SYS 14W	1200	80	3000	188 x 200	154-186	weiß	100°	121-2208441000
	SYS 14W	1300	80	4000	188 x 200	154-186	weiß	100°	121-2208441100
	SYS 25W	1900	80	3000	240 x 200	202-238	weiß	100°	121-2208441500
	SYS 25W	2000	80	4000	240 x 200	202-238	weiß	100°	121-2208441600

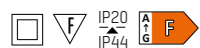

### ENERGY 2130 / 2180 / 2245

INFORMATION	LEISTUNG	LUMEN	CRI>	KELVIN	Ø x ET	Ø DA	FARBE	REFL.	ART.NR.
Einbaudownlightserie aus druckgegossenem Aluminium, weiß pulverbeschichtet, rund, starr, Diffusor aus Polycarbonat, inkl. Konverter	SYS 12W	900	90	3000	140 x 66	110-135	weiß	100°	121-2217231000
	SYS 12W	1000	90	4000	140 x 66	110-135	weiß	100°	121-2217231300
	SYS 14W	1302	90	3000	180 x 78	160-175	weiß	100°	121-2217251039
	SYS 14W	1400	90	4000	180 x 78	160-175	weiß	100°	121-2217251000
	SYS 19W	1860	90	3000	245 x 78	200-240	weiß	100°	121-2217221039
	SYS 19W	2000	90	4000	245 x 78	200-240	weiß	100°	121-2217221000



### SPEAKER 3 B

INFORMATION	LEISTUNG	LUMEN	CRI>	KELVIN	Ø x ET	Ø DA	FARBE	REFL.	ART.NR.
Einbaudownlight aus druckgegossenem Aluminium, weiß pulverbeschichtet, rund, starr, Diffusor aus Polycarbonat, inkl. Konverter	SYS 23W	1952	80	3000	225 x 108	190-220	weiß	100°	121-2208471000
	SYS 23W	2050	80	4000	225 x 108	190-220	weiß	100°	121-2208471100



Projekt: CC Amstetten, Österreich, Foto: Molto Luce, Produkt: ENERGY 2245



## MOON SQUARE

INFORMATION	LEISTUNG	mA	LUMEN	CRI>	KELVIN	L x B x ET	DA L x B	FARBE	REFL.	ART.NR.
Einbauleuchte, Aluminium, weiß matt lackiert, passiv gekühlt, quadratisch, sehr homogene Ausleuchtung, opaler Diffusor, extrem flach, exkl. Konverter, Achtung: ca. 30mm Platz für Konverter einplanen	LED 6W	250	730	80	3000	120 x 120 x 54	105 x 105	weiß matt	110°	139-0030680003005
	LED 6W	250	785	80	4000	120 x 120 x 54	105 x 105	weiß matt	110°	139-0030680004005
	LED 12W	500	1640	80	3000	175 x 175 x 54	160 x 160	weiß matt	114°	139-0041280003005
	LED 12W	500	1700	80	4000	175 x 175 x 54	160 x 160	weiß matt	114°	139-0041280004005
	LED 17W	700	2285	80	3000	300 x 300 x 54	275 x 275	weiß matt	114°	139-0051880003005
	LED 17W	700	2300	80	4000	300 x 300 x 54	275 x 275	weiß matt	114°	139-0051880004005

AUFBAUGEHÄUSE INFO	ABBILDUNG	FÜR	L x B x H	FARBE	ART.NR.
Aufbaugehäuse, Stahlblech, weiß matt lackiert, quadratisch, passend zu Moon Leuchte quadratisch, exkl. Leuchte und Konverter		MOON SQUARE 120	125 x 125 x 45	weiß opal	643-0001
		MOON SQUARE 175	180 x 180 x 45	weiß opal	643-0002
		MOON SQUARE 300	305 x 305 x 45	weiß opal	643-0003



KONVERTER	INFORMATION	WATT	mA	V DC	V AC	FÜR	L x B x H	FARBE	ART.NR.
	nicht dimmbar	13W	250	54	230	1 - 2 MOON 120	111 x 52 x 22	weiß	24-122201
	nicht dimmbar	20W	500	40	230	1 MOON 175	111 x 52 x 22	weiß	24-122201
	nicht dimmbar	20W	700	29	230	1 MOON 300	111 x 52 x 22	weiß	24-122201
	nicht dimmbar	6W	250	23	230	1 MOON 120 (AUFBAUGEHÄUSE)	42 x 40 x 22	schwarz	24-122812
	dimmbar DALI	12W	250	49	230	1 - 2 MOON 120	111 x 52 x 22	weiß	24-151403
	dimmbar DALI	20W	500	40	230	1 MOON 175	111 x 52 x 22	weiß	24-151403
	dimmbar DALI	20W	700	28	230	1 MOON 300	111 x 52 x 22	weiß	24-151403

Projekt: Wohnhaus, Österreich, Foto: Molto Luce, Produkt: MOON SQUARE



## MOON ROUND

INFORMATION	LEISTUNG	mA	LUMEN	CRI>	KELVIN	Ø x ET	Ø DA	FARBE	REFL.	ART.NR.
Einbauleuchte, Aluminium, weiß matt lackiert, passiv gekühlt, rund, sehr homogene Ausleuchtung, opaler Diffusor, extrem flach, exkl. Konverter, Achtung: ca. 30mm Platz für Konverter einplanen	LED 6W	250	770	80	3000	120 x 54	110	weiß matt	114°	139-0000680003005
	LED 6W	250	835	80	4000	120 x 54	110	weiß matt	114°	139-0000680004005
	LED 12W	500	1730	80	3000	175 x 54	160	weiß matt	114°	139-0011280003005
	LED 12W	500	1780	80	4000	175 x 54	160	weiß matt	114°	139-0011280004005
	LED 17W	700	2500	80	3000	300 x 54	285	weiß matt	113°	139-0021880003005
	LED 17W	700	2450	80	4000	300 x 54	285	weiß matt	113°	139-0021880004005

AUFBAUGEHÄUSE INFO	ABBILDUNG	FÜR	Ø x H	FARBE	ART.
Aufbaugehäuse, Stahlblech, weiß matt lackiert, rund, passend zu Moon Leuchte rund, exkl. Leuchte und Konverter		MOON ROUND 120	124 x 45	weiß opal	643-1001
		MOON ROUND 175	180 x 45	weiß opal	643-1002
		MOON ROUND 300	304 x 45	weiß opal	643-1003



KONVERTER	INFORMATION	WATT	mA	V DC	V AC	FÜR	L x B x H	FARBE	ART.NR.
	nicht dimmbar	13W	250	54	230	1 - 2 MOON 120	111 x 52 x 22	weiß	24-122201
	nicht dimmbar	20W	500	40	230	1 MOON 175	111 x 52 x 22	weiß	24-122201
	nicht dimmbar	20W	700	29	230	1 MOON 300	111 x 52 x 22	weiß	24-122201
	nicht dimmbar	6W	250	23	230	1 MOON 120 (AUFBAUGEHÄUSE)	42 x 40 x 22	schwarz	24-122812
	dimmbar DALI	12W	250	49	230	1 - 2 MOON 120	111 x 52 x 22	weiß	24-151403
	dimmbar DALI	20W	500	40	230	1 MOON 175	111 x 52 x 22	weiß	24-151403
	dimmbar DALI	20W	700	28	230	1 MOON 300	111 x 52 x 22	weiß	24-151403

Bildretusche, Foto: Shutterstock, Produkt: MOON ROUND





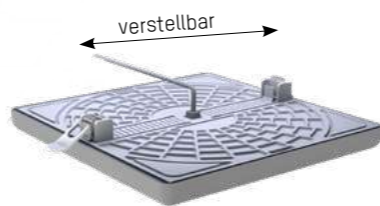
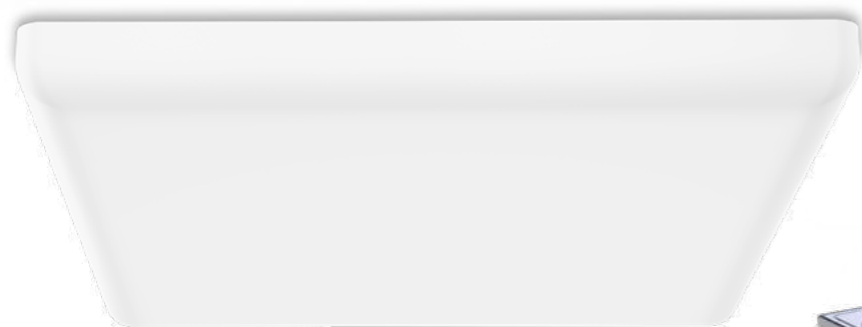

### MAAN SQUARE

INFORMATION	LEISTUNG	mA	LUMEN	CRI>	KELVIN*	L x B x ET	DA L x B	ART.NR.
Halbeinbauleuchte, Aluminium, weiß matt lackiert, passiv gekühlt, quadratisch, sehr homogene Ausleuchtung, opaler Diffusor, 118 grad Ausstrahlwinkel, Aufbauhöhe 20 mm, exkl. Konverter	LED 5W	250	718/762/743	80	2700/3300/4000	90 x 90 x 50	50x50 - 75x75	139-000209201105
	LED 13W	350	1888/2043/1952	80	2700/3300/4000	120 x 120 x 50	70x70 - 100x100	139-000212201105
	LED 18W	500	2786/2937/2853	80	2700/3300/4000	175 x 175 x 50	70x70 - 150x150	139-000218201105
	LED 32W	900	4915/5195/5062	80	2700/3300/4000	225 x 225 x 50	70x70 - 205x205	139-000223201105

\* Lichtfarbe mittels DIP-Switch einstellbar

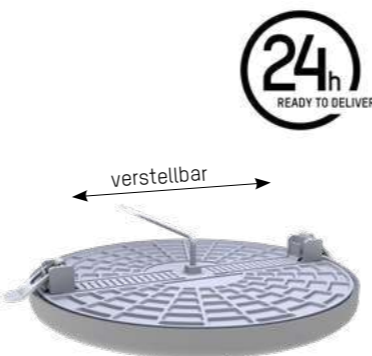



### MAAN ROUND

INFORMATION	LEISTUNG	mA	LUMEN	CRI>	KELVIN*	Ø x ET	Ø DA	ART.NR.
Halbeinbauleuchte, Aluminium, weiß matt lackiert, passiv gekühlt, quadratisch, sehr homogene Ausleuchtung, opaler Diffusor, 118 grad Ausstrahlwinkel, Aufbauhöhe 16 mm, exkl. Konverter	LED 5W	250	707/757/733	80	2700/3300/4000	90 x 50	50-75	139-000109201105
	LED 13W	350	1846/2008/1894	80	2700/3300/4000	120 x 50	70-100	139-000112201105
	LED 18W	500	2759/2919/2847	80	2700/3300/4000	175 x 50	70-150	139-000118201105
	LED 32W	900	4877/5192/5047	80	2700/3300/4000	225 x 50	70-205	139-000123201105

\* Lichtfarbe mittels DIP-Switch einstellbar



KONVERTER MAAN	INFORMATION	WATT	mA	V DC	L x B x H	ART.NR.
	nicht dimmbar	13-20W	250-700	57-28	111 x 52 x 22	weiß 24-122201
	DALI dimmbar	12-20W	250-700	47-28	111 x 52 x 22	weiß 24-151403
	nicht dimmbar	13-42W	300-1050	44-40	130 x 42 x 30	weiß 24-127484
	DALI dimmbar	16-36W	300-1050	54-34	147 x 44 x 30	weiß 24-127490



Bildretusche, Foto: iStock, Produkt: MAAN ROUND



### HALOX-180 GEHÄUSE MIT TUNNEL 190

#### INFORMATION

Einbauhöhe inkl. Frontteil 120 mm, 4 Schlagkupplungen M20/25, Kombinationseinführung mit Rohreinführungsbegrenzung zur Vermeidung innerer Rohrkürzung, für Leuchten mit Einbaudurchmesser 0-180mm, max. Einbauhöhe Leuchte 110 mm, Lampenleistung LED max. 35 W, Lampenleistung NV/HV/TC max. 75W, Tunnel für Aufnahme von Betriebsgeräten in entsprechender Größe (Tunnel LxBxH = 190x140x85mm)

Ø	FARBE	ART.NR.
210	grau	113-128230



### HALOX-180 GEHÄUSE

#### INFORMATION

Einbauhöhe inkl. Frontteil 120 mm, 2 Schlagkupplungen M20/25, Kombinationseinführung mit Rohreinführungsbegrenzung zur Vermeidung innerer Rohrkürzung, für Leuchten mit Einbaudurchmesser 0-180mm, max. Einbauhöhe Leuchte 110 mm, Lampenleistung LED max. 35 W, Lampenleistung NV/HV/TC max. 75W

Ø	FARBE	ART.NR.
210	grau	113-128200



### HALOX-180 UNIVERSALFRONTTEIL

#### INFORMATION

variabler Deckenauslass mit Mineralfaserplatte, Deckenauslass bis Ø max. 180 mm stufenlos möglich, zeitsparend ohne weitere Nacharbeiten evtl. Oberfläche glätten

Ø	FARBE	ART.NR.
max. 180	grau	113-128211



### HALOX-180 UNIVERSALFRONTTEIL

#### INFORMATION

variabler Deckenauslass für Ø von 0-180 mm

Ø	FARBE	ART.NR.
max. 180	grau	113-128210



### HALOX-180 FRONTTEILE

#### INFORMATION

HALOX Frontteil für runden Deckenauslass - verschiedene Ausführungen für entsprechende Einbaudurchmesser

Ø	FARBE	ART.NR.
100 (Leuchtenblende min. 107)	grau	113-128201
110 (Leuchtenblende min. 117)	grau	113-128202
125 (Leuchtenblende min. 132)	grau	113-128203
145 (Leuchtenblende min. 152)	grau	113-128204
160 (Leuchtenblende min. 167)	grau	113-128205
180 (Leuchtenblende min. 187)	grau	113-128206

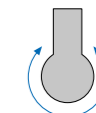

Gehäuse um 360° drehbar

### BETON-EINBAUGEHÄUSE HALOX-180 FÜR ORTBETON

#### INFORMATION

Für Leuchten und Lautsprecher in Ortbeton steht Ihnen mit HaloX ein umfangreiches Gehäusesystem zur Verfügung. Runde Frontteile, Frontteile mit Mineralfaserplatten, Trafo-Tunnel und Zubehör ermöglichen vielfältige Einbaumöglichkeiten.

FRONTTEIL DECKENAUSLASS	MIN. Ø LEUCHTENBLENDE
Ø 100 - 180	Ø 107 - 187

  

<p><b>UNIVERSAL-FRONTTEIL</b> mit variablem Öffnungsmaß (DA) bis Ø 180 mm</p>	
<p><b>UNIVERSAL-FRONTTEIL MIT MINERalfaserplatte</b> mit variablem Öffnungsmaß (DA) bis Ø 180 mm</p>	

### ABMESSUNGEN & INFO

#### INFORMATION

- Starre und kardanisch gelagerte Leuchten
- Lampenleistung max. 75 W
- Nur geprüfte (DIN VDE 0711/ EN 60598) sowie mit oder gekennzeichnete Leuchten verwenden.

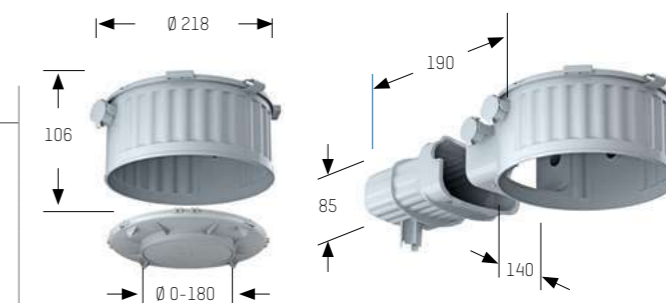

### UNIVERSAL BETONEINBAUGEHÄUSE

#### INFORMATION

Ohne Abdeckung aus verzinktem Blech, nicht für Sichtbeton geeignet, je eine Schlauch-einführung DM 20mm und 25mm links und rechts, Abdeckung separat ordern

L x B x H	ART.NR.
170 x 170 x 116	332-1001
450 x 303 x 136	332-2001



### ABDECKUNG RUND

#### INFORMATION

Abdeckung inkl. Zentrierteil zu Betoneinbaugehäuse 332-2001, aus verzinktem Blech, nicht für Sichtbeton geeignet

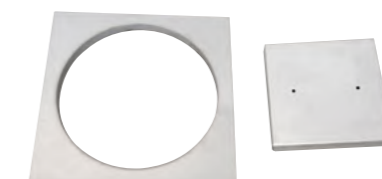



























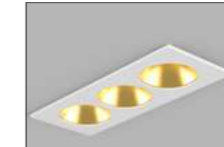









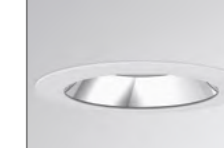

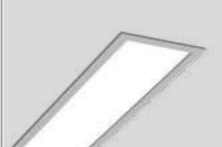

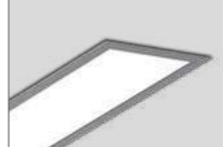
FÜR	L x B x H	Ø DA	ART.NR.
SPEAKER 1, ENERGY 2180	300 x 250 x 16	170	332-3r170



Projekt: Object Carpet GmbH / City of Visions, Denkendorf, Deutschland, Photo: Markus Guhl

# Weitere Einbauleuchten aus dem Molto Luce Programm

 GRID R 	 VIBO R 	 COZY R 	 BLINDSPOT TURN R 	 RIDE SPOT R 
 TRIGGA R 	 LITIN 2 R 	 DARK NIGHT TURN R 	 DARK NIGHT R 	 DARK NIGHT LENS R 
 SAVO R 	 NOW R ONLY R  	 MOVA R MOVA S R 	 2 GO R 	 GET R 
 LOG 50 R 	 LOG IN 2.1 R 	 RIDE R 	 BIDO R 	 BINA R 

# AUFBAU





## POLUS

INFORMATION	LEISTUNG	LUMEN	CRI>	KELVIN	L x B x H	FARBE	REFL.	ART.NR.
Aufbauleuchte, Aluminiumdruckguss, außen weiß / innen weiß bzw. außen schwarz / innen gold Feinstruktur, pulverbeschichtet, inkl. Konverter	SYS 11W	606	90	3000	105 x 105 x 105	weiß / weiß	---	276-0091190003005
	SYS 11W	580	90	3000	105 x 105 x 105	schwarz / gold	---	276-0091190003063

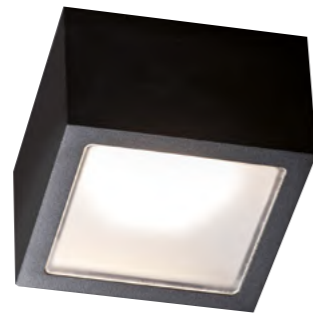
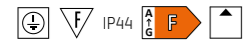

## UP AC

INFORMATION	LEISTUNG	LUMEN	CRI>	KELVIN	L x B x H	FARBE	REFL.	ART.NR.
Aufbauleuchte, AC-LED, Aluminium, weiß, schwarz oder silber Feinstruktur pulverbeschichtet, mit geschlossenem opalem Acryldiffusor, homogene Lichtverteilung	SYS 10W	576	90	2700	100 x 100 x 63	weiß	---	472-0501090002705
	SYS 10W	461	90	2700	100 x 100 x 63	schwarz	---	472-0501090002706
	SYS 10W	486	90	2700	100 x 100 x 63	silber	---	472-0501090002704
	SYS 10W	640	90	3000	100 x 100 x 63	weiß	---	472-0501090003005
	SYS 10W	515	90	3000	100 x 100 x 63	schwarz	---	472-0501090003006
	SYS 10W	540	90	3000	100 x 100 x 63	silber	---	472-0501090003004



## TILIS SD

INFORMATION	LEISTUNG	LUMEN	CRI>	KELVIN	L x B x H	FARBE	ART.NR.
Quadratische LED Aufbauleuchte aus Aluminium, matt Feinstruktur pulverbeschichtet, starr, zurückversetzte Lichtquelle, inkl. Konverter	SYS 10W	810	90	2700	130 x 70 x 50	weiß	472-20093500
	SYS 10W	810	90	2700	130 x 70 x 50	schwarz	472-20093600
	SYS 10W	810	90	2700	130 x 70 x 50	terra	472-20093200

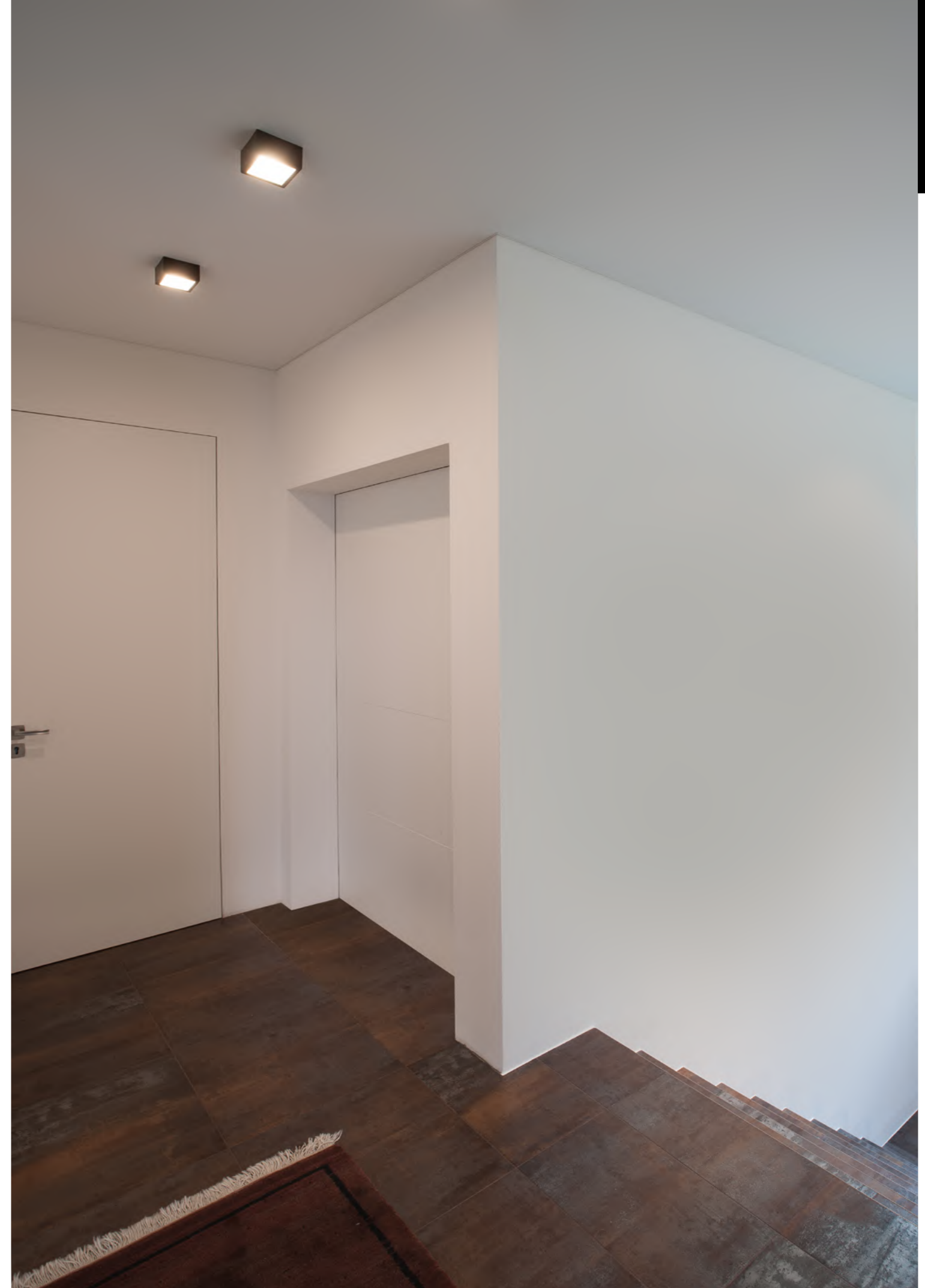

Projekt: Wohnhaus, Österreich, Foto: Molto Luce, Produkt: UP



**AEON SQUARE SMALL / AEON SQUARE BIG**

INFORMATION	LEISTUNG	LUMEN	CRI>	KELVIN	L x B x H	FARBE	REFL.	ART.NR.
Quadratische LED Aufbauleuchte aus Aluminium, matt Feinstruktur pulverbeschichtet, inkl. Konverter	SYS 6W	430	80	2700	80 x 80 x 95	weiß	45°	305-602427w
	SYS 6W	430	80	2700	80 x 80 x 95	schwarz	45°	305-602427b
	SYS 6W	495	80	3000	80 x 80 x 95	weiß	45°	305-602430w
	SYS 6W	495	80	3000	80 x 80 x 95	schwarz	45°	305-602430b
AEON BIG: DALI dimmbar	SYS 15W	1005	80	2700	120 x 120 x 158	weiß	50°	305-604427wddd
	SYS 15W	1005	80	2700	120 x 120 x 158	schwarz	50°	305-604427bddd
	SYS 15W	1180	80	3000	120 x 120 x 158	weiß	50°	305-604430wddd
	SYS 15W	1180	80	3000	120 x 120 x 158	schwarz	50°	305-604430bddd



**ATUS SINGLE SQUARE SD / ATUS SINGLE DOUBLE SD**

INFORMATION	LEISTUNG	LUMEN	CRI>	KELVIN	L x B x H	FARBE	REFL.	ART.NR.
LED Deckenaufbauleuchte aus Aluminium, pulverbeschichtet, starr, zurückversetzte Lichtquelle, inkl. Konverter	SYS 6W	480	90	3000	82 x 82 x 110	weiß	35°	472-20019560
	SYS 6W	480	90	3000	82 x 82 x 110	schwarz	35°	472-20019660
	SYS 6W	480	90	3000	82 x 82 x 110	terra	35°	472-20019260
	SYS 10W	880	90	3000	165 x 82 x 110	weiß	35°	472-20009560
	SYS 10W	880	90	3000	165 x 82 x 110	schwarz	35°	472-20009660
	SYS 10W	880	90	3000	165 x 82 x 110	terra	35°	472-20009260



**LIRO SD**

INFORMATION	LEISTUNG	LUMEN	CRI>	KELVIN	L x B x H	FARBE	REFL.	ART.NR.
Quadratische LED Aufbauleuchte aus Aluminium, pulverbeschichtet, starr, zurückversetzte Lichtquelle, inkl. Konverter	SYS 10W	620	90	2700	60 x 60 x 70	weiß/schwarz	10°	472-20073560
	SYS 10W	620	90	2700	60 x 60 x 70	schwarz	10°	472-20073660
	SYS 10W	620	90	2700	60 x 60 x 70	weiß/schwarz	30°	472-20083560
	SYS 10W	620	90	2700	60 x 60 x 70	schwarz	30°	472-20083660
	SYS 10W	650	90	3000	60 x 60 x 70	weiß/schwarz	10°	472-20079560
	SYS 10W	650	90	3000	60 x 60 x 70	schwarz	10°	472-20079660
	SYS 10W	650	90	3000	60 x 60 x 70	weiß/schwarz	30°	472-20089560
	SYS 10W	650	90	3000	60 x 60 x 70	schwarz	30°	472-20089660

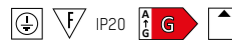

Projekt: Wohnhaus, Österreich, Foto: Rauch Joachi., Produkt: AEON SQUARE BIG

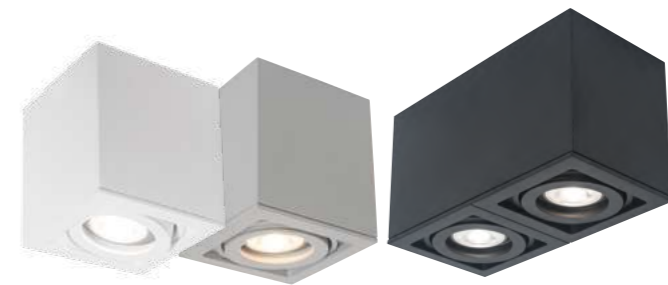

**QANA BOX I / QANA BOX II**

INFORMATION	LM	FASSUNG	V AC	W	L x B x H	FARBE	REFL.	ART.NR.
Aufbauleuchte 1-/2-flammig aus Aluminium, weiß, schwarz oder grau Feinstruktur pulverbeschichtet, Leuchtenkopf: Vollaluminium gefräst 30° dreh- / 30° schwenkbar	RETROFIT	GU10	230	max. 7	83 x 83 x 94	weiß	---	472-258951w
	RETROFIT	GU10	230	max. 7	83 x 83 x 94	schwarz	---	472-258951b
	RETROFIT	GU10	230	max. 7	83 x 83 x 94	silber matt	---	472-258951s
	2x RETROFIT	GU10	230	max. 7	165 x 83 x 90	weiß	---	472-258952w
	2x RETROFIT	GU10	230	max. 7	165 x 83 x 90	schwarz	---	472-258952b
	2x RETROFIT	GU10	230	max. 7	165 x 83 x 90	silber matt	---	472-258952s





### ARIK SHORT

#### INFORMATION

Aufbauleuchte, Aluminiumdruckguss, matt Feinstruktur pulverbeschichtet, zylindrisch, Acryldiffusor matt satiniert, inkl. Konverter

LEISTUNG	LUMEN	CRI>	KELVIN	Ø x H	FARBE	REFL.	ART.NR.
SYS 11W	360	90	3000	99 x 70	weiß	---	472-260029
SYS 11W	360	90	3000	99 x 70	schwarz	---	472-260030

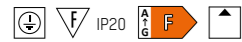

### CARMİ

#### INFORMATION

Aufbauleuchte, Aluminiumdruckguss, matt Feinstruktur pulverbeschichtet, zylindrisch, Acryldiffusor matt satiniert, inkl. Konverter

LEISTUNG	LUMEN	CRI>	KELVIN	Ø x H	FARBE	REFL.	ART.NR.
SYS 11W	550	90	2700	140 x 55	weiß	---	472-1227050
SYS 11W	455	90	2700	140 x 55	schwarz	---	472-1227060
SYS 11W	540	90	2700	140 x 55	schwarz / gold	---	472-12270630
SYS 11W	615	90	3000	140 x 55	weiß	---	472-1229050
SYS 11W	510	90	3000	140 x 55	schwarz	---	472-1229060
SYS 11W	540	90	3000	140 x 55	schwarz / gold	---	472-12290630

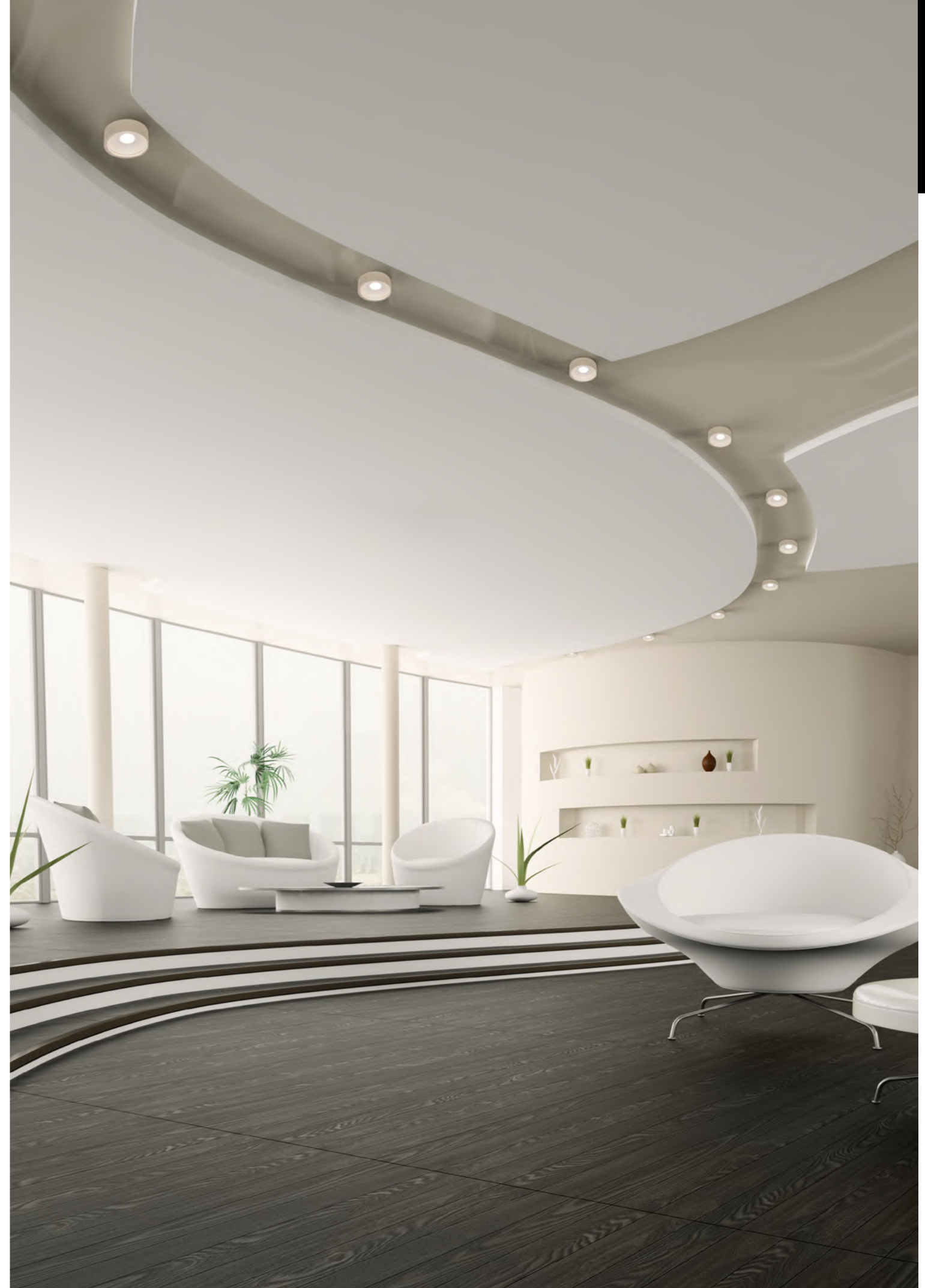

Bildretusche, Foto: Shutterstock, Produkt: CARMİ



**ATUS ROUND SD**

**INFORMATION**

LED Deckenaufbauleuchte aus Aluminium, matt Feinstruktur pulverbeschichtet, starr, Reflektor aus Kunststoff schwarz, zurückversetzte Lichtquelle, inkl. Konverter

LEISTUNG	LUMEN	CRI>	KELVIN	Ø x H	FARBE	REFL.	ART.NR.
SYS 6W	480	90	3000	72 x 110	weiß	35°	472-20029560
SYS 6W	480	90	3000	72 x 110	schwarz	35°	472-20029660
SYS 6W	480	90	3000	72 x 110	terra	35°	472-20029260



**AEON ROUND SMALL / AEON ROUND BIG**

**INFORMATION**

Runde LED Aufbauleuchte aus Aluminium, matt Feinstruktur pulverbeschichtet, inkl. Konverter

LEISTUNG	LUMEN	CRI>	KELVIN	Ø x H	FARBE	REFL.	ART.NR.
SYS 6W	475	80	2700	80 x 95	weiß	45°	305-602527w
SYS 6W	475	80	2700	80 x 95	schwarz	45°	305-602527b
SYS 6W	510	80	3000	80 x 95	weiß	45°	305-602530w
SYS 6W	510	80	3000	80 x 95	schwarz	45°	305-602530b
AEON BIG: DALI dimmbar							
SYS 15W	1015	80	2700	125 x 158	weiß	50°	305-604527wddd
SYS 15W	1015	80	2700	125 x 158	schwarz	50°	305-604527bddd
SYS 15W	1160	80	3000	125 x 158	weiß	50°	305-604530wddd
SYS 15W	1160	80	3000	125 x 158	schwarz	50°	305-604530bddd



**EGOTUBE GU10**

**INFORMATION**

Aufbauleuchte, Aluminium, pulverbeschichtet, rund, exkl. Leuchtmittel

LM	FASSUNG	V AC	W	Ø x H	FARBE	REFL.	ART.NR.
RETROFIT	GU10	230	max. 7	70 x 140	weiß	---	68-566001
RETROFIT	GU10	230	max. 7	70 x 140	schwarz	---	68-566002
RETROFIT	GU10	230	max. 7	70 x 210	weiß	---	68-566101
RETROFIT	GU10	230	max. 7	70 x 210	schwarz	---	68-566102



**CUT GU10**

**INFORMATION**

Aufbauleuchte, Aluminium, pulverbeschichtet, rund mit schräge Lichtaustrittsöffnung, exkl. Leuchtmittel



LM	FASSUNG	V AC	W	Ø x H	FARBE	REFL.	ART.NR.
RETROFIT	GU10	230	max. 7	70 x 210	weiß	---	68-566201
RETROFIT	GU10	230	max. 7	70 x 210	schwarz	---	68-566202





**MAGIS MINI SINGLE / MAGIS SINGLE**

INFORMATION	LEISTUNG	LUMEN	CRI>	KELVIN	Ø x H	FARBE	REFL.	ART.NR.
Aufbaustrahler, Aluminiumdruckguss, matt Feinstruktur pulverbeschichtet, Dekorring aus Metall (standardmäßig in Gehäusefarbe), Strahlerkopf 90° schwenk- und 350° drehbar, Reflektor (im Lieferumfang enthalten), Reflektor separat bestellbar, Wand- oder Deckenmontage, inkl. Konverter	SYS 11W	605	90	2700	75 x 91	weiß	50°	276-1127050
	SYS 11W	585	90	2700	75 x 91	schwarz	50°	276-1127060
	SYS 11W	615	90	3000	75 x 91	weiß	50°	276-1129050
	SYS 11W	600	90	3000	75 x 91	schwarz	50°	276-1129060
	SYS 16W	1160	90	2700	100 x 103	weiß	40°	276-0227050
	SYS 16W	1090	90	2700	100 x 103	schwarz	40°	276-0227060
	SYS 16W	1185	90	3000	100 x 103	weiß	40°	276-0229050
	SYS 16W	1070	90	3000	100 x 103	schwarz	40°	276-0229060

**MAGIS MINI DOUBLE / MAGIS DOUBLE**

INFORMATION	LEISTUNG	LUMEN	CRI>	KELVIN	L x B x H	FARBE	REFL.	ART.NR.
Aufbaustrahler 2-flammig, Aluminiumdruckguss, matt Feinstruktur pulverbeschichtet, Dekorring aus Metall (standardmäßig in Gehäusefarbe), Strahlerkopf 90° schwenk- und 350° drehbar, Reflektor (im Lieferumfang enthalten), Reflektor separat bestellbar, Wand- oder Deckenmontage, inkl. Konverter	SYS 22W	2x 615	90	2700	160 x 75 x 91	weiß	50°	276-1227050
	SYS 22W	2x 585	90	2700	160 x 75 x 91	schwarz	50°	276-1227060
	SYS 22W	2x 615	90	3000	160 x 75 x 91	weiß	50°	276-1229050
	SYS 22W	2x 585	90	3000	160 x 75 x 91	schwarz	50°	276-1229060
	SYS 30W	2x 1060	90	2700	212 x 100 x 103	weiß	40°	276-1027050
	SYS 30W	2x 1090	90	2700	212 x 100 x 103	schwarz	40°	276-1027060
	SYS 30W	2x 1185	90	3000	212 x 100 x 103	weiß	40°	276-1029050
	SYS 30W	2x 1070	90	3000	212 x 100 x 103	schwarz	40°	276-1029060

**MAGIS DEKORRING**

INFORMATION	FARBE	ART.NR. FÜR MAGIS MINI	ART.NR. FÜR MAGIS
Ring aus Metall pulverbeschichtet, weiß, schwarz oder gold, werkzeuglos wechselbar mit Magnethalterung. (separat ordern)	gold	276-7007	276-7004
	weiß	276-7008	276-7005
	schwarz	276-7009	276-7006

**MAGIS TAUSCHREFLEKTOR**

INFORMATION	REF	ART.NR. FÜR MAGIS MINI	ART.NR. FÜR MAGIS
Reflektor für Magis werkzeuglos wechselbar (separat ordern)	20°	276-7012	276-7010
	30°	276-7013	276-7011

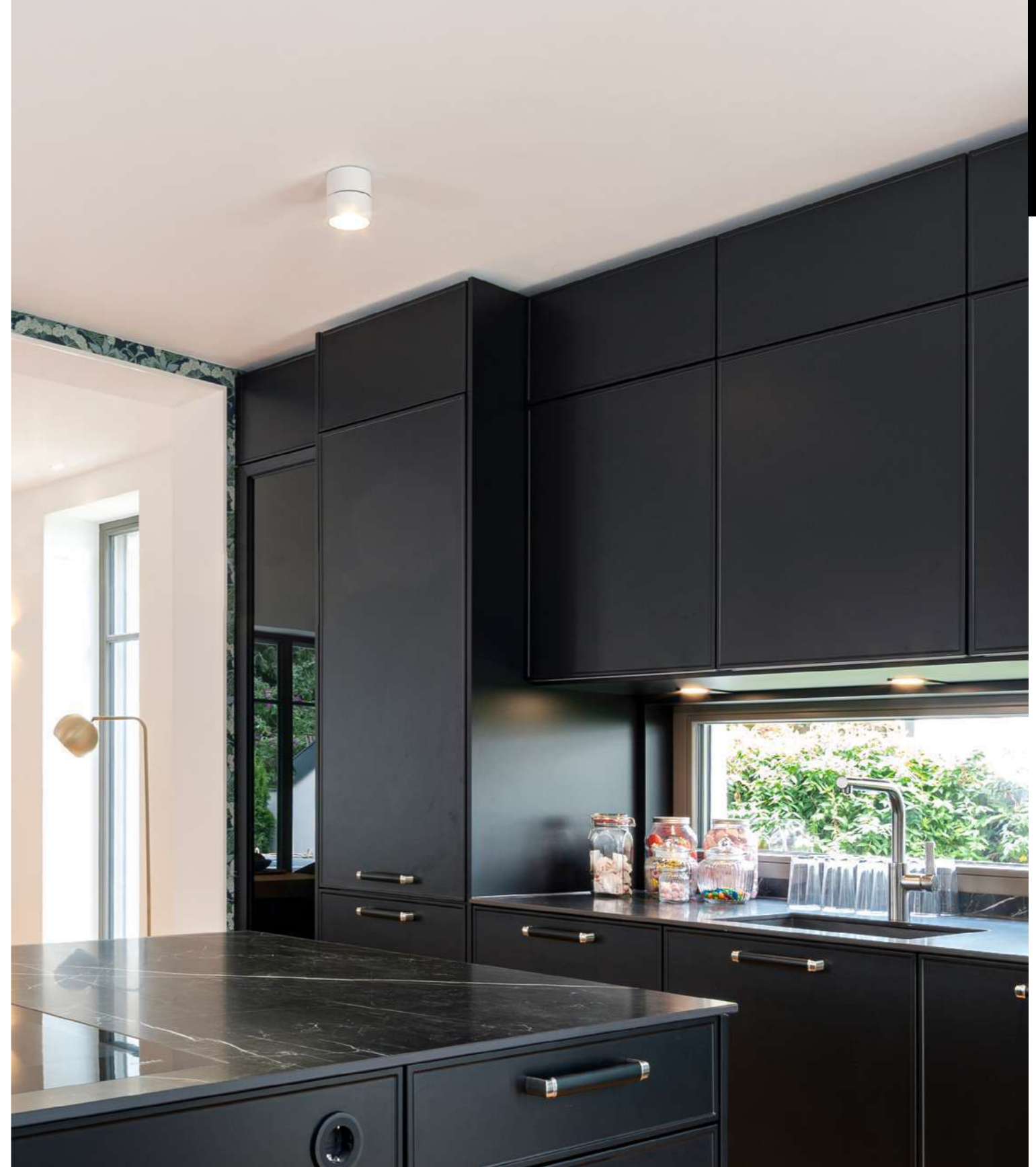

Projekt: Wohnhaus, Deutschland, Foto: Herold Homes Rel EstateDevelopment GmbH, Produkt: MAGIS SINGLE





**MISSOR I**

INFORMATION	LEISTUNG	LUMEN	CRI>	KELVIN	L x B x H	FARBE	REFL.	ART.NR.
Aufbaustrahler, Aluminiumdruckguss, Feinstruktur matt pulverbeschichtet, Dekorring aus Kunststoff schwarz, Strahlerkopf 90° schwenk- und 355° drehbar, 33° Ausstrahlwinkel, Wand- oder Deckenmontage, inkl. Konverter	SYS 12W	660	90	3000	175 x 60 x 148	weiß	33°	276-06290560
	SYS 12W	660	90	3000	175 x 60 x 148	schwarz	33°	276-0629060



**MISSOR II**

INFORMATION	LEISTUNG	LUMEN	CRI>	KELVIN	L x B x H	FARBE	REFL.	ART.NR.
Aufbaustrahler, 2 flammig, Aluminiumdruckguss, Feinstruktur matt pulverbeschichtet, Dekorring aus Kunststoff schwarz, Strahlerkopf 90° schwenk- und 355° drehbar, 33° Ausstrahlwinkel, Wand- oder Deckenmontage, inkl. Konverter	SYS 21W	2x 670	90	3000	336 x 60 x 148	weiß	33°	276-07290560
	SYS 21W	2x 670	90	3000	336 x 60 x 148	schwarz	33°	276-0729060



MISSOR DEKORRING	INFORMATION	Ø	FARBE	ART.NR.
	Ring aus Kunststoff, gold oder weiß, für Missor I, Missor II, werkzeuglos wechselbar. (separat ordern)	60	gold	276-7000
		60	weiß	276-7001

MISSOR WABENRASTER	INFORMATION	Ø	FARBE	ART.NR.
	Wabenraster aus Metall, für Missor I und Missor II, werkzeuglos montierbar. (separat ordern)	60	schwarz	276-1002

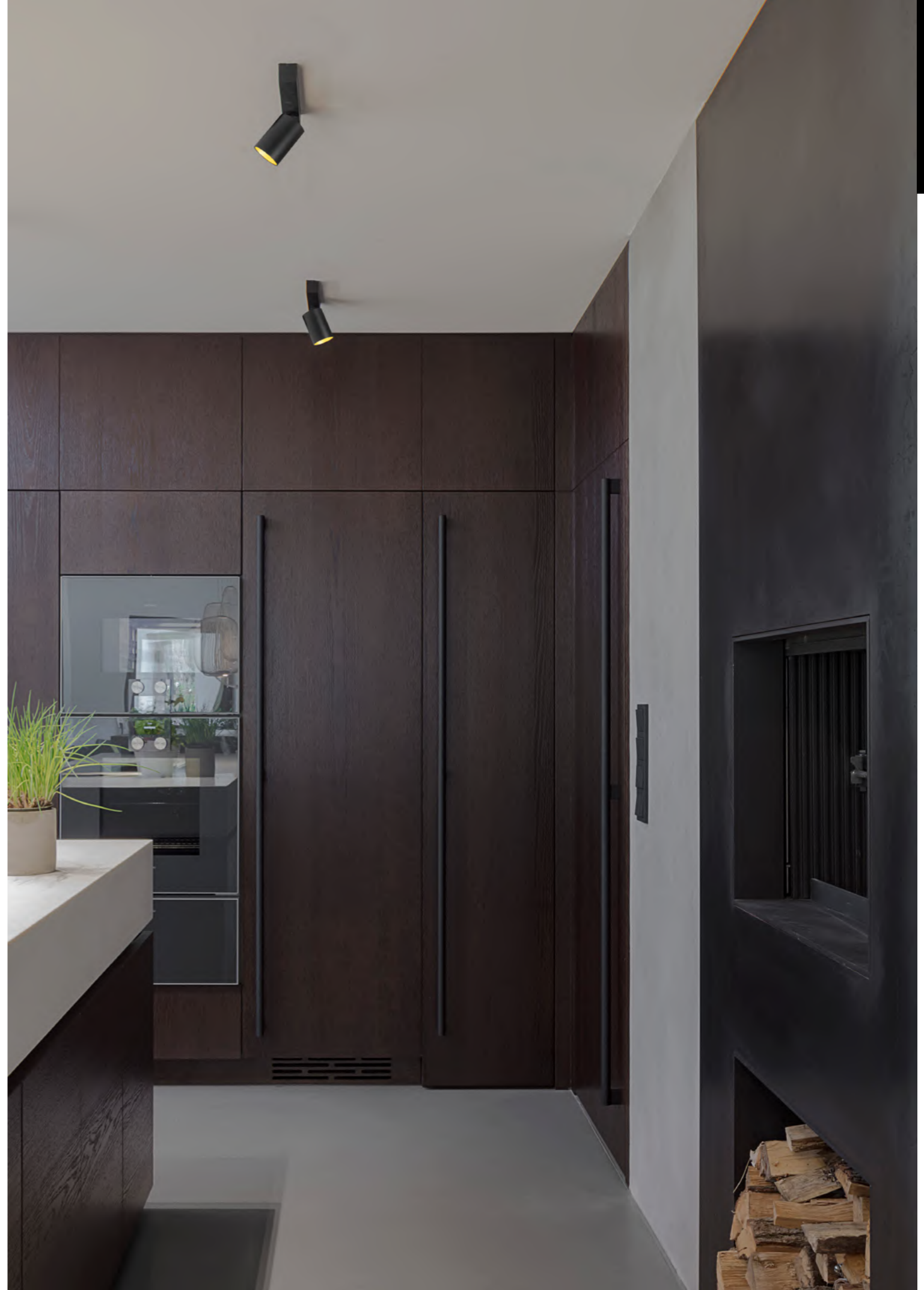

Projekt: Wohnhaus, Österreich, Planung und Umsetzung: Mayr & Glatz GmbH, Foto: Gabriel Büchelmeier, Produkt: MISSOR II

**NOVEL**

INFORMATION	LEISTUNG	LUMEN	CRI>	KELVIN	L x B x T	FARBE	ART.NR.
Wandleuchte, Aluminium lackiert oder pulverbeschichtet, direkt/indirekt breitstrahlend, inkl. Konverter	SYS 8W	359	90	2700	100 x 100 x 100	weiß	472-3927050
	SYS 8W	132	90	2700	100 x 100 x 100	schwarz	472-3927060
	SYS 8W	189	90	2700	100 x 100 x 100	schwarz / gold	472-39270630
	SYS 8W	263	90	2700	100 x 100 x 100	aluminium gebürstet	472-39270140
	SYS 8W	399	90	3000	100 x 100 x 100	weiß	472-3929050
	SYS 8W	147	90	3000	100 x 100 x 100	schwarz	472-3929060
	SYS 8W	210	90	3000	100 x 100 x 100	schwarz / gold	472-39290630
	SYS 8W	292	90	3000	100 x 100 x 100	aluminium gebürstet	472-39290140

**ALICA**

INFORMATION	LEISTUNG	LUMEN	CRI>	KELVIN	L x B x T	FARBE	ART.NR.
Wandleuchte, Aluminium, pulverbeschichtet oder lackiert, direkt/indirekt breitstrahlend, inkl. Konverter	SYS 7W	400	90	2700	200 x 100 x 70	weiß	472-0000790002705
	SYS 7W	215	90	2700	200 x 100 x 70	schwarz	472-0000790002706
	SYS 7W	307	90	2700	200 x 100 x 70	schwarz / gold	472-0000790002763
	SYS 7W	320	90	2700	200 x 100 x 70	aluminium gebürstet	472-0000790002714
	SYS 7W	420	90	3000	200 x 100 x 70	weiß	472-0000790003005
	SYS 7W	220	90	3000	200 x 100 x 70	schwarz	472-0000790003006
	SYS 7W	320	90	3000	200 x 100 x 70	schwarz / gold	472-0000790003063
	SYS 7W	330	90	3000	200 x 100 x 70	aluminium gebürstet	472-0000790003014

**FORO SHORT W FORO LONG W**

INFORMATION	LEISTUNG	LUMEN	CRI>	KELVIN	B x T x H	FARBE	ART.NR.
LED Aufbauleuchte aus Aluminium, matt Feinstruktur pulverbeschichtet, direkt/indirekt breitstrahlend, inkl. Konverter	SYS 4W	260	90	2700	70 x 75 x 60	silber	341-40003440
	SYS 4W	260	90	2700	70 x 75 x 60	weiß	341-40003550
	SYS 4W	260	90	3000	70 x 75 x 60	silber	341-40009440
	SYS 4W	260	90	3000	70 x 75 x 60	weiß	341-40009550
	SYS 11W	934	90	2700	300 x 100 x 70	silber	341-40013440
	SYS 11W	934	90	2700	300 x 100 x 70	weiß	341-40013550
	SYS 11W	951	90	3000	300 x 100 x 70	silber	341-40019440
	SYS 11W	951	90	3000	300 x 100 x 70	weiß	341-40019550

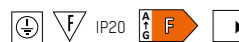
**TAKE 69**

INFORMATION	LM	FASSUNG	V AC	W	L x B x T	FARBE	ART.NR.
Wandleuchte, Aluminium lackiert oder pulverbeschichtet, direkt/indirekt strahlend	RETROFIT	G9	230	max. 7	100 x 100 x 100	weiß	472-291009w
	RETROFIT	G9	230	max. 7	100 x 100 x 100	schwarz	472-291009b
	RETROFIT	G9	230	max. 7	100 x 100 x 100	aluminium gebürstet	472-291009a



Projekt: Wohnhaus, Österreich, Foto: Molto Luce, Produkt: NOVEL

**BO SINGLE****INFORMATION**

Wandleuchte, Aluminiumdruckguss, Feinstruktur matt pulverbeschichtet, direkt/indirekt strahlend, Leuchtenkopf 345° drehbar, inkl. Konverter

LEISTUNG	LUMEN	CRI>	KELVIN	L x B x T	FARBE	ART.NR.
SYS 6W	285	90	2700	135 x 30 x 135	weiß	472-0827050
SYS 6W	175	90	2700	135 x 30 x 135	schwarz	472-0827060

**BO DOUBLE****INFORMATION**

Wandleuchte, 2 flammig, Aluminiumdruckguss, Feinstruktur matt pulverbeschichtet, direkt/indirekt strahlend, Leuchtenköpfe 345° drehbar, inkl. Konverter

LEISTUNG	LUMEN	CRI>	KELVIN	L x B x T	FARBE	ART.NR.
SYS 2x 6W	565	90	2700	240 x 30 x 135	weiß	472-0927050
SYS 2x 6W	330	90	2700	240 x 30 x 135	schwarz	472-0927060

**BENTY****INFORMATION**

Wandleuchte, Aluminiumdruckguss, Feinstruktur matt pulverbeschichtet, geschlossener opaler Acryldiffusor, homogene Lichtverteilung, inkl. Konverter

LEISTUNG	LUMEN	CRI>	KELVIN	L x B x T	FARBE	ART.NR.
SYS 6W	409	90	3000	150 x 145 x 75	weiß	472-291007w

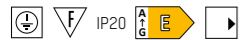
**ALEA G9****INFORMATION**

Wandleuchte, Glas satiniert, 360° drehbar, Socket aus lackiertem Metall

LM	FASSUNG	V AC	W	L x H x T	FARBE	ART.NR.
RETROFIT	G9	230	max. 9	100 x 100 x 105	weiß matt	68-428257

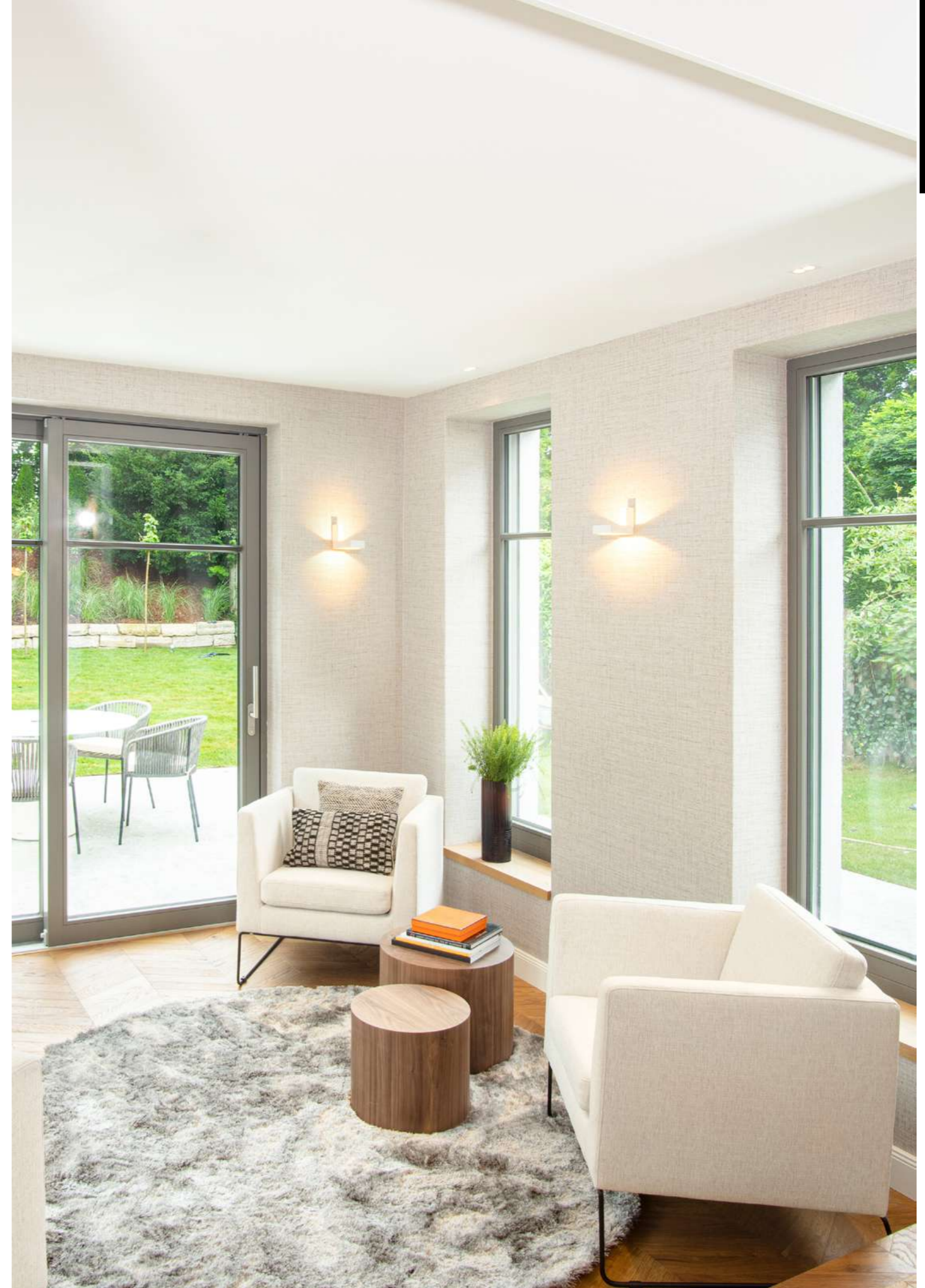

Projekt: Wohnhaus, Deutschland, Foto: Herold Homes Rel EstateDevelopment GmbH, Produkt: BO SINGLE



**ZHOOM W**

**INFORMATION**

Flexible LED Leseleuchte Aluminium, Kopf & Wandmontage Alu natur, weiß oder schwarz, Flexarm schwarz, Lichtkegel stufenlos am Kopf fokussierbar 10° - 60°, Ein/Aus Schalter schwarz an der Leuchte, inkl. Konverter, Kopf: DM 20, L60, Baldachin: DM 63, H37

LEISTUNG	LUMEN	CRI>	KELVIN	L	FARBE	ART.NR.
SYS 2W	153	90	2700	max. 300	weiß	56-185034ng1
SYS 2W	153	90	2700	max. 300	aluminium natur	56-185035ng1
SYS 2W	153	90	2700	max. 300	schwarz	56-185036ng1
SYS 2W	153	90	3000	max. 300	weiß	56-185033ng1
SYS 2W	153	90	3000	max. 300	aluminium natur	56-185030ng1
SYS 2W	153	90	3000	max. 300	schwarz	56-185032ng1

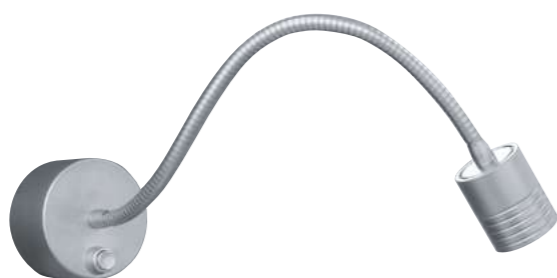

**MOTUS LONG W**

**INFORMATION**

Wandleuchte aus Aluminium, perlchrom galvanisiert oder schwarz, runder Leuchtenkopf, hochwertige Glaslinse 60° klar, flexiblem Arm, Ein/Aus-Schalter an der Leuchte, inkl. Konverter, Kopf: Ø 34, L 40 Baldachin: Ø 63, H 44

LEISTUNG	LUMEN	CRI>	KELVIN	L	FARBE	REF.	ART.NR.
SYS 2W	162	90	3000	max. 380	perlchrom	60°	56-53312ng2
SYS 2W	162	90	3000	max. 380	schwarz	60°	56-53313ng2



**MOTUS SHORT W**

**INFORMATION**

Wandleuchte aus Aluminium, schwarz lackiert, chrom oder perlchrom galvanisiert, runder Leuchtenkopf, hochwertige Glaslinse 60° klar, mit Kugelgelenk, 120° dreh- / 90° schwenkbar, Ein/Aus-Schalter an der Leuchte, inkl. Konverter, Kopf: Ø 34, L 40 Baldachin: Ø 63, H 44

LEISTUNG	LUMEN	CRI>	KELVIN	L	FARBE	REF.	ART.NR.
SYS 2W	162	90	3000	max. 100	perlchrom	60°	56-7301ng2
SYS 2W	162	90	3000	max. 100	schwarz	60°	56-7302ng2

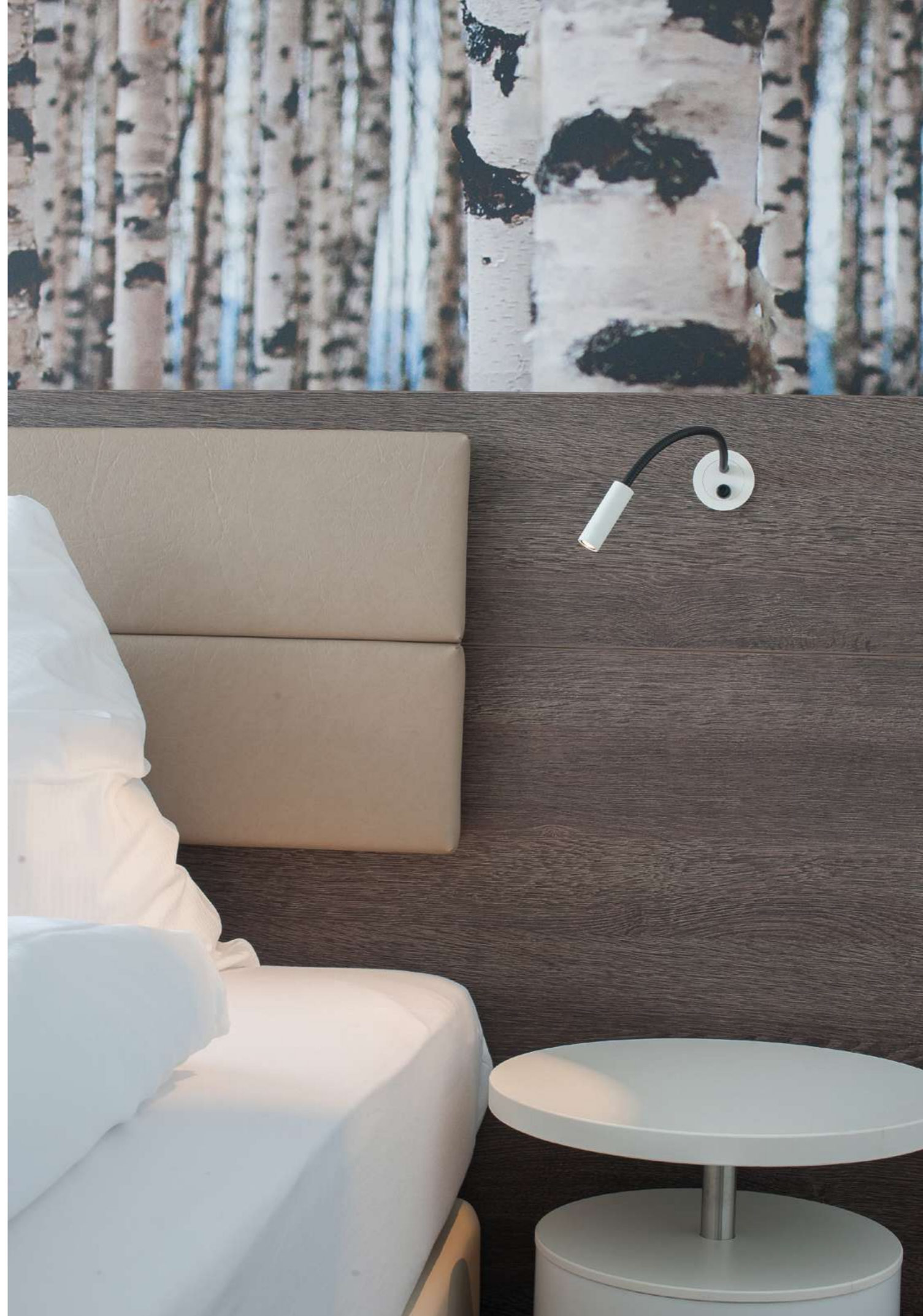

Projekt: Hotel Eco Suite, Salzburg, Österreich, Foto: Molto Luce, Produkt: ZHOOM LONG SD



**NIANO**

**INFORMATION**

Wandleuchte mit flexiblem Arm, Aluminium, matt Feinstruktur pulverbeschichtet, inkl. Konverter, Kopf: DM 28, L65

LEISTUNG	LUMEN	CRI>	KELVIN	Ø x H	L	FARBE	REFL.	ART.NR.
SYS 2W	120	80	2700	84 x 30	500	weiß	20°	8-017050
SYS 2W	120	80	3000	84 x 30	500	weiß	20°	8-019050
SYS 2W	120	80	2700	84 x 30	500	schwarz	20°	8-017060
SYS 2W	120	80	3000	84 x 30	500	schwarz	20°	8-019060



**AROK W**

**INFORMATION**

Wandleuchte aus Aluminium, runder Leuchtenkopf, hochwertige Glaslinse 20° klar, flexiblem Arm, Sensordimmer an der Leuchte, inkl. Konverter Kopf: DM 20, L90

LEISTUNG	LUMEN	CRI>	KELVIN	L x B x H	L	FARBE	REFL.	ART.NR.
SYS 3W	160	90	2700	35 x 35 x 180	490	terra	20°	472-4000320s
SYS 3W	160	90	2700	35 x 35 x 180	490	weiß	20°	472-4000350s
SYS 3W	160	90	2700	35 x 35 x 180	490	schwarz	20°	472-4000360s
SYS 3W	160	90	3000	35 x 35 x 180	490	terra	20°	472-4000920s
SYS 3W	160	90	3000	35 x 35 x 180	490	weiß	20°	472-4000950s
SYS 3W	160	90	3000	35 x 35 x 180	490	schwarz	20°	472-4000960s

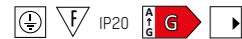

**CLARUS**

**INFORMATION**

Wandleuchte, Aluminiumdruckguss, pulverbeschichtet, direkt/indirekt strahlend, Leuchtenkopf 350° drehbar, inkl. Konverter  
Funktionsweise: Erste Betätigung des Schalters: einschalten Grundlicht; zweite Betätigung des Schalters: einschalten Leselicht, ausschalten Grundlicht; dritte Betätigung des Schalters: aus, Grundlicht & Leselicht können nicht gemeinsam leuchten.

LEISTUNG	LUMEN	CRI>	KELVIN	Ø x T	FARBE	REFL.	ART.NR.
SYS 11W	400	90	2700	120 x 82	weiß	40°	276-0151090402705tr
SYS 11W	365	90	2700	120 x 82	schwarz	40°	276-0151090402706tr
SYS 11W	365	90	2700	120 x 82	schwarz / gold	40°	276-0151090402763tr





### FUSO E27

#### INFORMATION

Wandleuchte, mundgeblasenem  
Mattglas weiß, Metallteile ver-  
chromt, Schutzgitter separat ordern

LM	FASSUNG	V AC	W	B x H x T	FARBE	ART.NR.
RETROFIT	E27	230	max. 13	170 x 300 x 90	opal	68-402157
RETROFIT	E27	230	max. 13	200 x 400 x 100	opal	68-402357



### FUSO SCHUTZGITTER

#### INFORMATION

Passend für Wandleuchte FUSO KLEIN  
Passend für Wandleuchte FUSO GROSS

#### ART.NR.

68-0009p  
68-0009g



Bildretusche, Foto: Shutterstock, Produkt: FUSO LED



### SERIE 44 SHORT SD / SERIE 44 LONG SD

#### INFORMATION

Spiegelleuchte mit zylindrischer Abdeckung, Diffusor aus satiniertem Polycarbonat, Trägerprofil und Enddeckel verchromt. Einspeisung mittig an der Leuchten-Rückseite.

LEISTUNG	LUMEN	CRI>	KELVIN	L x H x T	FARBE	ART.NR.
SYS 20W	1220	80	2700	528 x 93 x 55	chrom/weiß opal	120-40079100
SYS 36W	1740	80	2700	828 x 93 x 55	chrom/weiß opal	120-40089100



### MATAR

#### INFORMATION

Spiegelleuchte, opale Polycarbonatabdeckung, Sockel aus Aluminium in weiß oder schwarz, Schirmbefestigung mittels Klappfedern, Einspeisung an der Seite bzw. mittig an der Leuchten-Rückseite möglich

LEISTUNG	LUMEN	CRI>	KELVIN	L x B x H	FARBE ABDECKUNG	FARBE SOCKEL	ART.NR.
SYS 13W	1400	80	3000	600 x 60 x 46	weiß	weiß	789-71032
SYS 13W	1470	80	4000	600 x 60 x 46	weiß	weiß	789-71532
SYS 19W	2090	80	3000	900 x 60 x 46	weiß	weiß	789-71040
SYS 19W	2200	80	4000	900 x 60 x 46	weiß	weiß	789-71540
SYS 13W	1400	80	4000	600 x 60 x 46	weiß	schwarz	789-71036
SYS 13W	1470	80	4000	600 x 60 x 46	weiß	schwarz	789-71536
SYS 19W	2090	80	3000	900 x 60 x 46	weiß	schwarz	789-71044
SYS 19W	2200	80	4000	900 x 60 x 46	weiß	schwarz	789-71544

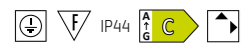

Bildretusche, Foto: istockphoto, Produkt: MATAR





**FOKUS**



INFORMATION	LM	FASSUNG	V AC	W	Ø x H	FARBE	ART.NR.
Aufbauleuchte, Glas satiniert, Sockel aus lackiertem Metall	RETROFIT	G9	230	max. 7	110 x 140	opal	68-518657



**ALKOR 2 E27**



INFORMATION	LM	FASSUNG	V AC	W	Ø x H	Ø SOCKEL	FARBE	ART.NR.
Aufbauleuchte, Sockel aus Stahlblech, pulverbeschichtet weiß, mundeblasenes Dreischichtglas TRIPLEX opal matt, Schirmbefestigung mittels Klappfedern	RETROFIT	E27	230	max. 7	104 x 156	120	weiß	789-52162



**APUS E27**



INFORMATION	LM	FASSUNG	V AC	W	L x B x H	Ø SOCKEL	FARBE	ART.NR.
Aufbauleuchte, Sockel aus Stahlblech, pulverbeschichtet weiß, mundeblasenes Dreischichtglas TRIPLEX opal matt, Schirmbefestigung mittels Klappfedern	RETROFIT	E27	230	max. 7	140 x 140 x 156	120	weiß	789-52160
	RETROFIT	E27	230	max. 7	184 x 184 x 200	160	weiß	789-52161
	RETROFIT	E27	230	max. 7	230 x 230 x 250	200	weiß	789-71277



ABDECKUNG INFO	ABBILDUNG	L x B x H	FARBE	ART.NR.
dekorative Abdeckung aus Metall - nur passend für Apus 184 x 184mm		235 x 184 x 184	schwarz	789-33510



Produkt: FOKUS



## LINA E27

INFORMATION	LM	FASSUNG	V AC	W	L x B x H	SOCKEL Ø	FARBE	ART.NR.
Wand-/ Deckenleuchte, Trägerplatte Stahlblech weiß, mundgeblasenes Dreischicht- glas TRIPLEX opal matt, Schirmbefestigung mittels Klappfedern	RETROFIT	E27	230	max. 9	200 x 200 x 105	172	weiß	789-41252
	RETROFIT	E27	230	max. 14	260 x 260 x 110	225	weiß	789-41262
	2x RETROFIT	E27	230	max. 9	260 x 260 x 110	230	weiß	789-41270
	2x RETROFIT	E27	230	max. 14	320 x 320 x 115	275	weiß	789-41307
	2x RETROFIT	E27	230	max. 11	380 x 380 x 120	325	weiß	789-42310
	3x RETROFIT	E27	230	max. 11	440 x 440 x 125	375	weiß	789-43070



## TILIA E27

INFORMATION	LM	BWM	FASSUNG	V AC	W	L x B x H	SOCKEL L x B	FARBE	ART.NR.
Wand-/ Deckenleuchte, Trägerplatte Stahlblech, weiß lackiert, opale Polycarbonat- abdeckung, Schirmbefesti- gung mittels Klappfedern <b>BWM:</b> mit Bewegungsmelder 1 - 5m	RETROFIT	---	E27	230	max. 8	220 x 220 x 70	200 x 200	weiß	789-52120
	2x RETROFIT	---	E27	230	max. 9	300 x 300 x 70	270 x 270	weiß	789-56155
	2x RETROFIT	<b>X</b>	E27	230	max. 9	300 x 300 x 70	270 x 270	weiß	789-56159
	2x RETROFIT	---	E27	230	max. 8	360 x 360 x 70	337 x 337	weiß	789-52575
	3x RETROFIT	---	E27	230	max. 9	400 x 400 x 70	375 x 375	weiß	789-56171
	4x RETROFIT	---	E27	230	max. 8	550 x 550 x 70	525 x 525	weiß	789-52121



Bildretusche, Foto: Shutterstock, Produkt: LINA



**MUSO SQUARE**

INFORMATION	LEISTUNG	BWM	LUMEN	CRI>	KELVIN	L x B x H	FARBE	ART.NR.
Quadratische LED Aufbauleuchte in 3 Größen, Material Polycarbonat weiß, Abdeckung Polycarbonat opal matt, öffnen der Leuchte für den Anschluss nicht notwendig, Einfachste Deckenmontage, inkl. Konverter <b>BWM:</b> mit Dip-Switch zu Einstellung von Stand-By Zeit / Tageslichtsensor / Leuchtdauer und Bewegungsradius	SYS 18W	---	1750	80	3000	280 x 280 x 48	weiß	501-q2819150
	SYS 24W	---	2270	80	3000	330 x 330 x 48	weiß	501-q3319150
	SYS 24W	<b>X</b>	2270	80	3000	330 x 330 x 53	weiß	501-1q331915h
	SYS 36W	---	3200	80	3000	400 x 400 x 48	weiß	501-q4019150
	SYS 18W	---	1750	80	4000	280 x 280 x 48	weiß	501-q2814150
	SYS 24W	---	2270	80	4000	330 x 330 x 48	weiß	501-q3314150
	SYS 24W	<b>X</b>	2270	80	4000	330 x 330 x 53	weiß	501-0q331415h
	SYS 36W	---	3200	80	4000	400 x 400 x 48	weiß	501-q4014150



MUSO SQUARE 280/330/400

Bei den Größen 280 & 330 erfolgt die Montage der Leuchte an der Grundplatte mittels Montageclip. Bei der Größe 400 ist die Montage verschraubt. Eine Aussparung für seitliche Kabeleinführung ist vorhanden.

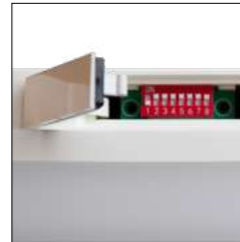

**BWM:** Der Bewegungsmelder ist seitlich hinter einer Abdeckung einstellbar.



**MUSO ROUND**

INFORMATION	LEISTUNG	BWM	NOTLICHT	LUMEN	CRI>	KELVIN	Ø x H	FARBE	ART.NR.
Runde LED Aufbauleuchte in 3 Größen, Material Polycarbonat weiß, Abdeckung Polycarbonat opal matt, öffnen der Leuchte für den Anschluss nicht notwendig, Einfachste Deckenmontage, inkl. Konverter; <b>BWM:</b> Mit Dip-Switch zu einstellung von Stand-By Zeit / Tageslichtsensor / Leuchtdauer und Bewegungsradius <b>NOTLICHT:</b> 2W, Akkulaufzeit: ca. 3 Std.	SYS 18W	---	---	1750	80	3000	280 x 48	weiß	501-r2819150
	SYS 18W	---	<b>X</b>	1750	80	3000	280 x 48	weiß	501-r281915e
	SYS 24W	---	---	2270	80	3000	330 x 48	weiß	501-r3319150
	SYS 24W	<b>X</b>	---	2270	80	3000	330 x 53	weiß	501-1r331915h
	SYS 36W	---	---	3200	80	3000	400 x 48	weiß	501-r4019150
	SYS 18W	---	---	1750	80	4000	280 x 48	weiß	501-r2814150
	SYS 24W	---	---	2270	80	4000	330 x 48	weiß	501-r3314150
	SYS 24W	<b>X</b>	---	2270	80	4000	330 x 53	weiß	501-0r331415h
	SYS 36W	---	---	3200	80	4000	400 x 48	weiß	501-r4014150

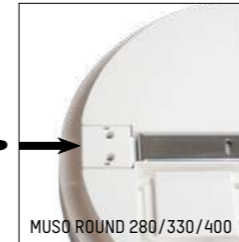
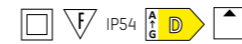

MUSO ROUND 280/330/400

Bei allen Größen erfolgt die Montage der Leuchte an der Grundplatte mittels Montageclip. Eine Aussparung für seitliche Kabeleinführung ist vorhanden.

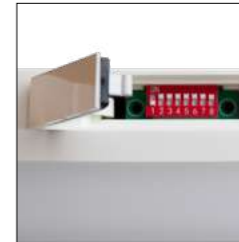

**BWM:** Der Bewegungsmelder ist seitlich hinter einer Abdeckung einstellbar.



Bildretusche, Foto: Shutterstock, Produkt: MUSO SQUARE



Bildretusche, Foto: Shutterstock, Produkt: MUSO SQUARE



## DELIA

## INFORMATION

Wand- / Deckenleuchte, Trägerplatte Stahlblech, weiß lackiert, opale Polycarbonat-Abdeckung oder PMMA-Abdeckung, Schirmbefestigung mittels Klappfedern, inkl. Konverter  
**BWM:** mit Bewegungsmelder 1 - 5m

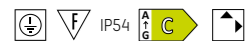

LEISTUNG	BWM	LUMEN	CRI>	KELVIN	Ø x H	SOCKEL Ø	FARBE	ART.NR.
SYS 5W	---	460	80	3000	140 x 65	120	weiß	789-56275
SYS 5W	---	480	80	4000	140 x 65	120	weiß	789-56775
SYS 11W	---	950	80	3000	220 x 70	200	weiß	789-56282
SYS 11W	---	1000	80	3000	220 x 70	200	weiß	789-56782
SYS 15W	---	1480	80	4000	300 x 75	275	weiß	789-56290
SYS 15W	<b>X</b>	1480	80	3000	300 x 75	275	weiß	789-56291
SYS 15W	---	1560	80	4000	300 x 75	275	weiß	789-56790
SYS 20W	---	1920	80	3000	300 x 75	275	weiß	789-53316
SYS 20W	---	2000	80	4000	300 x 75	275	weiß	789-53816
SYS 19W	---	1750	80	3000	360 x 71	342	weiß	789-67200
SYS 19W	---	1830	80	4000	360 x 71	342	weiß	789-67700
SYS 27W	---	2350	80	3000	360 x 71	342	weiß	789-67206
SYS 27W	---	2450	80	4000	360 x 71	342	weiß	789-67706
SYS 29W	---	2580	80	3000	400 x 80	375	weiß	789-56300
SYS 29W	<b>X</b>	2580	80	3000	400 x 80	375	weiß	789-56301
SYS 33W	---	3400	80	3000	400 x 80	375	weiß	789-53337
SYS 36W	---	3550	80	4000	400 x 80	375	weiß	789-53837



## DELIA E27

## INFORMATION

Wand- / Deckenleuchte, Trägerplatte Stahlblech, weiß lackiert, opale Polycarbonat-Abdeckung, Schirmbefestigung mittels Klappfedern,  
**BWM:** mit Bewegungsmelder 1 - 5m  
 Versionen mit Glasabdeckung auf Anfrage



LM	BWM	FASSUNG	V AC	W	Ø x H	SOCKEL Ø	FARBE	ART.NR.
RETROFIT	---	E27	230	max. 8	220 x 70	200	weiß	789-52112
RETROFIT	---	E27	230	max. 8	300 x 75	275	weiß	789-56075
RETROFIT	<b>X</b>	E27	230	max. 8	300 x 75	275	weiß	789-56079
2x RETROFIT	---	E27	230	max. 8	360 x 71	342	weiß	789-52560
2x RETROFIT	---	E27	230	max. 8	400 x 80	375	weiß	789-56110
2x RETROFIT	<b>X</b>	E27	230	max. 8	400 x 80	375	weiß	789-56116
3x RETROFIT	---	E27	230	max. 8	500 x 85	465	weiß	789-56130
3x RETROFIT	<b>X</b>	E27	230	max. 8	500 x 85	465	weiß	789-56137



Bildretusche, Foto: Shutterstock, Produkt: DELIA LED



## ELSA E27

## INFORMATION

Wand- / Deckenleuchte, Trägerplatte Stahlblech, weiß lackiert, Abdeckung, mundgeblasenes Dreischichtglas Triplex-Opal mit mattierter Oberfläche, Bajonettverschluss



LM	FASSUNG	V AC	W	Ø x H	SOCKEL Ø	FARBE	ART.NR.
RETROFIT	E27	230	max. 9	250 x 84	205	weiß	789-44705
2x RETROFIT	E27	230	max. 9	300 x 86	250	weiß	789-44741
2x RETROFIT	E27	230	max. 11	420 x 90	345	weiß	789-44900

**AURA E27****INFORMATION**

Wand-/ Deckenleuchte, Trägerplatte  
Stahlblech, weiß lackiert, mundgeblasenes Dreischichtglas TRIPLEX opal matt, Halterung mittels Bajonettverschluss

LM	FASSUNG	V AC	W	Ø x H	Ø SOCKEL	FARBE	ART.NR.
RETROFIT	E27	230	max. 9	200 x 105	170	weiß	789-42702
RETROFIT	E27	230	max. 11	250 x 110	205	weiß	789-42703
2x RETROFIT	E27	230	max. 9	300 x 115	250	weiß	789-42709
2x RETROFIT	E27	230	max. 11	360 x 125	290	weiß	789-42742
2x RETROFIT	E27	230	max. 11	420 x 125	345	weiß	789-42775

**TITAN E27****INFORMATION**

Wand-/ Deckenleuchte, Trägerplatte  
Stahlblech, weiß lackiert, Halterung mittels Bajonettverschluss

LM	FASSUNG	V AC	W	Ø x H	Ø SOCKEL	FARBE	ART.NR.
RETROFIT	E27	230	max. 6	220 x 100	200	weiß	789-56050
RETROFIT	E27	230	max. 6	300 x 105	275	weiß	789-56000
2x RETROFIT	E27	230	max. 6	400 x 115	375	weiß	789-56012
3x RETROFIT	E27	230	max. 6	500 x 130	465	weiß	789-56024
4x RETROFIT	E27	230	max. 6	650 x 150	625	weiß	789-56056
6x RETROFIT	E27	230	max. 6	900 x 200	875	weiß	789-56061

**BRSB****INFORMATION**

Wand-/ Deckenleuchte rund, Stahlblech  
weiß lackiert, mit opalem Diffuser aus PMMA, inkl. LED Konverter

LEISTUNG	LUMEN	CRI>	KELVIN	Ø x H	FARBE	ART.NR.
SYS 14W	1400	80	3000	285 x 90	weiß	757-l2004
SYS 14W	1400	80	4000	285 x 90	weiß	757-l2005
SYS 28W	2700	80	3000	375 x 110	weiß	757-l2006
SYS 28W	2700	80	4000	375 x 110	weiß	757-l2007
SYS 34W	3600	80	3000	480 x 150	weiß	757-l2008
SYS 34W	3600	80	4000	480 x 150	weiß	757-l2009

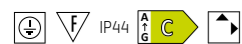

Fotoretusche, Foto: shutterstock, Produkt: TITAN



**DESCO M**

**INFORMATION**

Deckenaufbauleuchte, Aluminium, pulverbeschichtet, rund, direkt strahlend, opaler Diffuser, Lichtfarbe einstellbar mittels Schalter auf LED-Board, inkl. Konverter



LEISTUNG	LUMEN	CRI>	KELVIN	Ø x H	FARBE	ART.NR.
SYS 15W	1005/983/972	90	2700/3000/4000	240 x 50	weiß	341-r2419150
SYS 15W	1005/983/972	90	2700/3000/4000	240 x 50	schwarz	341-r2419160



**DESCO L**

**INFORMATION**

Deckenaufbauleuchte, Aluminium, pulverbeschichtet, rund, direkt strahlend, opaler Diffuser, Lichtfarbe einstellbar mittels Schalter auf LED-Board, inkl. Konverter



LEISTUNG	LUMEN	CRI>	KELVIN	Ø x H	FARBE	ART.NR.
SYS 21W	1526/1567/1554	90	2700/3000/4000	330 x 74	weiß	341-R3319150
SYS 21W	1526/1567/1554	90	2700/3000/4000	330 x 74	schwarz	341-R3319160





**GIL0 PD**

**INFORMATION**

Hängeleuchte, Aluminiumdruckguss, matt Feinstruktur pulverbeschichtet, Diffusor aus opalem Acryl, inkl. Konverter, inkl. Deckenbaldachin und 2000 mm Abhängung

LEISTUNG	LUMEN	CRI>	KELVIN	Ø x H	FARBE	ART.NR.
SYS 7W	338	90	3000	80 x 90	weiß	472-2429150
SYS 7W	338	90	3000	80 x 90	schwarz	472-2429160



**ISIS E27**

**INFORMATION**

Kugelleuchte, opale PMMA-Abdeckung matt satiniert, Kabelabhängung, Baldachin und Fassung in weiß oder schwarz, auf Anfrage Abhängung mit Stahlseil und Kabel bzw. starrem Pendel aus Aluminium erhältlich

LM	FASSUNG	V AC	W	Ø	FARBE LEUCHE	FARBE ABDECKUNG	ART.NR.
RETROFIT	E27	230	max. 6	300	weiß	weiß	789-63805
RETROFIT	E27	230	max. 6	300	weiß	schwarz	789-63806
RETROFIT	E27	230	max. 6	400	weiß	weiß	789-63810
RETROFIT	E27	230	max. 6	400	weiß	schwarz	789-63811
RETROFIT	E27	230	max. 6	500	weiß	weiß	789-63815
RETROFIT	E27	230	max. 6	500	weiß	schwarz	789-63816



Bildretusche, Foto: iStock, Produkt: ISIS E27



### DIVO SHORT PD / DIVO LONG

#### INFORMATION

Dekorative Hängeleuchte aus Aluminium, pulverbeschichtet, Abhängung max. 1500 mm; Deckenbaldachin inkl. Konverter.

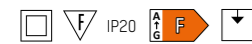

LEISTUNG	LUMEN	CRI>	KELVIN	Ø x H	ART.NR.
SYS 11W	680	90	2700	57 x 300	192-2020200023XXY
SYS 11W	680	90	3000	57 x 300	192-2020200029XXY
SYS 11W	680	90	2700	57 x 600	192-2020300023XXY
SYS 11W	680	90	3000	57 x 600	192-2020300029XXY

#### ARTIKELNUMMER ERGÄNZEN

XX = FARBE

weiß = 55

schwarz = 56

Y = DIMMBARKEIT

0 = schaltbar

d = DALI dimmbar







# Weitere Aufbauleuchten aus dem Molto Luce Programm

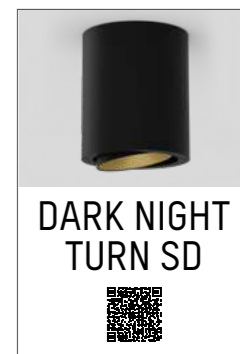

# WANDEINBAU





**WINDOW I**

INFORMATION	LEISTUNG	mA	LUMEN	CRI>	KELVIN	B x H x ET	WA B x H	FARBE	ART.NR.
Wandeinbauleuchte, Aluminium eloxiert, quadratisch, symmetrisch, inkl. Haltefedern für Hohlwandmontage, exkl. Konverter, Betoneinbaugehäuse separat ordern	LED 3W	250	234	80	3000	80 x 80 x 68	69 x 69	aluminium eloxiert	305-6801p
BETONEINBAUGEHÄUSE INFO	ABBILDUNG		B x H x T	ET L x B x H	ART.NR.				
Aus verzinktem Blech, inkl. Einputzrahmen, passend für WINDOW, nicht für Sichtbeton geeignet			142 x 138 x 38	140 x 125 x 50	305-5058				

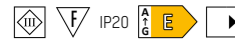

**WINDOW II**

INFORMATION	LEISTUNG	mA	LUMEN	CRI>	KELVIN	B x H x ET	WA B x H	FARBE	ART.NR.
Wandeinbauleuchte, Aluminium eloxiert, quadratisch, asymmetrisch, inkl. Haltefedern für Hohlwandmontage, exkl. Konverter, Betoneinbaugehäuse separat ordern	LED 3W	250	167	80	3000	80 x 80 x 68	69 x 69	aluminium eloxiert	305-6800p
BETONEINBAUGEHÄUSE INFO	ABBILDUNG		B x H x T	ET L x B x H	ART.NR.				
Aus verzinktem Blech, inkl. Einputzrahmen, passend für WINDOW II, nicht für Sichtbeton geeignet			142 x 138 x 38	140 x 125 x 50	305-5058				



KONVERTER WINDOW	INFORMATION	WATT	mA	V DC	V AC	L x B x H	FARBE	ART.NR.
	nicht dimmbar	6W	250	23	230	42 x 40 x 22	schwarz	24-122812



**PAN**

INFORMATION	LEISTUNG	mA	LUMEN	CRI>	KELVIN	B x H x ET	WA B x H	FARBE	ART.NR.
Wandeinbauleuchte aus Aluminium, quadratisch, pulverbeschichtet, asymmetrisch, Diffusor opal, Lichtaustritt direkt, inkl. Haltefedern für Hohlraummontage, exkl. Konverter, Betoneinbaugehäuse separat ordern	LED 3W	250	155	80	3000	80 x 80 x 62	69 x 69	weiß	305-0130380003005
	LED 3W	250	155	80	3000	80 x 80 x 62	69 x 69	silber	305-0130380003004
	LED 3W	250	155	80	3000	80 x 80 x 62	69 x 69	schwarz	305-0130380003006
BETONEINBAUGEHÄUSE INFO	ABBILDUNG		B x H x T	ET L x B x H	ART.NR.				
Aus verzinktem Blech, inkl. Einputzrahmen, passend für PAN, nicht für Sichtbeton geeignet			142 x 138 x 38	140 x 125 x 50	305-5058				

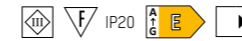

LED KONVERTER	INFORMATION	WATT	mA	V DC	V AC	L x B x H	FARBE	ART.NR.
	nicht dimmbar	6W	250	23	230	42 x 40 x 22	schwarz	24-122812



Projekt: Wohnhaus, Österreich, Foto: Molto Luce, Produkt: PAN



**SPOON QUADRO**

**INFORMATION**  
Wandeinbauleuchte, Aluminium eloxiert oder weiß lackiert, quadratisch, starr, asymmetrisch, inkl. Kühlkörper, exkl. Konverter, Einbaubox oder Betoneinbauhülse separat ordern.

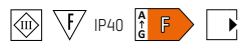

LEISTUNG	mA	LUMEN	CRI>	KELVIN	Ø x ET	DA Ø	FARBE	REFL.	ART.NR.
LED 2W	500	199	80	3000	45 x 67	38	weiß	---	68-635101WW
LED 2W	500	199	80	3000	45 x 67	38	aluminium eloxiert	---	68-635145WW
EINBAUBOX INKL. PUTZRAHMEN INFO					ABBILDUNG	B x H x ET	ART.NR.		
Einbaubox inkl. Putzrahmen für Spoon						123 x 90 x 52 + 8 (Aufkantung)	68-0214		
BETONEINBAUHÜLSE INFO					ABBILDUNG	Ø x ET	ART.NR.		
Wandeinbauhülse, Kunststoff, für Spoon						48 x 80	68-0217		



**SPOON TONDO**

**INFORMATION**  
Wandeinbauleuchte, Aluminium eloxiert oder weiß lackiert, rund, starr, asymmetrisch, inkl. Kühlkörper, exkl. Konverter, Einbaubox oder Betoneinbauhülse separat ordern.



LEISTUNG	mA	LUMEN	CRI>	KELVIN	Ø x ET	DA Ø	FARBE	REFL.	ART.NR.
LED 2W	500	199	80	3000	45 x 67	38	weiß	---	68-635001WW
LED 2W	500	199	80	3000	45 x 67	38	aluminium eloxiert	---	68-635045WW
BODENEINBAUHÜLSE INFO					ABBILDUNG	B x H x ET	ART.NR.		
Einbaubox inkl. Putzrahmen für Spoon						123 x 90 x 52 + 8 (Aufkantung)	68-0214		
BETONEINBAUHÜLSE INFO					ABBILDUNG	Ø x ET	ART.NR.		
Wandeinbauhülse, Kunststoff, für Spoon						48 x 80	68-0217		

KONVERTER SPOON	INFORMATION	WATT	mA	V DC	V AC	L x B x H	FARBE	ART.NR.
	nicht dimmbar	6W	500	11,5	230	60 x 35 x 21,5	weiß	24-122602
	nicht dimmbar	20W	500	40	230	111 x 52 x 22	weiß	24-122201

**MONTAGEANLEITUNG**



**KADO R**

**INFORMATION**  
Einbaustrahler, Aluminium, schwarz lackiert, chrom oder perlchrom galvanisiert, rund, starr, facettierte Linse 12 oder 30°, exkl. Konverter, Zubehör separat ordern



LEISTUNG	mA	LUMEN	CRI>	KELVIN	Ø x ET	DA Ø	REFL.	FARBE	ART.NR.
2W	500	162	90	3000	50 x 30	42	12°	chrom	56-6126ng2
2W	500	162	90	3000	50 x 30	42	12°	perlchrom	56-6026ng2
2W	500	162	90	3000	50 x 30	42	12°	schwarz	56-6226ng2
2W	500	162	90	3000	50 x 30	42	30°	chrom	56-6127ng2
2W	500	162	90	3000	50 x 30	42	30°	perlchrom	56-6027ng2
2W	500	162	90	3000	50 x 30	42	30°	schwarz	56-6227ng2
UNTERPUTZKLEMMDOSE INFO					ABBILDUNG	L x B x H x ET	ART.NR.		
für Kado, DM 42mm, Achtung: nur LED Konverter der Serie 75-MPL passen in die Unterputzklemmdose						100 x 100 x 60 x 52	56-ak7542		

KONVERTER	INFORMATION	WATT	mA	V DC	V AC	L x B x H	FARBE	ART.NR.
	nicht dimmbar	4W	500	54	230	51 x 32 x 18	schwarz	75-mpl5
	nicht dimmbar	20W	500	40	230	111 x 52 x 22	weiß	24-122201



Foto: EgoLuce, Produkt: SPOON TONDO



**MOTUS LONG WR**

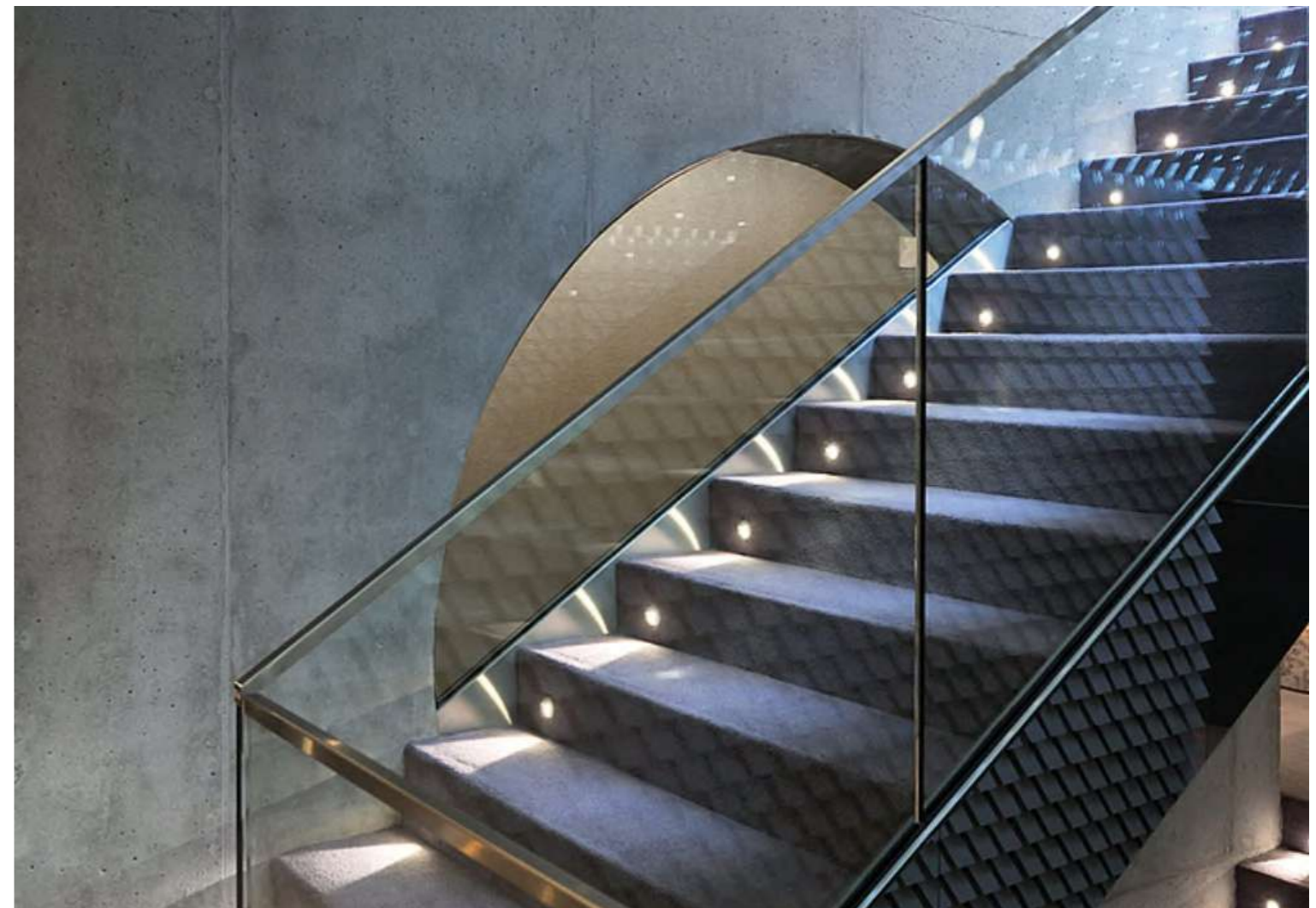

INFORMATION	LEISTUNG	mA	LUMEN	CRI>	KELVIN	L x ET	WA Ø	FARBE	ART.NR.
Halbeinbauleuchte (Leseleuchte) aus Aluminium, schwarz lackiert, perlchrom galvanisiert, runder Leuchtenkopf, hochwertige Glaslinse 60° klar, flexiblem Arm, Ein/Aus-Schalter an der Leuchte, exkl. Konverter, Auf Anfrage auch mit 12° oder 30° Glaslinse erhältlich. Kopf: Ø 34, L 40 Baldachin: Ø 59, H 5	LED 2W	500	162	90	3000	380 x 15	38	perlchrom	<b>56-53012ng2</b>
	LED 2W	500	162	90	3000	380 x 15	38	schwarz	<b>56-53013ng2</b>

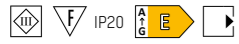

KONVERTER	INFORMATION	WATT	mA	V DC	V AC	L x B x H	FARBE	ART.NR.
	nicht dimmbar	4W	500	9	230	51 x 32 x 19	schwarz	<b>75-mp15</b>



**ZH00M WR**



INFORMATION	LEISTUNG	mA	LUMEN	CRI>	KELVIN	L x ET	WA Ø	FARBE	ART.NR.
Wandeinbauleuchte aus Aluminium, Feinstruktur matt pulverbeschichtet, hochwertige Glaslinse, exkl. Konverter Kopf: Ø 20, L 40 Baldachin: Ø 59, H 6	LED 2W	500	153	90	2700	300 x 15	38	weiß matt	<b>56-185025ng1</b>
	LED 2W	500	153	90	2700	300 x 15	38	schwarz	<b>56-185023ng1</b>
	LED 2W	500	153	90	2700	300 x 15	38	natur	<b>56-185024ng1</b>
	LED 2W	500	153	90	3000	300 x 15	38	weiß matt	<b>56-185029ng1</b>
	LED 2W	500	153	90	3000	300 x 15	38	schwarz	<b>56-185027ng1</b>
	LED 2W	500	153	90	3000	300 x 15	38	natur	<b>56-185026ng1</b>

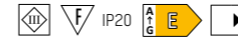

KONVERTER	INFORMATION	WATT	mA	V DC	V AC	L x B x H	FARBE	ART.NR.
	nicht dimmbar	4W	500	9	230	51 x 32 x 18	schwarz	<b>75-mp15</b>



Projekt: Wohnhaus, Österreich, Foto: Molto Luce, Produkt: MOTUS LONG WR

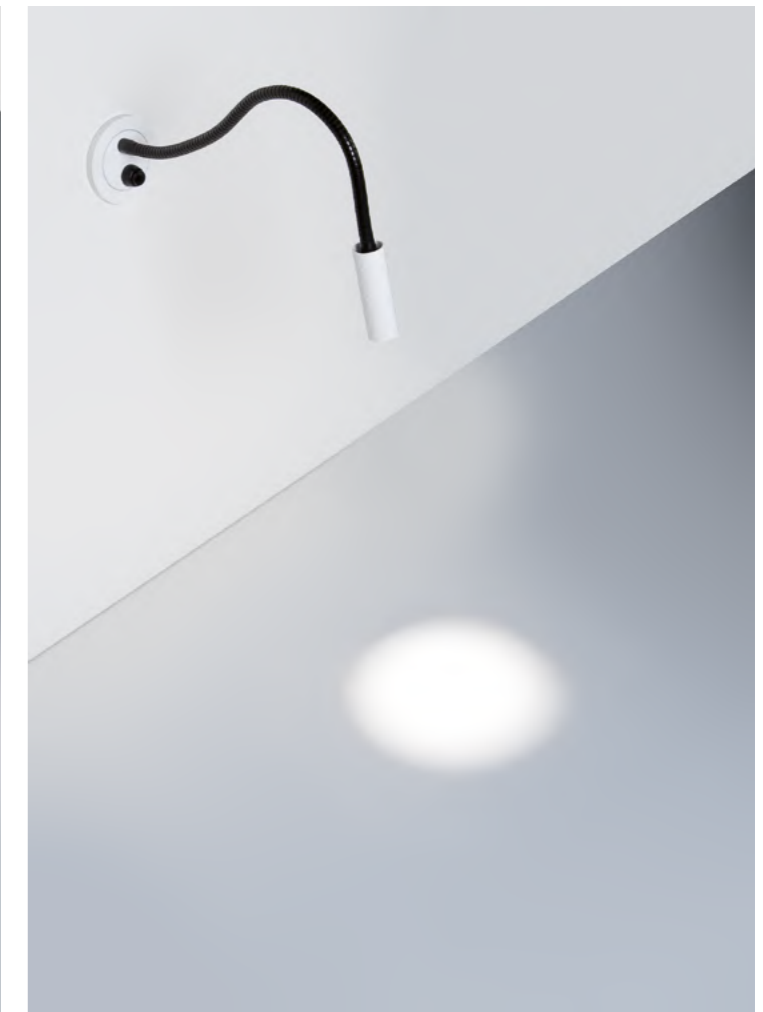

# STRAHLER + STROMSCHIENEN



STRAHLER + STROMSCHIENEN

STRAHLER + STROMSCHIENEN



Produkt: LITIN 2 TRACK

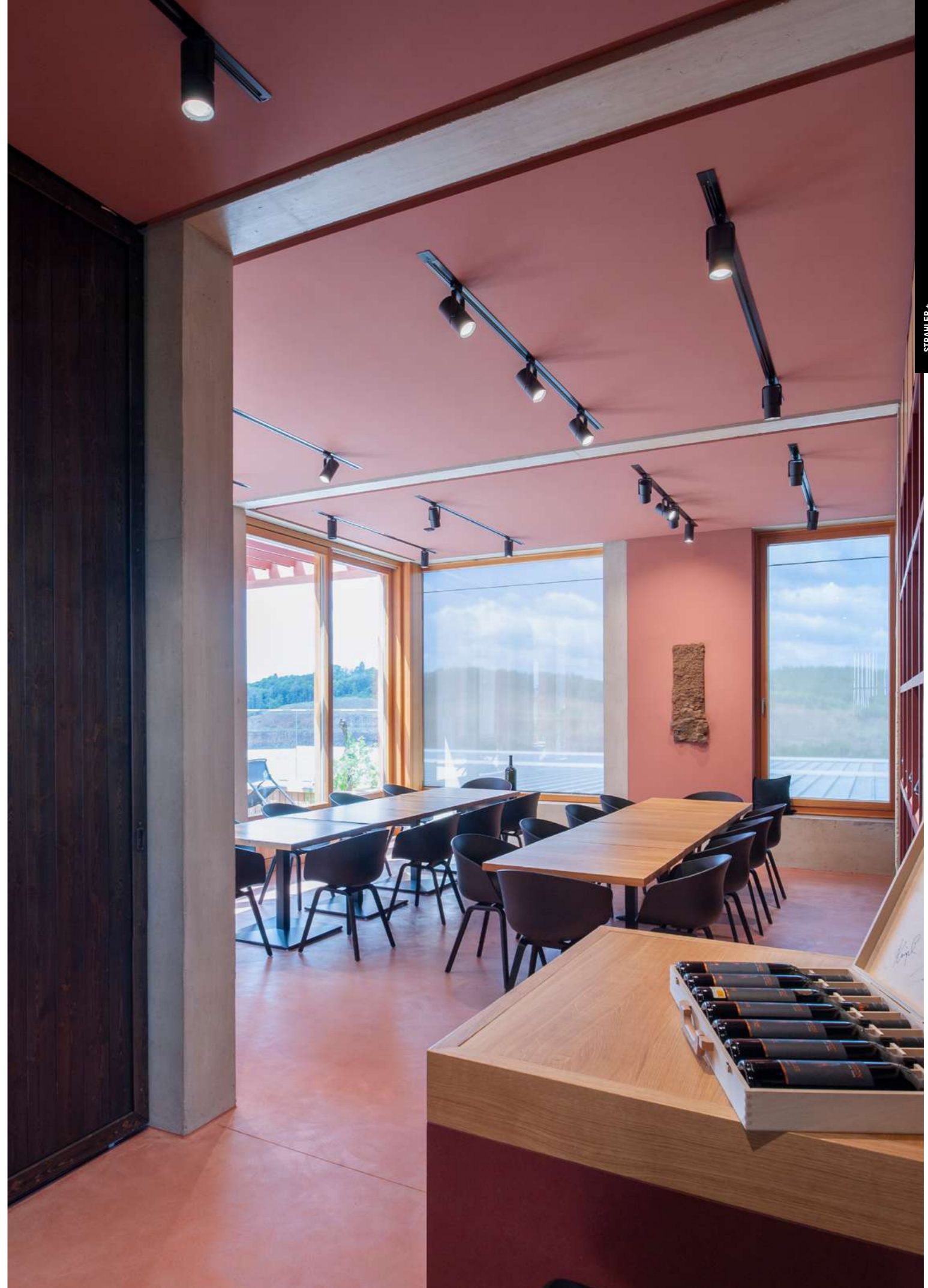

Projekt: Weingut Müller Vinothek, Klösch, Österreich, Foto: Molto Luce, Produkt: 2 GO TRACK



Projekt: Ducati Flagship Store, Ingolstadt, Germany, Photo: Joachim Rauch, Produkt: MOVA M TRACK



Produkt: DASH 2 TRACK





Projekt: INTERSPORT Schneider, Schladming, Österreich, Photo: Joachim Rauch, Produkt: VALO TRACK, 2 GO + TRACK



Projekt: IGLE Bookstore, Amsterdam, Netherlands, Project by Unique Brands, Designer: M+R Interior Architecture, Foto: Studio de Winter, Produkt: SHOPSTAR LEAN TRACK

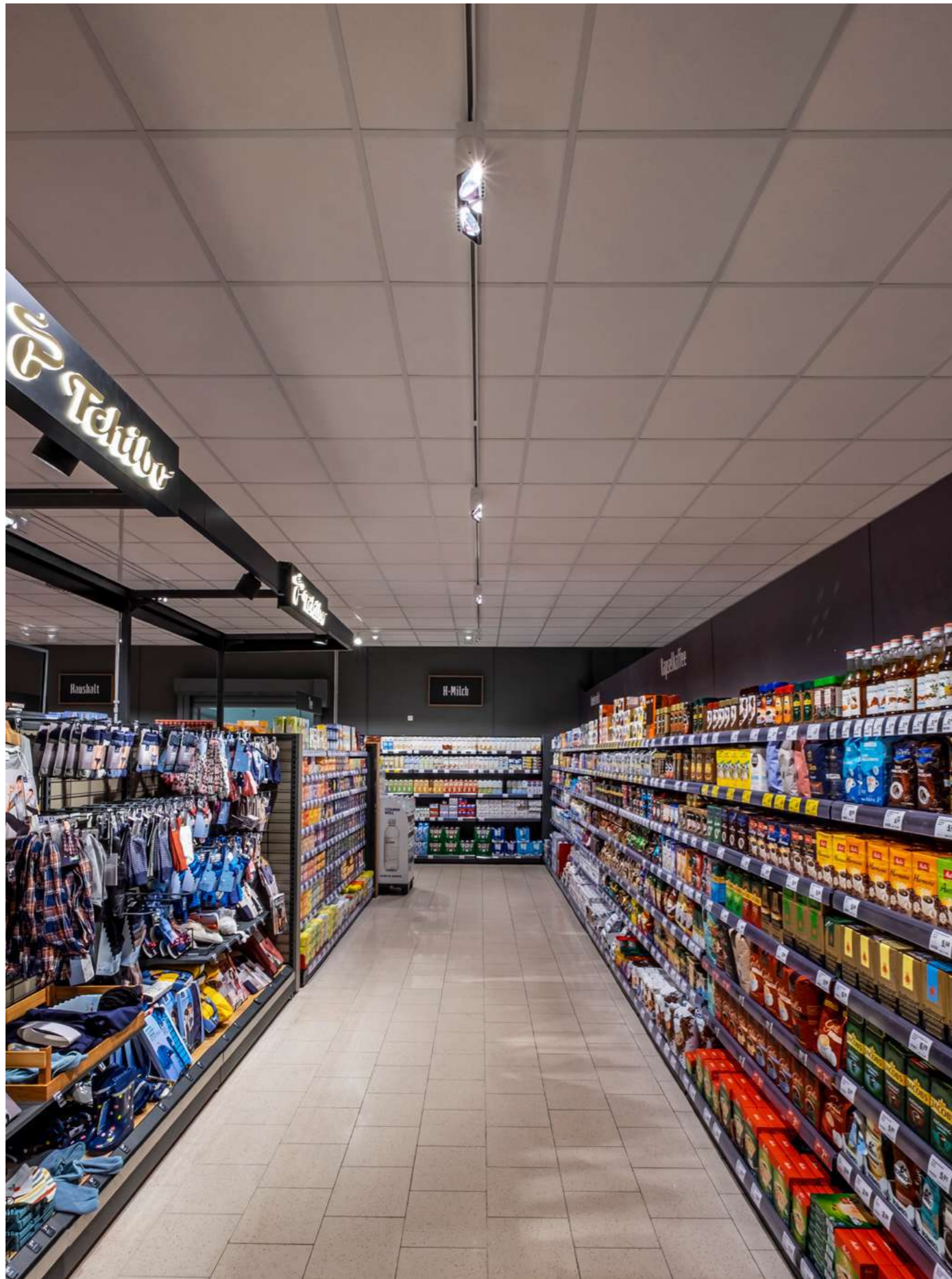



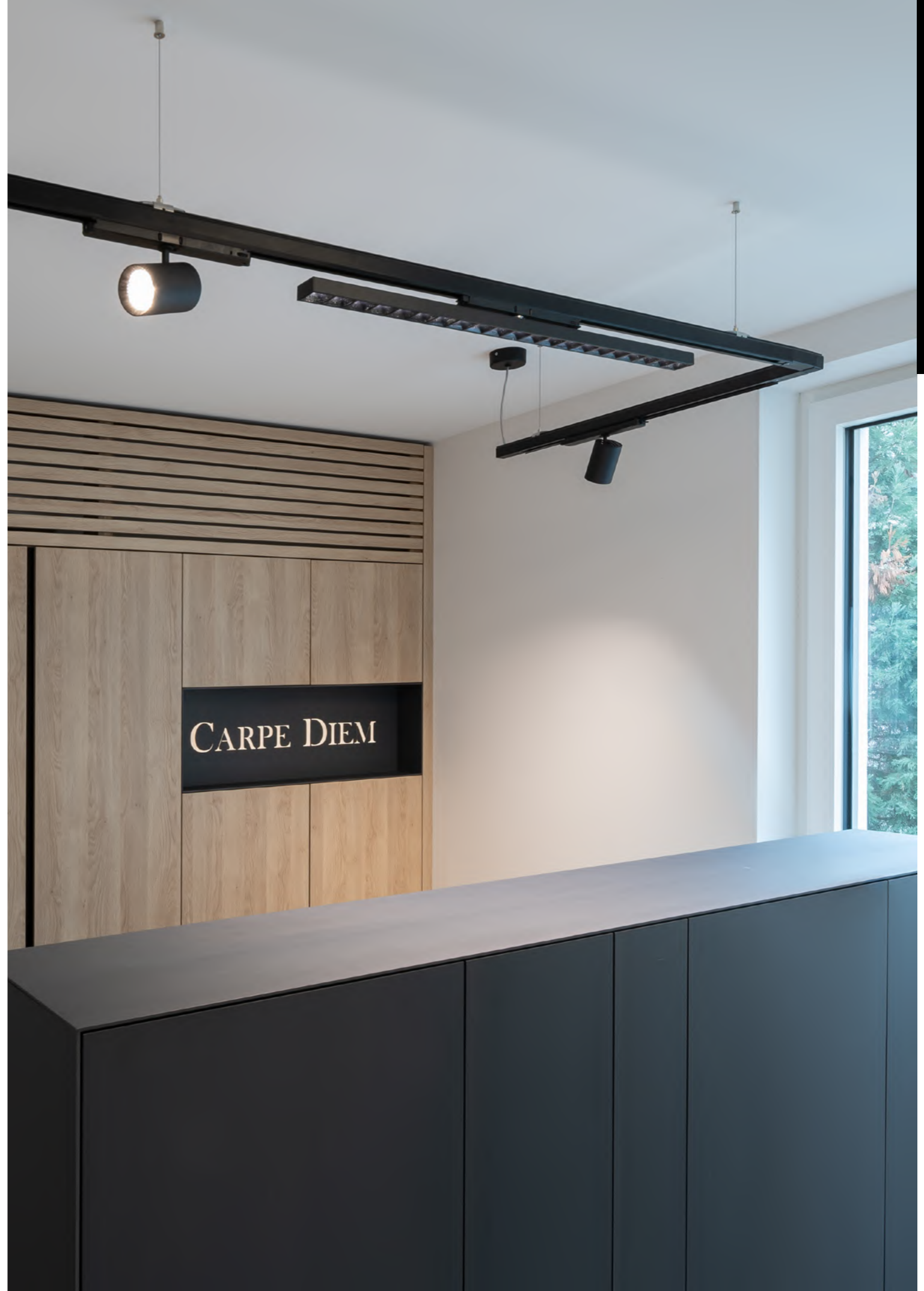





















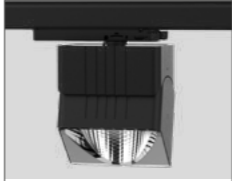

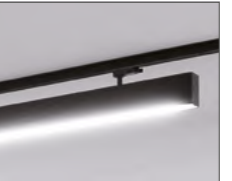
Referenz: REWE, Troisdorf/Bergheim, Deutschland, Photo: Alexander Schwarz, Produkt: ARTIS 2 TRACK

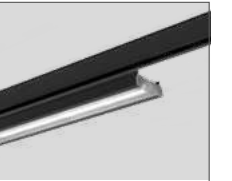

Projekt: Carpe Diem, Linz, Österreich, Photo: Joachim Rauch, Produkt: VARIDO TRACK, MOVA S TRACK



# Schienenstrahler und Leuchten aus dem Molto Luce Programm

 <b>2 GO TRACK</b> 	 <b>SHOPSTAR LEAN TRACK</b> 	 <b>MOVA M TRACK</b> 	 <b>MOVA S TRACK</b> 	 <b>MOVA S GU10 TRACK</b> 
 <b>LITIN 2 TRACK</b> 	 <b>DASH 2 TRACK</b> 	 <b>ARTIS 1 / 2 TRACK</b>  	 <b>LOG OUT 2.1 TRACK</b> 	 <b>TRAIL TRACK</b> 
 <b>VALO TRACK</b> 	 <b>VARIDO TRACK</b> 	 <b>3-PHASE TRACK</b> 		



## DESCO M TRACK

INFORMATION	LEISTUNG	LUMEN	CRI>	KELVIN	Ø x H	FARBE	ART.NR.
Leuchte mit integriertem 3-Phasen-Adapter und Pende, Aluminium, pulverbeschichtet, rund, direkt strahlend, opaler Diffuser, Lichtfarbe einstellbar mittels Schalter auf der LED-Platine, inkl. Konverter	SYS 15W	1005/983/972	90	2700/3000/4000	240 x 50	weiß	341-t2419150
	SYS 15W	1005/983/972	90	2700/3000/4000	240 x 50	schwarz	341-t2419160

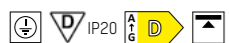



## DAS KLEINSTE 2-PHASEN SCHIENENSYSTEM DER WELT

Die Alternative für Menschen, die das Zarte und das Besondere suchen. Minimalismus und Purismus werden in einer 230V 2-Phasen Schiene mit 18x18mm vereint. Volare ist weltweit das kleinste 2-Phasen-Stromschienensystem. Einfachste Montage der Schienen direkt an Wand oder Decke durch vorgebohrte Löcher oder als abgehängte Versionen mittels Seil oder Stangen. Der neue Adapter besticht nicht nur durch seine kompakte Bauform, sondern ist auch völlig unkompliziert in der Schiene zu fixieren.

# VOLARE



Projekt: IDEAMED GmbH, München, Deutschland, Foto: Alexander Schwarz, Produkt: DASH 2 VOLARE, BIVIO VOLARE



Projekt: CARDI SHOWROOM, Stockholm, Schweden, Produkt: LOON VOLARE, VIBO VOLARE



Projekt: Molto Luce, München, Deutschland, Foto: Rauch Joachim, Produkt: LITIN 2 PD VOLARE



Projekt: MODE KÖCK, Kirchberg am Wechsel, Österreich, Photo: Joachim Rauch, Produkt: MOVA S VOLARE







































Projekt: Mehler & Hamberger, Traunstein, Deutschland, Foto: Joachim Rauch, Produkt: TRIGGA VOLARE



Bildretusche iStockphoto, Produkt: DARK NIGHT XS VOLARE, MOVA S L VOLARE VOLARE

# 2-Phasen Schienensystem Volare aus dem Molto Luce Programm



 <p>BIVIO VOLARE</p> 	 <p>CORPA VOLARE</p> 	 <p>LOON VOLARE</p> 	 <p>TRIGGA LOON VOLARE</p> 	 <p>LEO 1 / LEO 2 VOLARE</p> 
 <p>TRIGGA VOLARE</p> 	 <p>DIVO VOLARE</p> 	 <p>DARK NIGHT XS VOLARE</p> 	 <p>FIUME VOLARE</p> 	 <p>LITIN 2 PD VOLARE</p> 
 <p>MOVA S VOLARE</p> 	 <p>DASH 2 VOLARE</p> 	 <p>TRIGGA SPOT VOLARE</p> 	 <p>VIBO VOLARE</p> 	 <p>LITIN 2 VOLARE</p> 
 <p>CONTE VOLARE</p> 	 <p>V-LINE VOLARE</p> 	 <p>VOLARE TRACK</p> 		



# OFFICE





## RUBE PDI

### INFORMATION

Ultraschlanke LED Hängeleuchte aus Aluminium, Oberfläche lackiert, Abdeckung mit Mikroprismenoptik, Sehr breitstrahlender Indirektanteil, inkl. 2500mm Abhängung und Baldachin  
L 500 x B 75 x H 38mm

UGR<19



LEISTUNG	LUMEN	CRI>	KELVIN	L x B x H	AUSFÜHRUNG	FARBE	ART.NR.
SYS 35W	3500	80	3000	1195 x 295 x 15	SCHALTBAR	weiß	757-lr1203700s
SYS 35W	3500	80	3000	1195 x 295 x 15	DALI DIMM	weiß	757-lr1203700dali
SYS 35W	3500	80	4000	1195 x 295 x 15	SCHALTBAR	weiß	757-lr1204700s
SYS 35W	3500	80	4000	1195 x 295 x 15	DALI DIMM	weiß	757-lr1204700dali
SYS 35W	3500	80	3000	1195 x 295 x 15	SCHALTBAR	schwarz	757-lr1203700bs
SYS 35W	3500	80	3000	1195 x 295 x 15	DALI DIMM	schwarz	757-lr1203700bdali
SYS 35W	3500	80	4000	1195 x 295 x 15	SCHALTBAR	schwarz	757-lr1204700bs
SYS 35W	3500	80	4000	1195 x 295 x 15	DALI DIMM	schwarz	757-lr1204700bdali
SYS 54W	5800	80	3000	1195 x 295 x 15	SCHALTBAR	weiß	757-lr12031050s
SYS 54W	5800	80	3000	1195 x 295 x 15	DALI DIMM	weiß	757-lr12031050dali
SYS 54W	5800	80	4000	1195 x 295 x 15	SCHALTBAR	weiß	757-lr12041050s
SYS 54W	5800	80	4000	1195 x 295 x 15	DALI DIMM	weiß	757-lr12041050dali
SYS 54W	5800	80	3000	1195 x 295 x 15	SCHALTBAR	schwarz	757-lr12031050bs
SYS 54W	5800	80	3000	1195 x 295 x 15	DALI DIMM	schwarz	757-lr12031050bdali
SYS 54W	5800	80	4000	1195 x 295 x 15	SCHALTBAR	schwarz	757-lr12041050bs
SYS 54W	5800	80	4000	1195 x 295 x 15	DALI DIMM	schwarz	757-lr12041050bdali
SYS 49W	5100	80	3000	1495 x 295 x 15	SCHALTBAR	weiß	757-lr15031050s
SYS 49W	5100	80	3000	1495 x 295 x 15	DALI DIMM	weiß	757-lr15031050dali
SYS 49W	5100	80	4000	1495 x 295 x 15	SCHALTBAR	weiß	757-lr15041050s
SYS 49W	5100	80	4000	1495 x 295 x 15	DALI DIMM	weiß	757-lr15041050dali
SYS 49W	5100	80	3000	1495 x 295 x 15	SCHALTBAR	schwarz	757-lr15031050bs
SYS 49W	5100	80	3000	1495 x 295 x 15	DALI DIMM	schwarz	757-lr15031050bdali
SYS 49W	5100	80	4000	1495 x 295 x 15	SCHALTBAR	schwarz	757-lr15041050bs
SYS 49W	5100	80	4000	1495 x 295 x 15	DALI DIMM	schwarz	757-lr15041050bdali
SYS 62W	6500	80	3000	1495 x 295 x 15	SCHALTBAR	weiß	757-lr15031400s
SYS 62W	6500	80	3000	1495 x 295 x 15	DALI DIMM	weiß	757-lr15031400dali
SYS 62W	6500	80	4000	1495 x 295 x 15	SCHALTBAR	weiß	757-lr15041400s
SYS 62W	6500	80	4000	1495 x 295 x 15	DALI DIMM	weiß	757-lr15041400dali
SYS 62W	6500	80	3000	1495 x 295 x 15	SCHALTBAR	schwarz	757-lr15031400bs
SYS 62W	6500	80	3000	1495 x 295 x 15	DALI DIMM	schwarz	757-lr15031400bdali
SYS 62W	6500	80	4000	1495 x 295 x 15	SCHALTBAR	schwarz	757-lr15041400bs
SYS 62W	6500	80	4000	1495 x 295 x 15	DALI DIMM	schwarz	757-lr15041400bdali

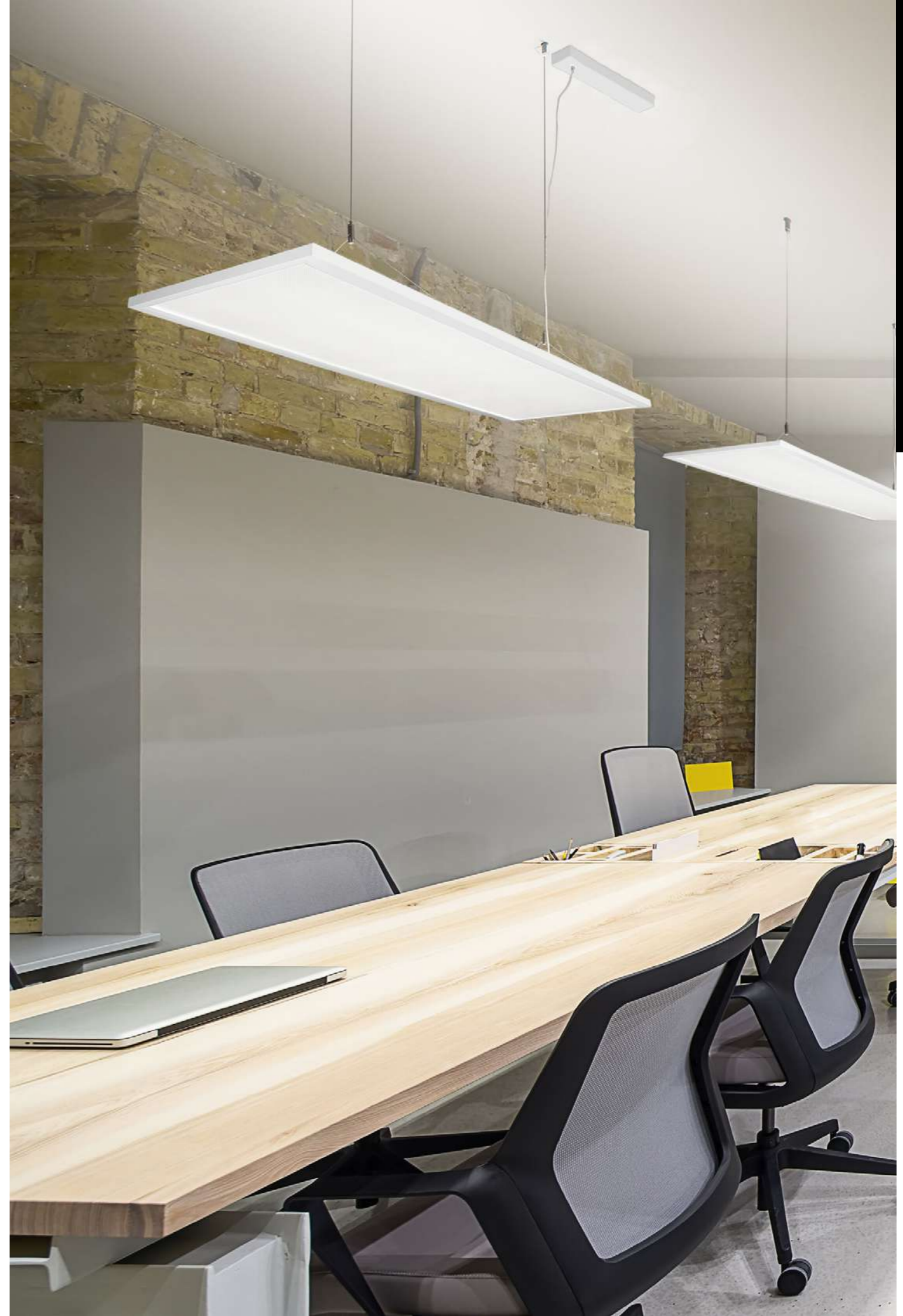

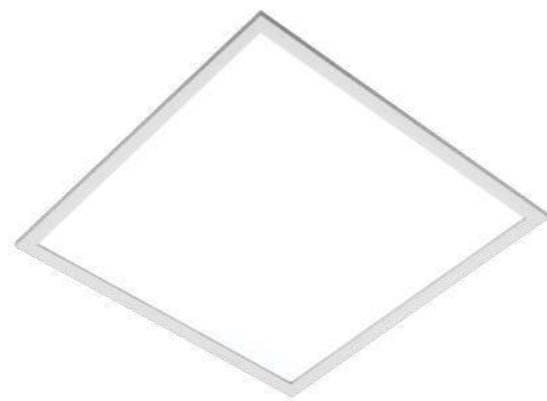

**FIT**

INFORMATION	DIFFUSER	LUMEN / W BEI 900mA	LUMEN / W BEI 1200mA	CRI>	KELVIN	L x B x H	ET	FARBE	ART.NR.
LED-Paneleinlegeleuchte, Aluminiumrahmen weiß lackiert, Modul 625, mit transluzenter PMMA Opal- oder nanoprismatischer Abdeckung, Zubehör separat ordern Zu betreiben mit 900mA oder 1200mA (Konverter separat ordern)		<b>LED 35W</b>	<b>LED 57W</b>						
	OPAL	4400	5500	80	3000	622 x 622 x 15	55	weiß	<b>757-625pm30fitwok</b>
	OPAL	4400	5500	80	4000	622 x 622 x 15	55	weiß	<b>757-625pm40fitwok</b>
	NANOPRISMA (UGR <19)	4500	5700	80	3000	622 x 622 x 15	55	weiß	<b>757-625np30fitwok</b>
	NANOPRISMA (UGR <19)	4500	5700	80	4000	622 x 622 x 15	55	weiß	<b>757-625np40fitwok</b>
	KONVERTER SEPARAT ORDERN								
	NICHT DIMMBAR	<b>757-k900s</b>	<b>757-k1200s</b>						
	DALI DIMMBAR	<b>757-k900d</b>	<b>757-k1200d</b>						

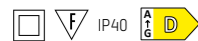

UGR<19 = Nanoprismatische Ausführung



**FIT LONG**

INFORMATION	DIFFUSER	LUMEN / W BEI 900mA	LUMEN / W BEI 1200mA	CRI>	KELVIN	L x B x H	ET	FARBE	ART.NR.
LED-Paneleinlegeleuchte, Aluminiumrahmen weiß lackiert, Modul 625, mit transluzenter PMMA Opal- oder nanoprismatischer Abdeckung, Zubehör separat ordern Zu betreiben mit 900mA oder 1200mA (Konverter separat ordern)		<b>LED 35W</b>	<b>LED 57W</b>						
	OPAL	4100	5500	80	3000	1246 x 310 x 15	55	weiß	<b>757-1250pm30fitwok</b>
	OPAL	4100	5500	80	4000	1246 x 310 x 15	55	weiß	<b>757-1250pm40fitwok</b>
	NANOPRISMA (UGR <19)	4200	5700	80	3000	1246 x 310 x 15	55	weiß	<b>757-1250np30fitwok</b>
	NANOPRISMA (UGR <19)	4200	5700	80	4000	1246 x 310 x 15	55	weiß	<b>757-1250np40fitwok</b>
	KONVERTER SEPARAT ORDERN								
	NICHT DIMMBAR	<b>757-k900s</b>	<b>757-k1200s</b>						
	DALI DIMMBAR	<b>757-k900d</b>	<b>757-k1200d</b>						



UGR<19 = Nanoprismatische Ausführung

AUFBAURAHMEN FIT	INFO	L x B x H	FARBE	ART.NR.
	Aufbaurahmen für LED Pannelleuchte FIT, weiß lackiert, Panel wird in den Aufbaurahmen eingelegt.	628 x 628 x 45	weiß	<b>757-625abr</b>

EINBAURAHMEN FIT	INFO	L x B x H	DA L x B	FARBE	ART.NR.
	Einbaurahmen für gesägte Deckenöffnungen. z.B. Trockenbaudecke etc. Für LED Pannelleuchte FIT Panel wird in den Einbaurahmen eingelegt.	660 x 660 x 88	645 x 645	weiß	<b>757-625ebr</b>

AUFBAURAHMEN FIT LONG	INFO	L x B x H	FARBE	ART.NR.
	Aufbaurahmen für LED Pannelleuchte FIT LONG, weiß lackiert, Panel wird in den Aufbaurahmen eingelegt.	1251 x 318 x 45	weiß	<b>757-1250abr</b>

EINBAURAHMEN FIT LONG	INFO	L x B x H	DA L x B	FARBE	ART.NR.
	Einbaurahmen für gesägte Deckenöffnungen. z.B. Trockenbaudecke etc. Für LED Pannelleuchte FIT LONG LED Panel wird in den Einbaurahmen eingelegt.	1285 x 360 x 88	1270 x 335	weiß	<b>757-1250ebr</b>

SEILABHÄNGESET	INFO	L	ART.NR.
	Seilabhängeset 2m für LED Pannelleuchten FIT & FIT LONG, weiß lackiert	2000	<b>757-zhuni2</b>

EINSPEISESET	INFO	L	QUERSCHNITT	FARBE	ART.NR.
	Einspeiseset für LED Pannelleuchte FIT & FIT LONG bestehend aus: Baldachin weiß inkl. Zugentlastung transp., Baldachin: 80x80x30 mm	2200	3x 0,75 mm	weiß	<b>757-bk3w</b>
		2200	5x 0,75 mm	weiß	<b>757-bk5w</b>

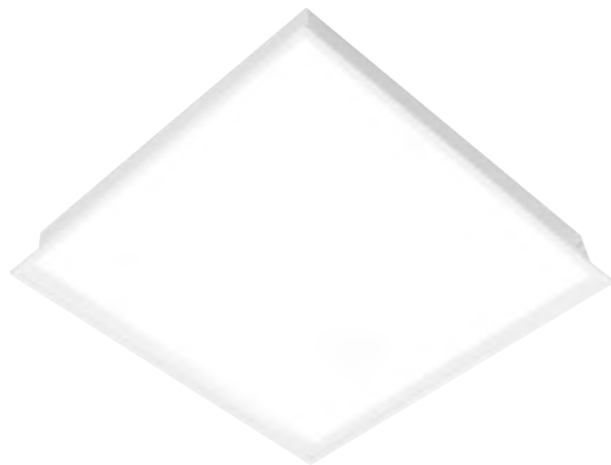

**IBP**

**INFORMATION**

LED-Paneleinlegeleuchte, Stahlblech, PMMA- oder nanopris-matische Abdeckung, inkl. LED Konverter, Zubehör separat ordern

LEISTUNG	LUMEN	CRI>	KELVIN	L x B x ET	DIFFUSER	AUSFÜHRUNG	FARBE	ART.NR.
SYS 32W	4100	80	3000	622 x 622 x 200	OPAL	SCHALTBAR	weiß	757-I6006
SYS 32W	4100	80	4000	622 x 622 x 200	OPAL	SCHALTBAR	weiß	757-I6007
SYS 32W	4200	80	3000	622 x 622 x 200	NANOPRISMA	SCHALTBAR	weiß	757-I6008
SYS 32W	4200	80	4000	622 x 622 x 200	NANOPRISMA	SCHALTBAR	weiß	757-I6009
SYS 32W	4100	80	3000	622 x 622 x 200	OPAL	DALI DIMM	weiß	757-I6006dali
SYS 32W	4100	80	4000	622 x 622 x 200	OPAL	DALI DIMM	weiß	757-I6007dali
SYS 32W	4200	80	3000	622 x 622 x 200	NANOPRISMA	DALI DIMM	weiß	757-I6008dali
SYS 32W	4200	80	4000	622 x 622 x 200	NANOPRISMA	DALI DIMM	weiß	757-I6009dali



EINBAURAHMEN INFO	ABBILDUNG	L x B x H	DA L x B	FARBE	ART.NR.
Einbaurahmen für gesäg-te Deckenöffnungen. z.B. Trockenbaudecke etc. Für LED Panneleuchte IBP Panel wird in den Einbaurahmen eingelegt.		660 x 660 x 88	645 x 645	weiß	757-625ebrw



**US**

**INFORMATION**

LED-Paneleinlegeleuchte, Aluminium-rahmen weiß lackiert, Modul 600, mit nanopris-matischer Abdeckung, zu betrei-ben mit 700mA oder 1050mA (Konverter separat ordern)

LUMEN / W bei 700mA	LUMEN / W bei 1050mA	CRI>	KELVIN	L x B x H	ET	FARBE	DIFFUSER	ART.NR.
<b>LED 24W</b>	<b>LED 36W</b>							
2900	4100	80	3000	596 x 596 x 15	55	weiß	nanoprisma	757-600np30uswok
2900	4100	80	4000	596 x 596 x 15	55	weiß	nanoprisma	757-600np40uswok
KONVERTER SEPARAT ORDERN								
<b>757-k700s</b>	<b>757-k1050s</b>	NICHT DIMMBAR						
<b>757-k700d</b>	<b>757-k700d</b>	DALI DIMMBAR						



UGR<19





### LLLX

#### INFORMATION

LED Aufbauleuchte, mit individuellem BAP-Raster in matter Ausführung, Stahlblech weiß lackiert, inkl. LED Konverter, auf Anfrage auch als Pendelversion erhältlich

LEISTUNG	LUMEN	CRI>	KELVIN	L x B x ET	FARBE	ART.NR.
SYS 37W	4000	80	3000	1258 x 264 x 60	weiß	757-I2050
SYS 37W	4000	80	4000	1258 x 264 x 60	weiß	757-I2051
SYS 57W	6200	80	3000	1558 x 264 x 60	weiß	757-I2052
SYS 57W	6200	80	4000	1558 x 264 x 60	weiß	757-I2053

UGR < 19



IP20





# Weitere Officeleuchten aus dem Molto Luce Programm

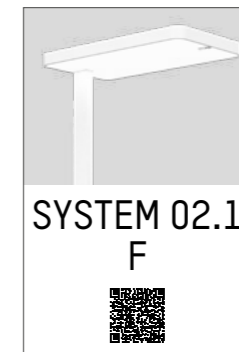
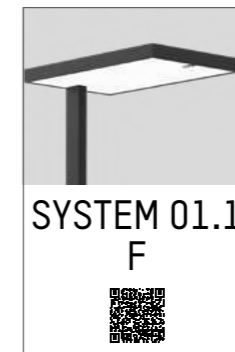
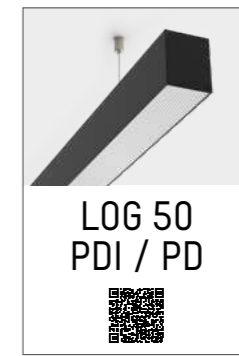

# TECHNISCHE BELEUCHTUNG





# TRAIL®

THE FLEXIBLE TRUNKING SYSTEM

## DURCHGANGSVERDRAHTUNG & VERBINDUNSSYSTEM

- individuelle Anordnung aller Lichteinsätze
- hohe Zeitersparnis bei der Montage

## ZUKUNFTSSICHER

- die Anordnung des Systems kann einfach verändert oder erweitert werden

## NEUE LICHTEINSÄTZE & OPTIKEN

- blendfreier Sehkomfort und absolut homogene Lichtverteilung

## NEUE EINSÄTZE FÜR DEN HANDEL – MOVA & ARTIS

- effiziente vertikale Beleuchtung und viele Möglichkeiten der Warenpräsentation

## LICHT & BEWEGUNGSSTEUERUNG

- neue Sensorenfamilie für hohe Energieeinsparung und CO<sub>2</sub> Reduktion





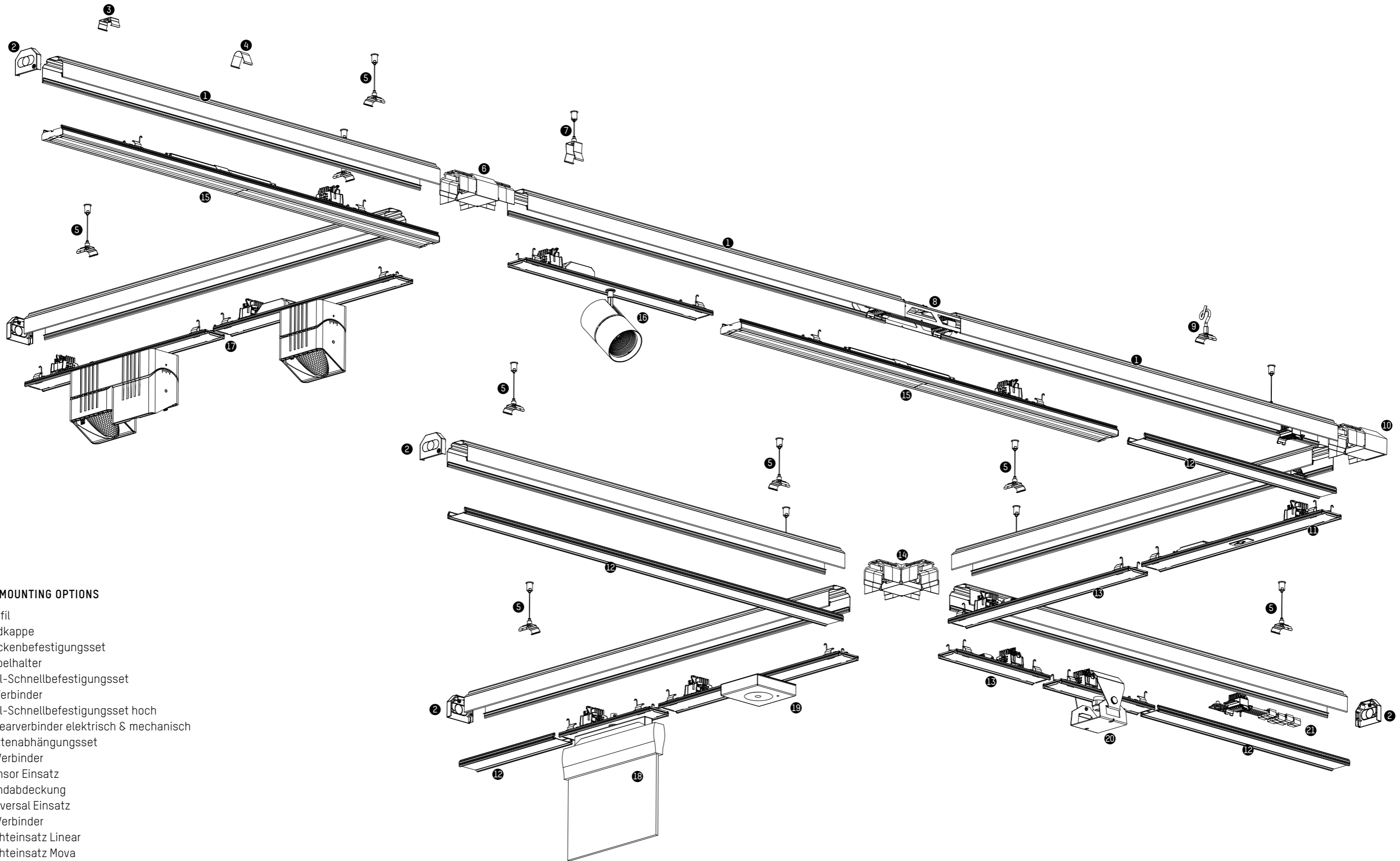

**TRAIL MOUNTING OPTIONS**

- ① Profil
- ② Endkappe
- ③ Deckenbefestigungsset
- ④ Kabelhalter
- ⑤ Seil-Schnellbefestigungsset
- ⑥ T-Verbinder
- ⑦ Seil-Schnellbefestigungsset hoch
- ⑧ Linearverbinder elektrisch & mechanisch
- ⑨ Kattenabhängungsset
- ⑩ L-Verbinder
- ⑪ Sensor Einsatz
- ⑫ Blindabdeckung
- ⑬ Universal Einsatz
- ⑭ X-Verbinder
- ⑮ Lichteinsatz Linear
- ⑯ Lichteinsatz Mova
- ⑰ Lichteinsätze Artis
- ⑱ Lichteinsatz Rettungszeichen
- ⑲ Lichteinsatz Sicherheitsleuchte
- ⑳ High Bay Einsatz
- ㉑ Einspeisung flexibel



Lagerhalle: 3500m<sup>2</sup>, Montagehöhe: 6m, Installierte Beleuchtungsstärke: 300lx, Trail Lichteinsatz Medium Beam (60°), High Efficiency (HE), DALI

## LICHTVERTEILUNG

Effiziente Linsen sorgen für einen blendfreien Sehkomfort und eine absolut homogene Lichtverteilung. TRAIL Lichteinsätze sind verfügbar mit unterschiedlichen Ausstrahlwinkeln für verschiedenste Anwendungsbereiche.

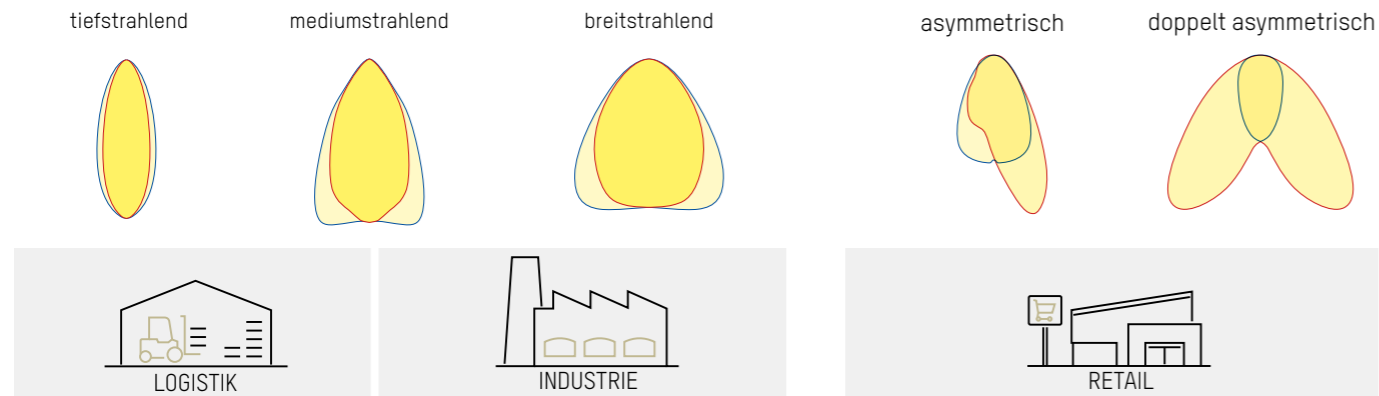

## EFFIZIENZ

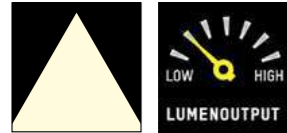

### HIGH EFFICIENCY LICHTEINSATZ

Applikationsspezifische Optiken bis zu UGR<19 sorgen für absolut blendfreie Lichtlösungen und hohe Energieeffizienz (bis zu 180lm/W) zur Reduktion des Stromverbrauchs

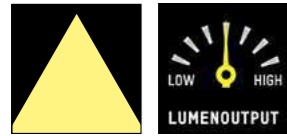

### MID OUTPUT LICHTEINSATZ

Die optimale Kombination aus Energieeffizienz und Lumen-Output für mittlere Montagehöhen im Industriebereich (z.B. Produktionshallen oder Lagerflächen)



### HIGH OUTPUT LICHTEINSATZ

Perfekter Sehkomfort (UGR<22) bei höheren Lumenwerten von bis zu 20.000 lm ermöglicht maximale Effizienz auch für hohe Montageanwendungen

## LICHTSTEUERUNG

TRAIL Lichteinsätze sind mit ON/OFF, DALI und DALI-2 Vorschaltgeräten für verschiedene Steuerungsmöglichkeiten bestückt. HIGH OUTPUT Lichteinsätze werden standardmäßig mit DALI-2 EVGs mit integrierter Stromversorgung ausgestattet. Die ideale Kombination mit TRAIL Sensoren ermöglicht es, die leuchtenspezifischen Daten für Predictive Maintenance and Diagnostics zu verwenden.

## ARTIKELNUMMER ERGÄNZEN

R = ABSTRAHLUNG	WW = LICHTFARBE	XX = FARBE	Y = DIMMBAR
asymmetrisch = 1	LED 3000K = 19 CRI>80	silber = 04 -9% Lumenoutput	schaltbar = 0
doppelasymmetrisch = 2	LED 3500K = 17 CRI>80	weiß = 05	DALI = d
breitstrahlend = 3	LED 4000K = 14 CRI>80	schwarz = 06 -13% Lumenoutput	DALI-2 = 2 (nur für HIGH OUTPUT)
tiefstrahlend = 4	LED 5000K = 15 CRI>80		
mediumstrahlend = 5	LED 6500K = 16 CRI>80		
breitstrahlend = 7 UGR<22			
high rack = 8			

## LICHTEINSATZ HIGH EFFICIENCY



Systemeinsatz in 3 Längen, Oberfläche pulverbeschichtet, 7 verschiedene Abstrahlcharakteristiken, mit hoher Energieeffizienz, schaltbar oder DALI dimmbar, 220-240V, 50/60Hz, 7-polig

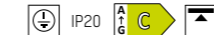

LEISTUNG	L x B	ABSTRAHLWINKEL	LM/3000K LM/3500K	LM/4000K LM/5000K LM/6500K	ART.NR.
SYS 25W	1137x64	asymmetrisch	3820	4020	610-1251011RWWXXY
		doppelasymmetrisch	3820	4020	
		breitstrahlend	4030	4250	
		tiefstrahlend	4030	4250	
		mediumstrahlend	4160	4390	
		breitstrahlend UGR<22	4030	4250	
		high rack	4120	4340	
SYS 37W	1696x64	asymmetrisch	5730	6030	610-1252011RWWXXY
		doppelasymmetrisch	5730	6030	
		breitstrahlend	6050	6380	
		tiefstrahlend	6050	6380	
		mediumstrahlend	6250	6580	
		breitstrahlend UGR<22	6050	6380	
		high rack	6180	6510	
SYS 49W	2255x64	asymmetrisch	7640	8050	610-1253011RWWXXY
		doppelasymmetrisch	7640	8050	
		breitstrahlend	8070	8510	
		tiefstrahlend	8070	8510	
		mediumstrahlend	8330	8780	
		breitstrahlend UGR<22	8070	8510	
		high rack	8240	8690	

## LICHTEINSATZ MID OUTPUT



Systemeinsatz in 3 Längen, Oberfläche pulverbeschichtet, 7 verschiedene Abstrahlcharakteristiken, mit mittlerem Lumenoutput, schaltbar oder DALI dimmbar, 220-240V, 50/60Hz, 7-polig

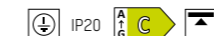

LEISTUNG	L x B	ABSTRAHLWINKEL	LM/3000K LM/3500K	LM/4000K LM/5000K LM/6500K	ART.NR.
SYS 40W	1137x64	asymmetrisch	5940	6260	610-1251021RWWXXY
		doppelasymmetrisch	5940	6260	
		breitstrahlend	6280	6620	
		tiefstrahlend	6280	6620	
		mediumstrahlend	6480	6830	
		breitstrahlend UGR<22	6280	6620	
		high rack	6410	6760	
SYS 60W	1696x64	asymmetrisch	8910	9390	610-1252021RWWXXY
		doppelasymmetrisch	8910	9390	
		breitstrahlend	9420	9930	
		tiefstrahlend	9420	9930	
		mediumstrahlend	9720	10250	
		breitstrahlend UGR<22	9420	9930	
		high rack	9620	10140	
SYS 80W	2255x64	asymmetrisch	11880	12520	610-1253021RWWXXY
		doppelasymmetrisch	11880	12520	
		breitstrahlend	12560	13240	
		tiefstrahlend	12560	13240	
		mediumstrahlend	12960	13660	
		breitstrahlend UGR<22	12560	13240	
		high rack	12830	13520	

## LICHTEINSATZ HIGH OUTPUT



Systemeinsatz in 3 Längen, Oberfläche pulverbeschichtet, 7 verschiedene Abstrahlcharakteristiken, mit hohem Lumenoutput, schaltbar oder DALI dimmbar, 220-240V, 50/60Hz, 7-polig

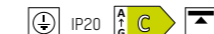

LEISTUNG	L x B	ABSTRAHLWINKEL	LM/3000K LM/3500K	LM/4000K LM/5000K LM/6500K	ART.NR.
SYS 61W	1137x64	asymmetrisch	8540	9010	610-1251031RWWXXY
		doppelasymmetrisch	8540	9010	
		breitstrahlend	9030	9520	
		tiefstrahlend	9030	9520	
		mediumstrahlend	9320	9830	
		breitstrahlend UGR<22	9030	9520	
		high rack	9220	9730	
SYS 92W	1696x64	asymmetrisch	12820	13520	610-1252031RWWXXY
		doppelasymmetrisch	12820	13520	
		breitstrahlend	13550	14280	
		tiefstrahlend	13550	14280	
		mediumstrahlend	13980	14750	
		breitstrahlend UGR<22	13550	14280	
		high rack	13840	14590	
SYS 122W	2255x64	asymmetrisch	17090	18020	610-1253031RWWXXY
		doppelasymmetrisch	17090	18020	
		breitstrahlend	18070	19050	
		tiefstrahlend	18070	19050	
		mediumstrahlend	18650	19660	
		breitstrahlend UGR<22	18070	19050	
		high rack	18450	19460	

### LICHTEINSATZ IP54 HIGH EFFICIENCY

INFORMATION  

Systemeinsatz in 3 Längen, Oberfläche pulverbeschichtet, 4 verschiedene Abstrahlcharakteristiken, mit hoher Energieeffizienz, schaltbar oder DALI dimmbar, 220-240V, 0/60Hz, 7-polig

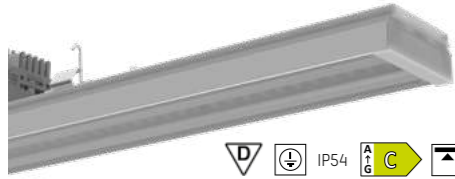

LEISTUNG	L x B	ABSTRAHLWINKEL	LM/3000K LM/3500K	LM/4000K LM/5000K LM/6500K	ART.NR.
SYS 25W	1137x64	opal	3770	3980	610-1254011RWWXXY
		mediumstrahlend	4060	4280	
		breitstrahlend	3930	4140	
		high rack	4160	4390	
SYS 37W	1696x64	opal	5660	5970	610-1255011RWWXXY
		mediumstrahlend	6090	6420	
		breitstrahlend	5890	6210	
		high rack	6240	6580	
SYS 49W	2255x64	opal	7550	7960	610-1256011RWWXXY
		mediumstrahlend	8130	8560	
		breitstrahlend	7860	8280	
		high rack	8330	8780	

### LICHTEINSATZ IP54 MID OUTPUT

INFORMATION  

Systemeinsatz in 3 Längen, Oberfläche pulverbeschichtet, 4 verschiedene Abstrahlcharakteristiken, mit mittlerem Lumenoutput, schaltbar oder DALI dimmbar, 220-240V, 50/60Hz, 7-polig

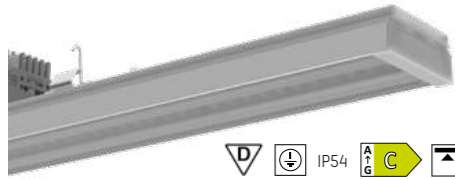

LEISTUNG	L x B	ABSTRAHLWINKEL	LM/3000K LM/3500K	LM/4000K LM/5000K LM/6500K	ART.NR.
SYS 40W	1137x64	opal	5870	6190	610-1254021RWWXXY
		mediumstrahlend	6320	6660	
		breitstrahlend	6110	6440	
		high rack	6480	6830	
SYS 60W	1696x64	opal	8810	9290	610-1255021RWWXXY
		mediumstrahlend	9480	9990	
		breitstrahlend	9170	9670	
		high rack	9720	10240	
SYS 80W	2255x64	opal	11750	12390	610-1256021RWWXXY
		mediumstrahlend	12640	13330	
		breitstrahlend	12230	12890	
		high rack	12960	13660	

### LICHTEINSATZ IP54 HIGH OUTPUT

INFORMATION  

Systemeinsatz in 3 Längen, Oberfläche pulverbeschichtet, 4 verschiedene Abstrahlcharakteristiken, mit hohem Lumenoutput, schaltbar oder DALI dimmbar, 220-240V, 50/60Hz, 7-polig

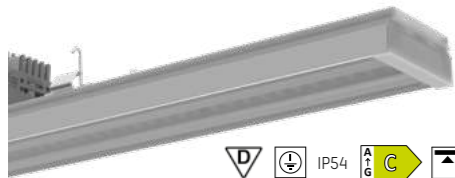

LEISTUNG	L x B	ABSTRAHLWINKEL	LM/3000K LM/3500K	LM/4000K LM/5000K LM/6500K	ART.NR.
SYS 61W	1137x64	opal	8450	8910	610-1254031RWWXXY
		mediumstrahlend	9090	9590	
		breitstrahlend	8800	9270	
		high rack	9320	9820	
SYS 92W	1696x64	opal	12680	13370	610-1255031RWWXXY
		mediumstrahlend	13640	14380	
		breitstrahlend	13200	13910	
		high rack	13980	14740	
SYS 122W	2255x64	opal	16910	17830	610-1256031RWWXXY
		mediumstrahlend	18190	19180	
		breitstrahlend	17600	18550	
		high rack	18640	19650	

### ARTIKELNUMMER ERGÄNZEN

R = ABSTRAHLUNG	WW = LICHTFARBE	XX = FARBE	Y = DIMMBAR
opal = 0	LED 3000K = 19 CRI>80	weiß = 05	schaltbar = 0
mediumstrahlend = 5 / UGR<19	LED 3500K = 17 CRI>80		DALI dimm. = d
breitstrahlend = 7 / UGR<22	LED 4000K = 14 CRI>80		DALI-2 = 2 (nur für HIGH OUTPUT)
high rack = 8	LED 5000K = 15 CRI>80		
	LED 6500K = 16 CRI>80		

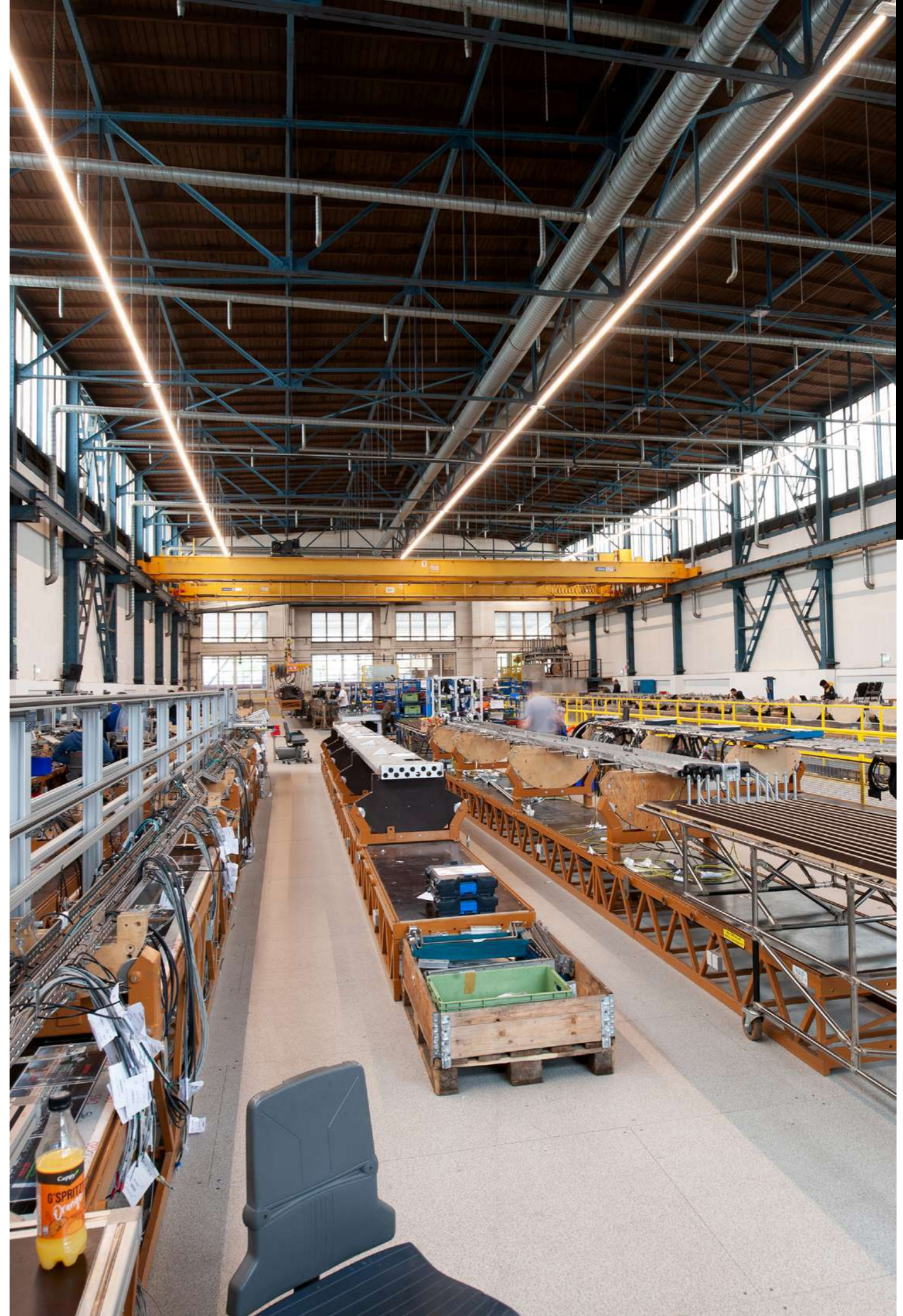

### LICHTEINSATZ CUBIC HIGH EFFICIENCY

INFORMATION  

Systemeinsatz in 3 Längen, Oberfläche pulverbeschichtet, 3 verschiedene Abstrahlcharakteristiken, mit hoher Energieeffizienz, schaltbar oder DALI dimmbar, 220-240V, 50/60Hz, 7-polig



LEISTUNG	L x B	ABSTRAHLWINKEL	LM/3000K LM/3500K	LM/4000K LM/5000K LM/6500K	ART.NR.
SYS 25W	1137x64	opal	3950	4160	610-1257011RWWXXY
		breitstrahlend	3950	4160	
		tiefstrahlend	3950	4160	
SYS 37W	1696x64	opal	5920	6240	610-1258011RWWXXY
		breitstrahlend	5920	6240	
		tiefstrahlend	5920	6240	
SYS 49W	2255x64	opal	7900	8320	610-1259011RWWXXY
		breitstrahlend	7900	8320	
		tiefstrahlend	7900	8320	

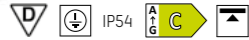

### LICHTEINSATZ CUBIC MID OUTPUT

INFORMATION  

Systemeinsatz in 3 Längen, Oberfläche pulverbeschichtet, 3 verschiedene Abstrahlcharakteristiken, mit mittlerem Lumenoutput, schaltbar oder DALI dimmbar, 220-240V, 50/60Hz, 7-polig

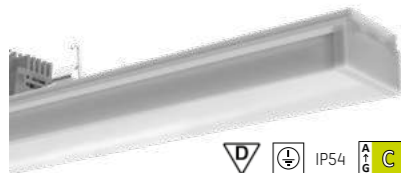

LEISTUNG	L x B	ABSTRAHLWINKEL	LM/3000K LM/3500K	LM/4000K LM/5000K LM/6500K	ART.NR.
SYS 40W	1137x64	opal	6140	6470	610-1257021RWWXXY
		breitstrahlend	6140	6470	
		tiefstrahlend	6140	6470	
SYS 60W	1696x64	opal	9210	9710	610-1258021RWWXXY
		breitstrahlend	9210	9710	
		tiefstrahlend	9210	9710	
SYS 80W	2255x64	opal	12290	12950	610-1259021RWWXXY
		breitstrahlend	12290	12950	
		tiefstrahlend	12290	12950	

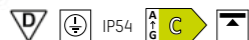

### LICHTEINSATZ CUBIC HIGH OUTPUT

INFORMATION  

Systemeinsatz in 3 Längen, Oberfläche pulverbeschichtet, 4 verschiedene Abstrahlcharakteristiken, mit hohem Lumenoutput, schaltbar oder DALI dimmbar, 220-240V, 50/60Hz, 7-polig



LEISTUNG	L x B	ABSTRAHLWINKEL	LM/3000K LM/3500K	LM/4000K LM/5000K LM/6500K	ART.NR.
SYS 61W	1137x64	opal	8840	9320	610-1257031RWWXXY
		breitstrahlend	8840	9320	
		tiefstrahlend	8840	9320	
SYS 92W	1696x64	opal	13260	13980	610-1258031RWWXXY
		breitstrahlend	13260	13980	
		tiefstrahlend	13260	13980	
SYS 122W	2255x64	opal	17680	18640	610-1259031RWWXXY
		breitstrahlend	17680	18640	
		tiefstrahlend	17680	18640	

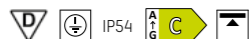

### ARTIKELNUMMER ERGÄNZEN

R = ABSTRAHLUNG	WW = LICHTFARBE	XX = FARBE	Y = DIMMBAR
opal = 0	LED 3000K = 19 CRI>80	weiß = 05	schaltbar = 0
breitstrahlend = 3	LED 3500K = 17 CRI>80		DALI dimm. = d
tiefstrahlend = 4	LED 4000K = 14 CRI>80		DALI-2 = 2 (nur für HIGH OUTPUT)
	LED 5000K = 15 CRI>80		
	LED 6500K = 16 CRI>80		

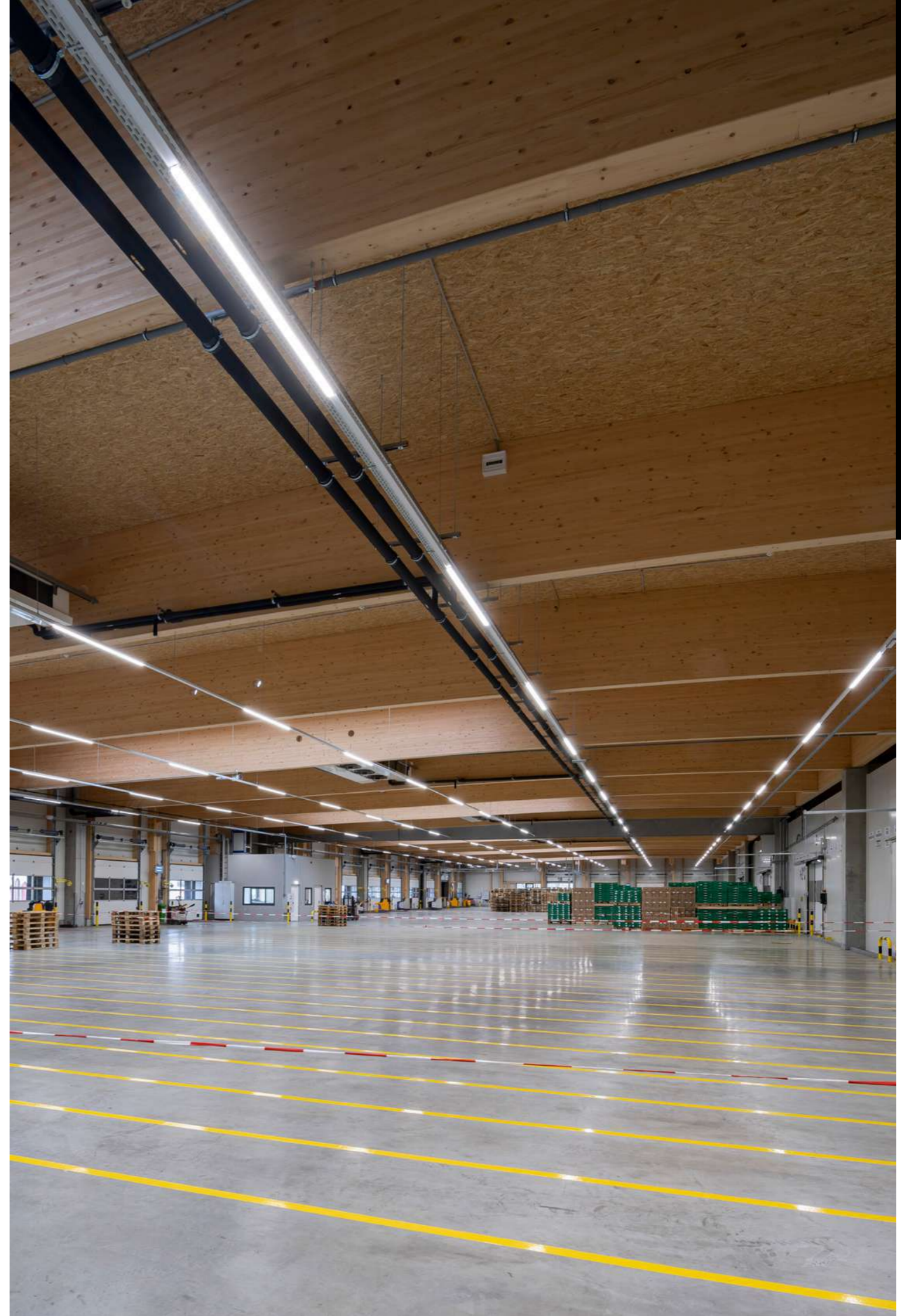

### LICHTEINSATZ OFFICE HIGH EFFICIENCY

INFORMATION  

Systemeinsatz in 3 Längen, Oberfläche pulverbeschichtet, Raster in basic oder dark, mit hoher Energieeffizienz, schaltbar oder DALI dimmbar, 220-240V, 50/60Hz, 7-polig

LEISTUNG	L x B	ABSTRAHLWINKEL	LM/3000K LM/3500K	LM/4000K	ART.NR.
SYS 21W	1137x64	basic	3220	3400	610-1263011RWWXXY
		dark	2730	2730	
SYS 32W	1696x64	basic	4570	5100	610-1264011RWWXXY
		dark	4090	4090	
SYS 42W	2255x64	basic	6450	6800	610-1265011RWWXXY
		dark	5770	6080	



### LICHTEINSATZ OFFICE MID OUTPUT

INFORMATION  

Systemeinsatz in 3 Längen, Oberfläche pulverbeschichtet, Raster in basic oder dark, schaltbar oder DALI dimmbar, 220-240V, 50/60Hz, 7-polig

LEISTUNG	L x B	ABSTRAHLWINKEL	LM/3000K LM/3500K	LM/4000K	ART.NR.
SYS 39W	1137x64	basic	5680	5990	610-1263021RWWXXY
		dark	5080	5350	
SYS 59W	1696x64	basic	8530	8990	610-1264021RWWXXY
		dark	7620	8030	
SYS 78W	2255x64	basic	11370	11980	610-1265021RWWXXY
		dark	10160	10710	

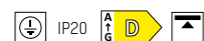
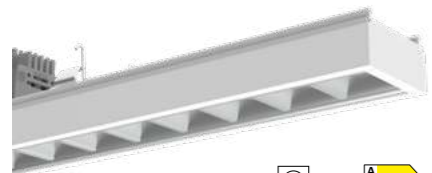

### ARTIKELNUMMER ERGÄNZEN

#### R = ABSTRAHLUNG

dark = **d** / UGR<16  
basic = **b** / UGR<19

#### WW = LICHTFARBE

LED 3000K = **19** CRI>80  
LED 3500K = **17** CRI>80  
LED 4000K = **14** CRI>80

#### XX = FARBE

silber = **04**  
weiß = **05**  
schwarz = **06**

#### Y = DIMMBAR

schaltbar = **0**  
DALI = **d**





EUROGAST / Leibnitz / Österreich, Verkaufsraum, Akzentbeleuchtung, Montagehöhe: 3,2m, Lichteinsatz Trail Spot, Medium Beam (60°), High Efficiency (HE)

## LICHTEINSATZ MOVA M

INFORMATION	LEISTUNG	L	LM/3000K	LM/3500K	LM/4000K	ART.NR.
Strahlereinsatz, Oberfläche pulverbeschichtet, 5 verschiedene Abstrahlcharakteristiken, schaltbar oder DALI dimmbar, 220-240V, 50/60Hz, 7-polig	SYS 27W	562mm	2770	2540	2900	610-0300031RWWXXY
	SYS 31W	562mm	3100	2840	3250	610-0300041RWWXXY
	SYS 40W	562mm	4100	3840	4300	610-0300051RWWXXY



### ARTIKELNUMMER ERGÄNZEN

R = ABSTRAHLUNG	WW = LICHTFARBE	XX = FARBE	Y = DIMMBAR
asymmetrisch = 1	LED 3000K = 49 PREMIUM CRI>90	silber = 44	schaltbar = 0
spot 17° = 4 (bei 40 W Version nicht möglich)	LED 3500K = 47 PREMIUM CRI>90	weiß = 55	DALI dimm. = d
medium 60° = 5	LED 4000K = 24 CRI>90	schwarz = 66	
flood 40° = 3			
wide flood 60° = 6 (bei 40 W Version nicht möglich)			

## LICHTEINSATZ ARTIS

INFORMATION	AUSFÜHRUNG	LEISTUNG	L	ABSTRAHLWINKEL	LM/3000K	LM/3500K	LM/4000K	ART.NR.
Strahlereinsatz, Oberfläche pulverbeschichtet, schaltbar oder DALI dimmbar, 220-240V, 50/60Hz, 7-polig	1-flammig	SYS 40W	562mm	asymmetrisch	3880	3940	4390	610-03510111WWXXY
	2-flammig	SYS 80W	562mm	doppelasymmetrisch	7760	7890	8780	610-03520112WWXXY



### LICHTEINSATZ ARTIS MATRIX

INFORMATION	AUSFÜHRUNG	LEISTUNG	L	ABSTRAHLWINKEL	LM/3000K	LM/3500K	LM/4000K	ART.NR.
Strahlereinsatz, Oberfläche pulverbeschichtet, schaltbar oder DALI dimmbar, 220-240V, 50/60Hz, 7-polig	1-flammig	SYS 40W	562mm	asymmetrisch	3880	3940	4390	610-03510311WWXXY
	2-flammig	SYS 80W	562mm	doppelasymmetrisch	7760	7890	8780	610-03520312WWXXY

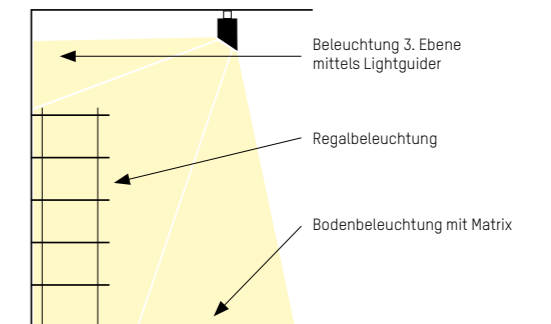

### ARTIKELNUMMER ERGÄNZEN

WW = LICHTFARBE	XX = FARBE	Y = DIMMBAR
LED 3000K = 49 PREMIUM CRI>90	silber = 44	schaltbar = 0
LED 3500K = 47 PREMIUM CRI>90	weiß = 55	DALI dimm. = d
LED 4000K = 24 CRI>90	schwarz = 66	

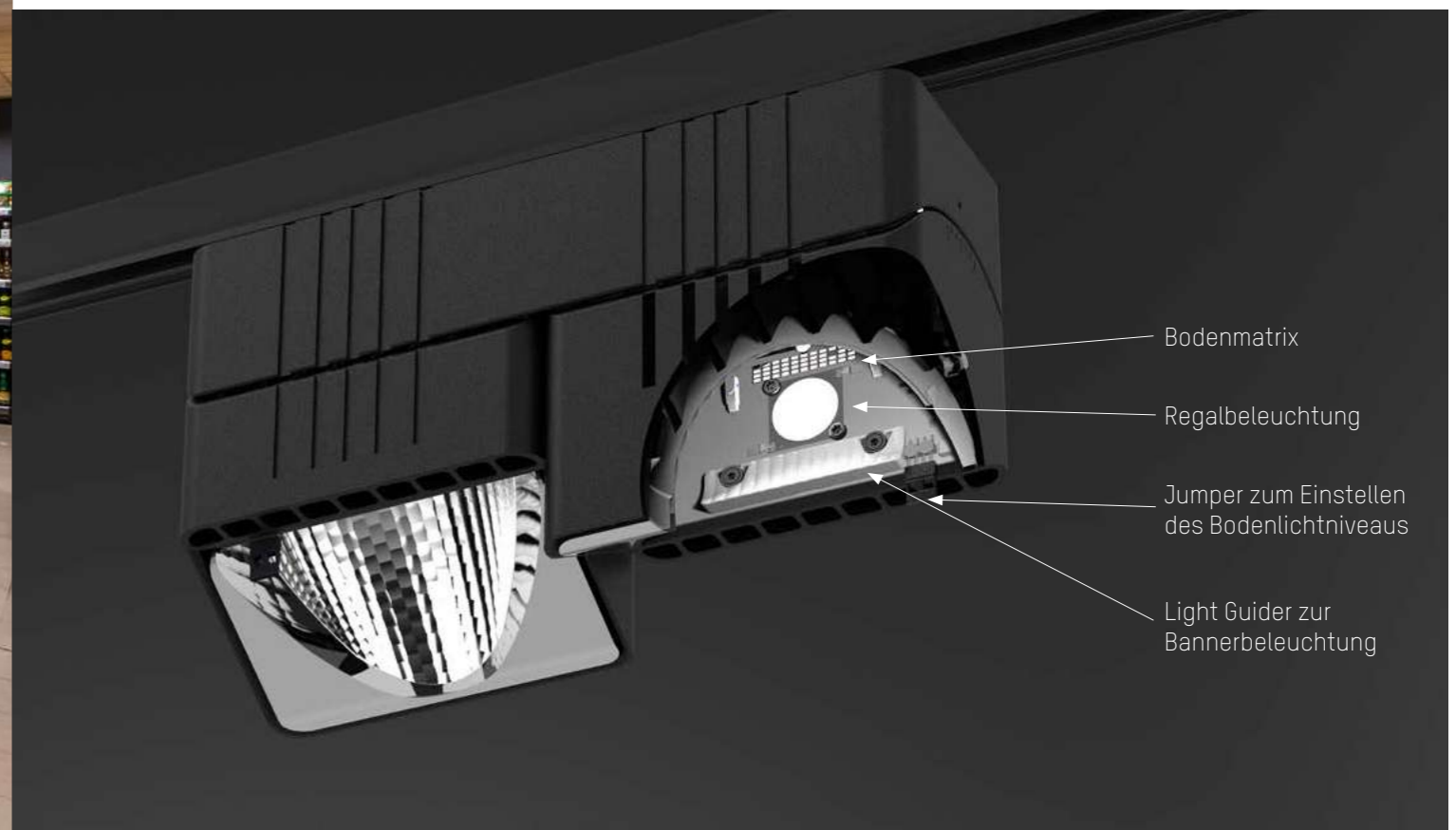



### UNIVERSAL HIGH BAY EINSATZ

#### INFORMATION

Systemeinsatz zur mechanischen Anbindung der kreisförmigen High Bay Leuchte an Trail, Tragkraft: bis zu 10kg, pro Position eine Abhängung notwendig, 220-240V, 50/60Hz



POLIG	B x H	ART.NR.
7-polig	93 x 112 mm	610-0275001000XX0
11-polig	93 x 112 mm	610-0275002000XX0

### TUNE HIGH BAY EINSATZ

#### INFORMATION

Systemeinsatz zur mechanischen Anbindung TUNE High Bay Leuchte an Trail, Tragkraft: bis zu 10kg, pro Position eine Abhängung notwendig, 220-240V, 50/60Hz Einsatz ist komplett verkabelt, inkl. Steckverbindung



POLIG	L x B x H	ART.NR.
7-polig	281 x 58 x 16	610-0283001000050
7-polig	281 x 58 x 16	610-0283001000040
7-polig	281 x 58 x 16	610-0283001000060
11-polig	281 x 58 x 16	610-0283002000050
11-polig	281 x 58 x 16	610-0283002000040
11-polig	281 x 58 x 16	610-0283002000060

### UNIVERSAL EINSATZ

#### INFORMATION

Universaleinsatz, Oberfläche pulverbeschichtet, zum Bestücken mit Sensoren, Notlichtleuchten, Lautsprechern, Spots oder Pendelleuchten (bauseits), 2 Längen erhältlich, mit Verbindungsklemme bis 5 x 2,5mm<sup>2</sup>, 220-240V, 50/60Hz

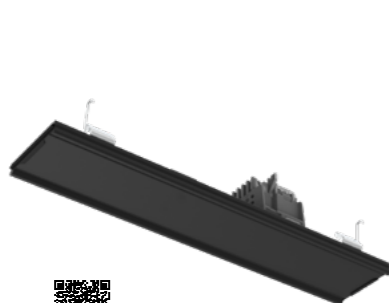

POLIG	L	ART.NR.
7-polig	281mm	610-0291001000XX0
11-polig	281mm	610-0291002000XX0
7-polig	562mm	610-0292001000XX0
11-polig	562mm	610-0292002000XX0

### LICHTEINSATZ SICHERHEITSLAUCHE

#### INFORMATION

Sicherheitsleuchten-Systemeinsatz, Akkulaufzeit 3h, inkl. Linse für Fluchtwegausleuchtung und Antipanikbeleuchtung, Abstand zwischen Leuchten 21m für eine normgerechte Ausleuchtung von 1lx, 220-240V, 50/60Hz, 11-polig

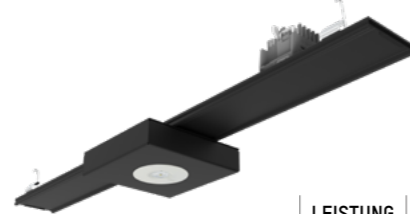

LEISTUNG	KELVIN	L	ART.NR.
SYS 6W	4000	565mm	610-0272002000XX0

### ARTIKELNUMMER ERGÄNZEN

- XX = FARBE
- silber = 04
- weiß = 05
- schwarz = 06



### LICHTEINSATZ RETTUNGSZEICHEN

#### INFORMATION

Rettungszeichenleuchte, Gehäuse aus selbstlöschendem Kunststoff, Aufladezeit: 12h, Erkennungsreichweite 32m, inkl. Piktogramm (1x links, 1x rechts, 2x nach unten) 220-240V, 50/60Hz, 11-polig



LEISTUNG	L x B x H	ART.NR.
SYS 1,7W	281 x 58 x 251	610-0271002000XX0

### ARTIKELNUMMER ERGÄNZEN

- XX = FARBE
- silber = 04
- weiß = 05
- schwarz = 06

### BEWEGUNGSMELDER EINSATZ

#### INFORMATION

Sensor ausgelegt als DALI-2 Controller, inkl. DALI-Bus-Versorgung, (kein bauseitiges DALI-Bus-System erforderlich) Mesh-Netzwerk zur Vernetzung der Sensoren, Parametrierung und Konfigurierung via Bluetooth-App, Konstantlicht-Regelung, Vordefinierte Szenen, Haupt- und Grundlicht frei einstellbar, freie Definition von Leuchtengruppen mit konfigurierbarem Verhalten, bis zu 16 DALI LED Treiber anschließbar - einfacher Sensortausch mit Zhaga Schnittstelle, 220-240V, 50/60Hz



POLIG	SENSOR	L	ART.NR.
7-polig	3360	562mm	610-027800100005m
11-polig	3360	562mm	610-027800200005m
POLIG	SENSOR	L	ART.NR.
7-polig	345	562mm	610-028000100005m
11-polig	345	562mm	610-028000200005m

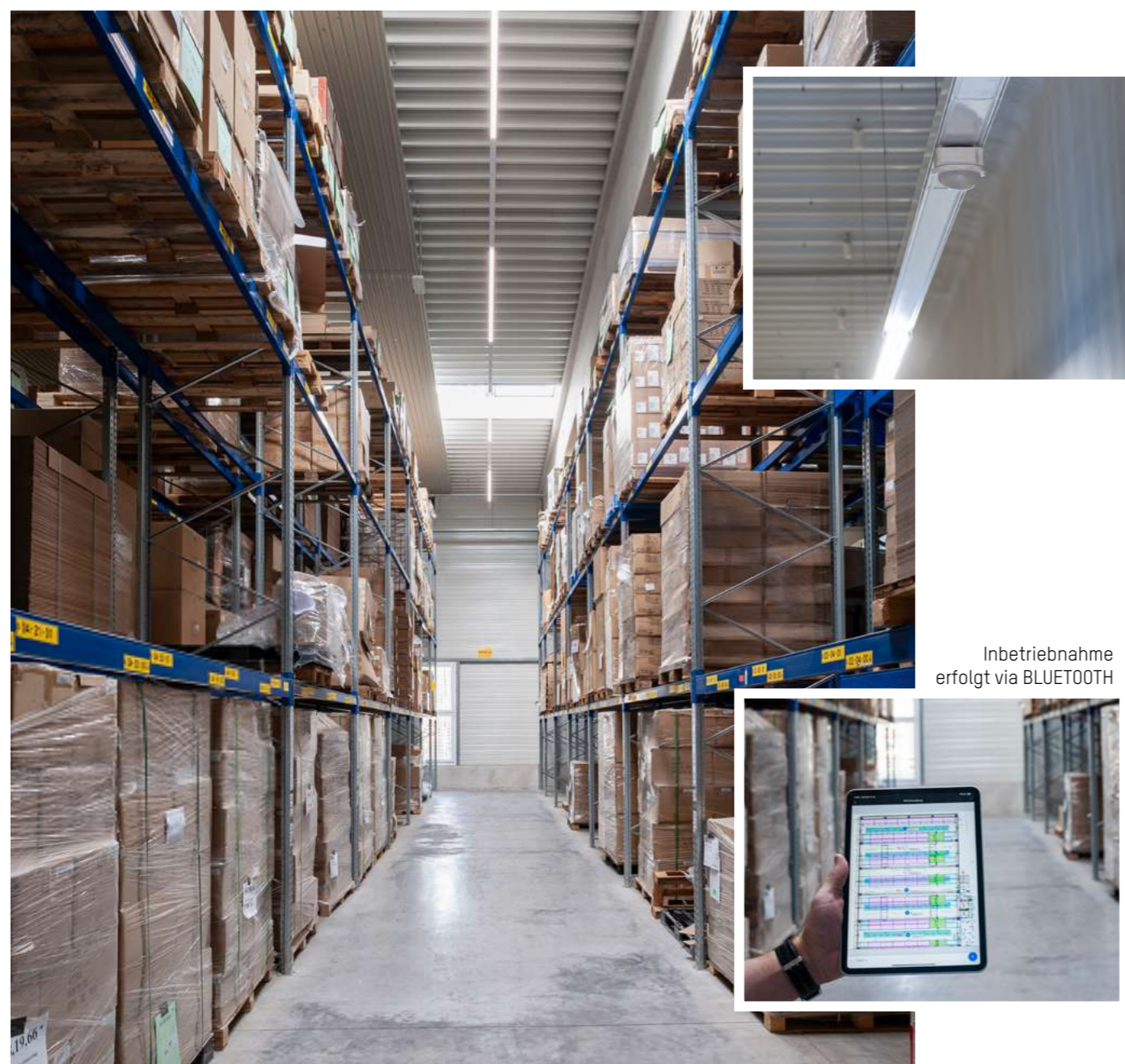

Inbetriebnahme erfolgt via BLUETOOTH

Hochregallager, Montagehöhe: 8m, Beleuchtungsstärke: 200lx, Trail Licht Einsatz, Narrow Beam (30°), High Efficiency (HE), DALI, Trail Sensoreinsatz DALI-2 Bluetooth Mesh, Licht- & Bewegungssteuerung

### BEWEGUNGSMELDER 3360

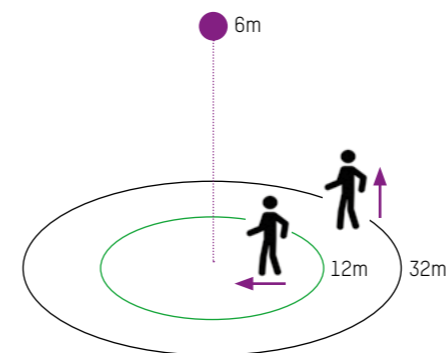

Mögliche Montagehöhe: 2.80 m – 14.00m  
Grün: radial / Schwarz: tangential

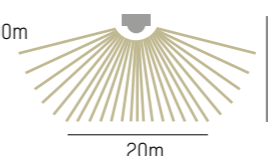

MONTAGEHÖHE	ERFASSUNGSBEREICH
14m	Ø 20m (tangential)
9m	Ø 28m (tangential)
6m	Ø 32m (tangential)
2m	Ø 36m (tangential)

### BEWEGUNGSMELDER 345

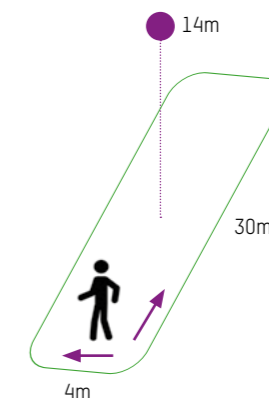

Mögliche Montagehöhe: 4.00 m – 14.00m  
Grün: radial und tangential



MONTAGEHÖHE	ERFASSUNGSBEREICH
14m	30 x 4m
10m	25 x 4m
8m	20 x 4m
6m	15 x 4m
4m	10 x 4m

### SENSOR ECO EINSATZ

#### INFORMATION

2-Kanal-Lichtsteuergerät mit DALI-Schnittstelle, Anschluss für bis zu 32 elektronische Vorschaltgeräte möglich, Licht- & Präsenzsensoren, Präsenzerfassungsbereich über integrierte Shutter zwischen 40 - 90° einstellbar, Integrierter Infrarot Empfänger, maximale Installationshöhe 5m, 220-240V, 50/60Hz

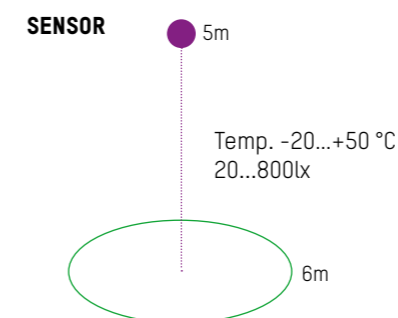

Mögliche Montagehöhe: max.5m  
Grün: Erfassungsbereich  
Arbeitsbereich Lichtsensor: 20 - 800lx  
Erfassungswinkel: 80°



### FERNBEDIENUNG SENSOR ECO EINSATZ

#### INFORMATION

IR-Fernbedienung [Master] für die Konfiguration und Inbetriebnahme des DALIeco Lichtsteuerungssystems, mit PC-Schnittstelle; Fernbedienung, USB Verbindungskabel, PC Software



ART.NR.
28-195967

### ARTIKELNUMMER ERGÄNZEN

- XX = FARBE
- silber = 04
- weiß = 05
- schwarz = 06

SYSTEM CONFIGURATION → PRODUKTION & LOGISTIK

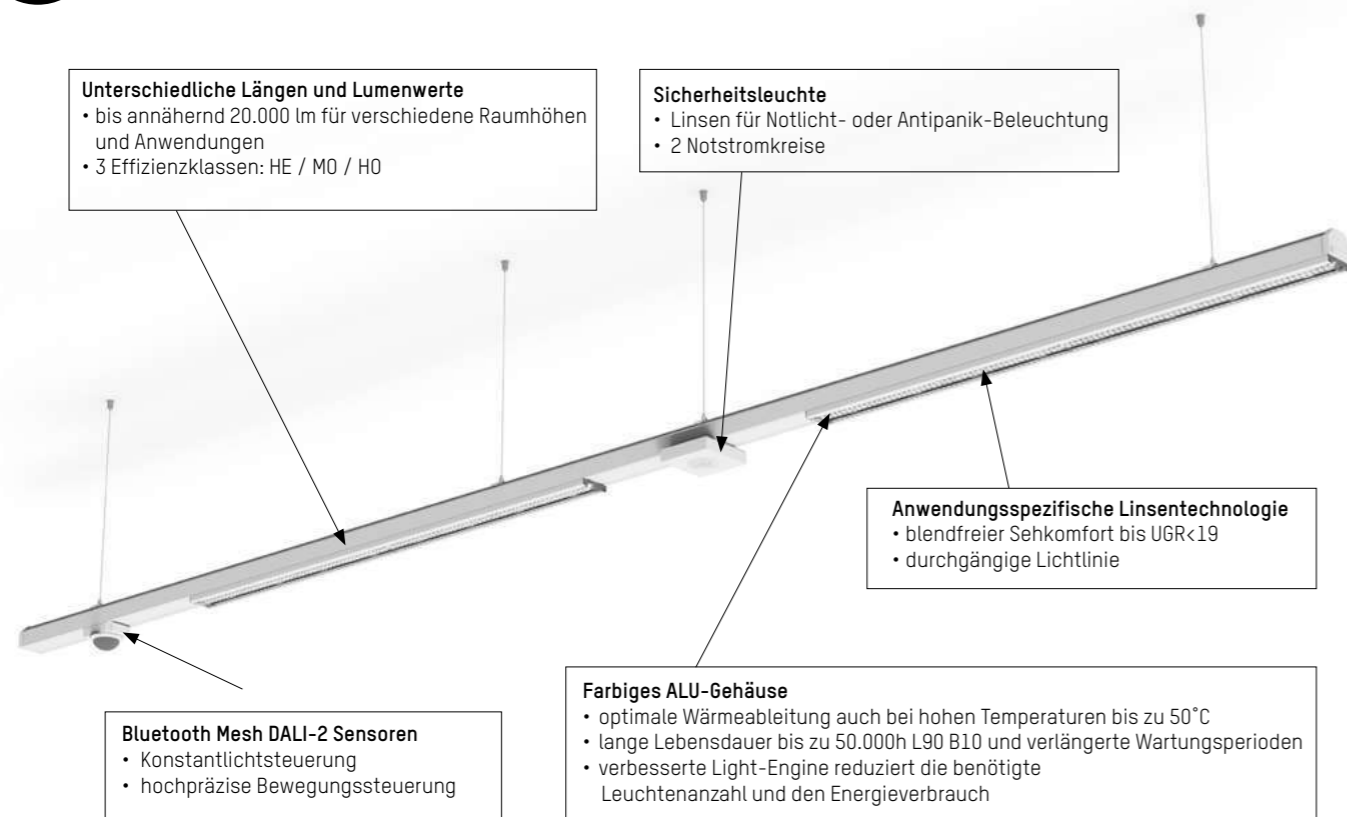

**Unterschiedliche Längen und Lumenwerte**  
 • bis annähernd 20.000 lm für verschiedene Raumhöhen und Anwendungen  
 • 3 Effizienzklassen: HE / MO / HO

**Sicherheitsleuchte**  
 • Linsen für Notlicht- oder Antipanik-Beleuchtung  
 • 2 Notstromkreise

**Anwendungsspezifische Linsentechnologie**  
 • blendfreier Sehkomfort bis UGR<19  
 • durchgängige Lichtlinie

**Bluetooth Mesh DALI-2 Sensoren**  
 • Konstantlichtsteuerung  
 • hochpräzise Bewegungssteuerung

**Farbiges ALU-Gehäuse**  
 • optimale Wärmeableitung auch bei hohen Temperaturen bis zu 50°C  
 • lange Lebensdauer bis zu 50.000h L90 B10 und verlängerte Wartungsperioden  
 • verbesserte Light-Engine reduziert die benötigte Leuchtenanzahl und den Energieverbrauch

SYSTEM CONFIGURATION → RETAIL

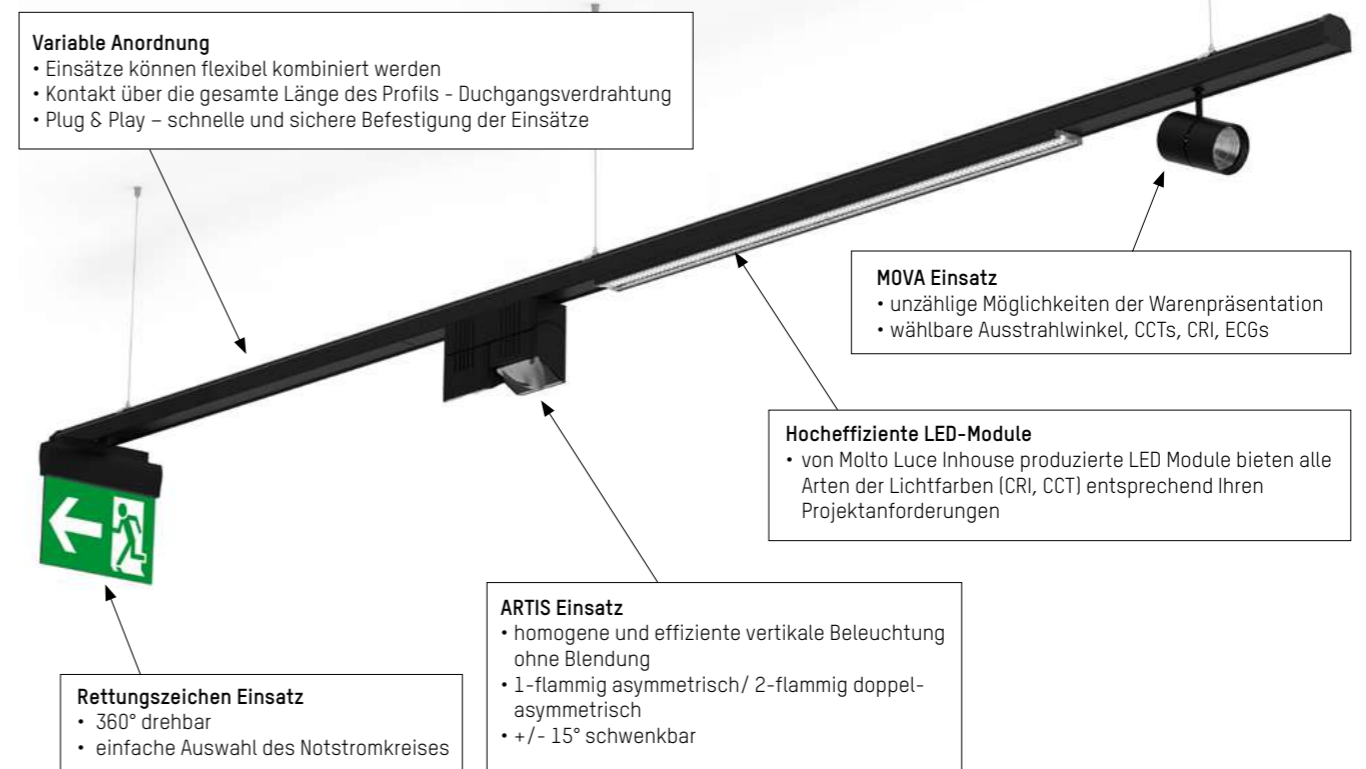

**Variable Anordnung**  
 • Einsätze können flexibel kombiniert werden  
 • Kontakt über die gesamte Länge des Profils - Duschungsverdrahtung  
 • Plug & Play - schnelle und sichere Befestigung der Einsätze

**MOVA Einsatz**  
 • unzählige Möglichkeiten der Warenpräsentation  
 • wählbare Ausstrahlwinkel, CCTs, CRI, ECGs

**Hocheffiziente LED-Module**  
 • von Molto Luce Inhouse produzierte LED Module bieten alle Arten der Lichtfarben (CRI, CCT) entsprechend Ihren Projektanforderungen

**ARTIS Einsatz**  
 • homogene und effiziente vertikale Beleuchtung ohne Blendung  
 • 1-flammig asymmetrisch/ 2-flammig doppel-asymmetrisch  
 • +/- 15° schwenkbar

**Rettungszeichen Einsatz**  
 • 360° drehbar  
 • einfache Auswahl des Notstromkreises

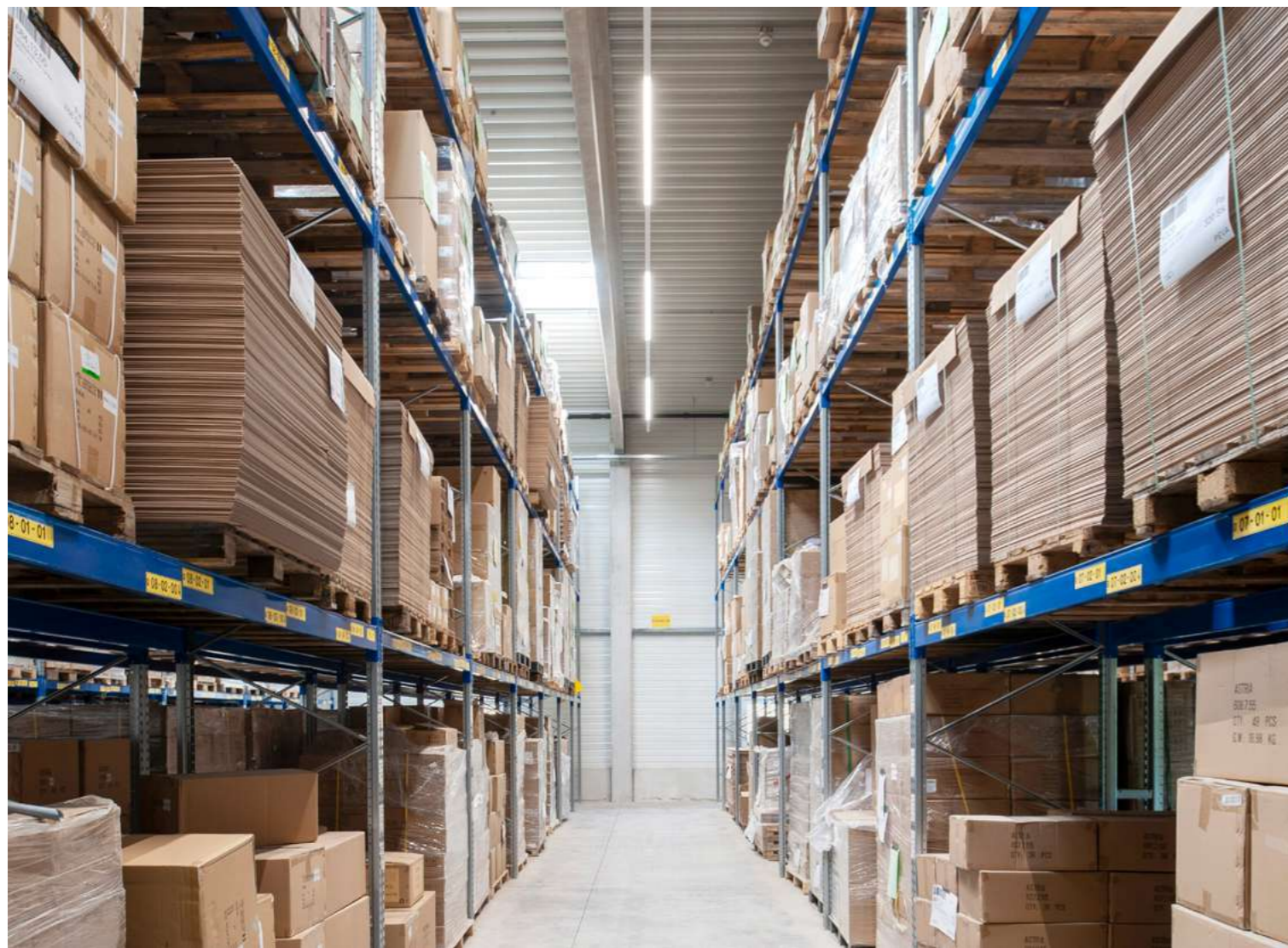

VERKABELUNGSBEISPIEL → PRODUKTION & LOGISTIK

Kombi 1 (7-polige Schiene)  
ON/OFF & Notlicht

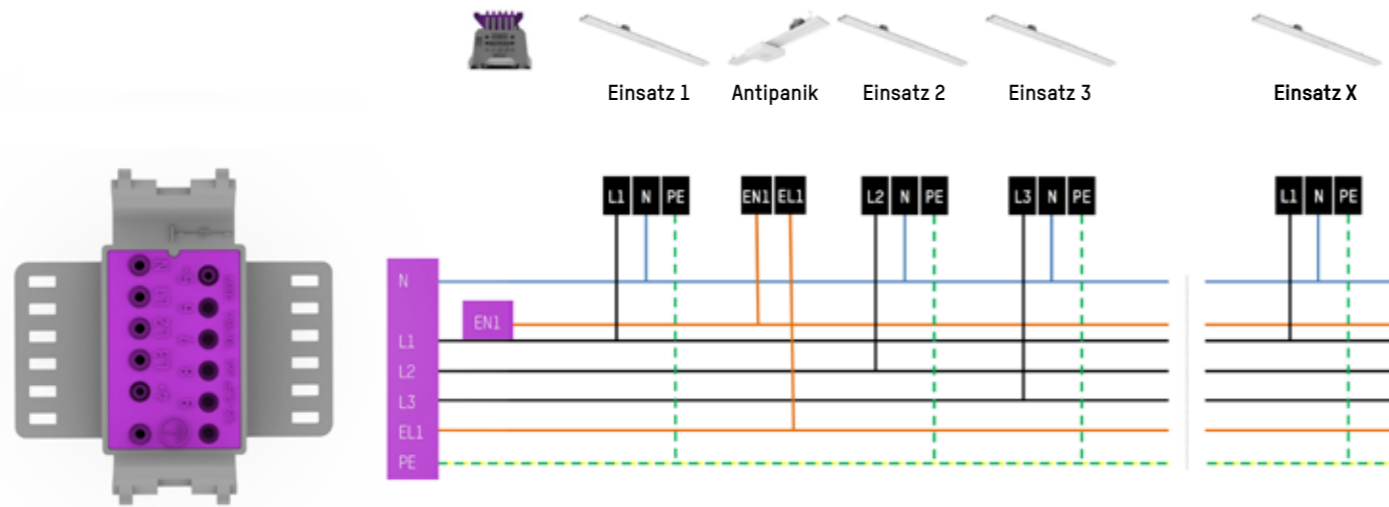

VERKABELUNGSBEISPIEL → PRODUKTION & LOGISTIK

Kombi 3 (11-polige Schiene)  
DALI-2 Licht - & Bewegungssteuerung  
+ 2 Kreise für Sicherheitsbeleuchtung

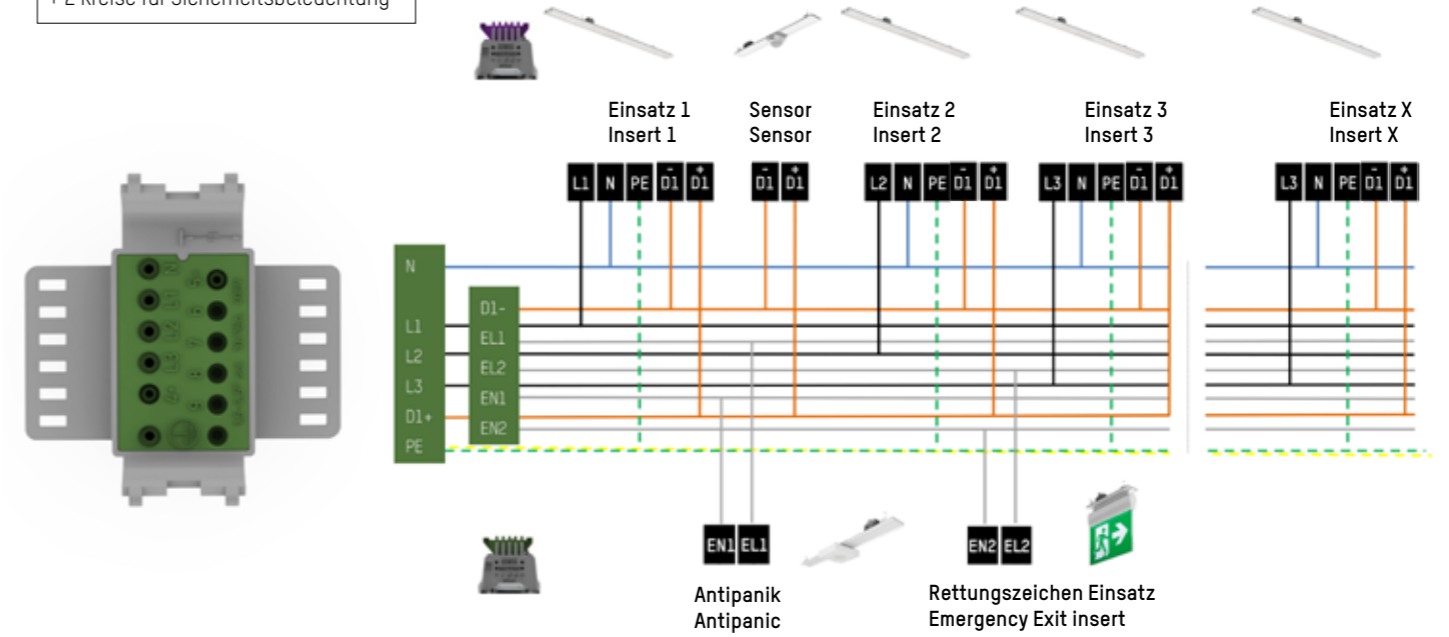

VERKABELUNGSBEISPIEL → PRODUKTION & LOGISTIK

Kombi 2 (7-polige Schiene)  
DALI-2 Licht - & Bewegungssteuerung

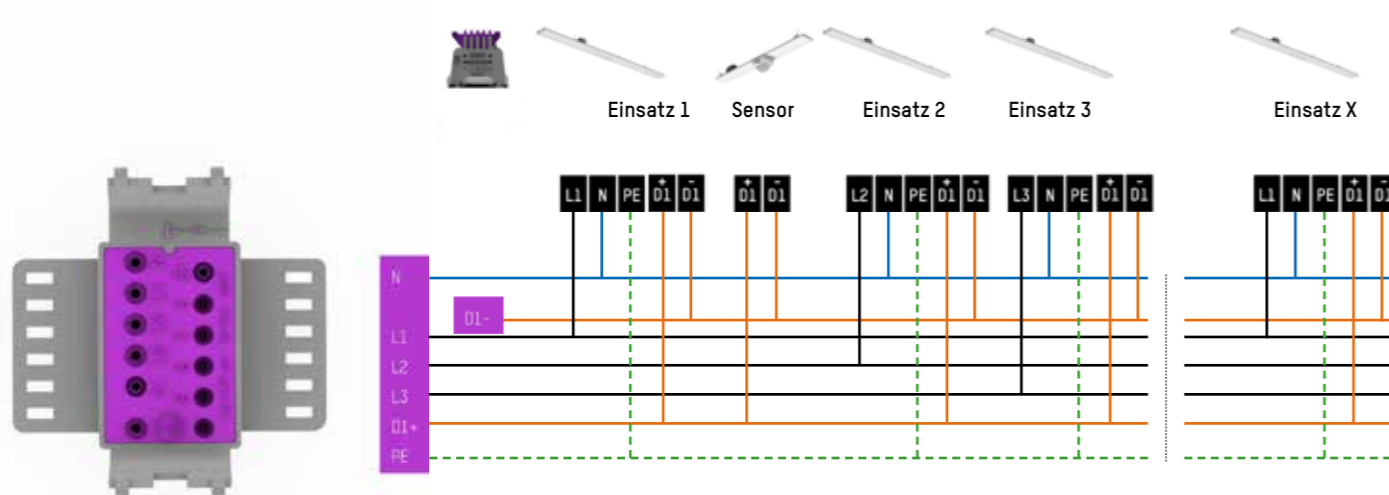

VERKABELUNGSBEISPIEL → RETAIL

Kombi 3 (11-polige Schiene)  
L1 - ON / OFF Lichteinsätze  
L2 - MOVA  
L3 - ARTIS  
+ 2 Kreise für Sicherheitsbeleuchtung

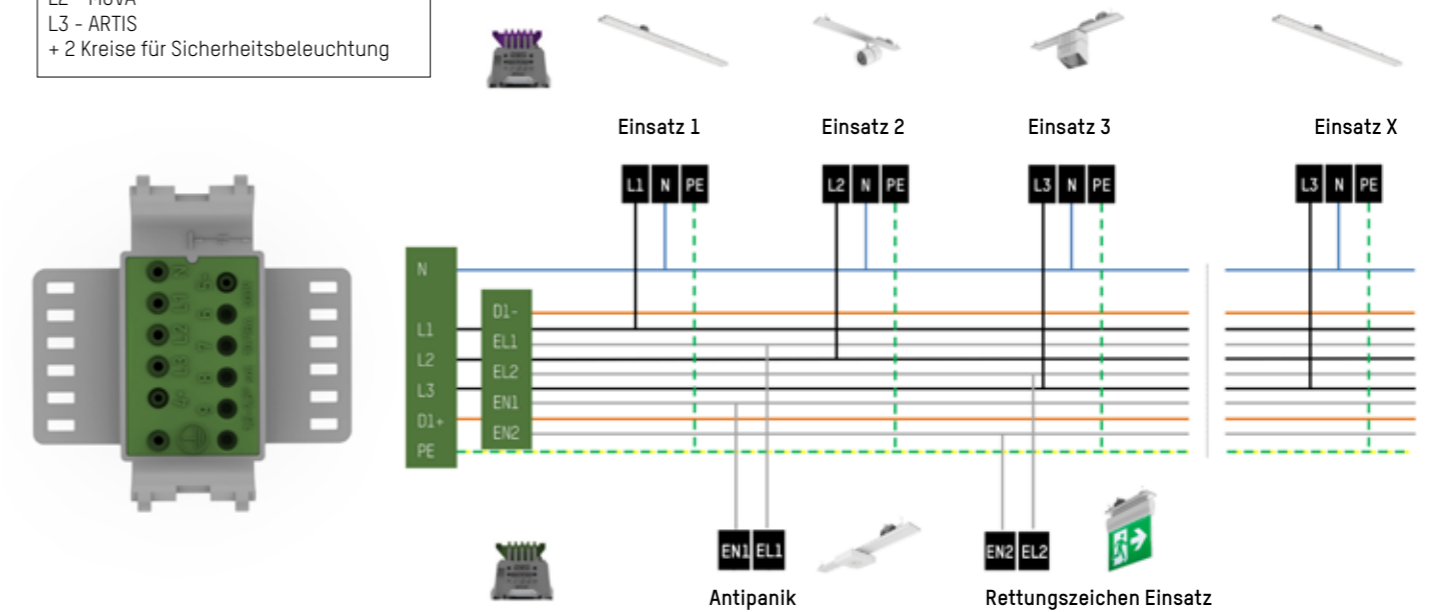

### EINZELTRAGSCHIENE SET

#### INFORMATION

7-polige Stromführung, verzinktes Stahlblech, Bestehend aus Tragschiene, 2 x Enddeckel, Einspeisung flexibel,  
**Achtung: nur in Weiß und Silber erhältlich**



L x B x H	POLIG	ART.NR.
1137 x 64 x 50	7	610-0401001000XX0
1696 x 64 x 50	7	610-0402001000XX0

### TRAGSCHIENE

#### INFORMATION

7- oder 11 polige Stromführung, verzinktes Stahlblech



L x B x H	POLIG	ART.NR.
1137 x 64 x 50	7	610-0201001000XX0
1696 x 64 x 50	7	610-0202001000XX0
2255 x 64 x 50	7	610-0203001000XX0
3392 x 64 x 50	7	610-0208001000XX0
4510 x 64 x 50	7	610-0204001000XX0
1137 x 64 x 50	11	610-0201002000XX0
1696 x 64 x 50	11	610-0202002000XX0
2255 x 64 x 50	11	610-0203002000XX0
3392 x 64 x 50	11	610-0208002000XX0
4510 x 64 x 50	11	610-0204002000XX0

### EINSPEISUNGSSET FLEXIBEL

#### INFORMATION

werkzeuglose Montage

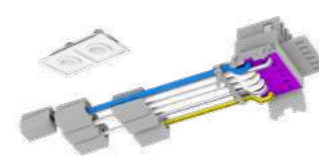

POLIG	ART.NR.
7	610-0101001000000
11	610-0101002000000

### EINSPEISUNGSSET STARR

#### INFORMATION

werkzeuglose Montage

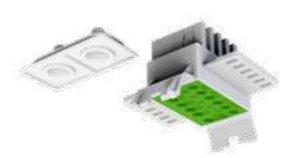

POLIG	ART.NR.
7	610-0102001000000
11	610-0102002000000

### MONTAGEHILFE FÜR EINSPEISUNGSSET

#### INFORMATION



ART.NR.
610-0007000000000

### ARTIKELNUMMER ERGÄNZEN

XX = FARBE

silber = 04

weiß = 05

schwarz = 06 **Achtung:** Nicht bei Einzeltragschienen-Set

### LINEARVERBINDER ELEKTRISCH

#### INFORMATION

innenliegend, inkl. Schienenverbinder



B x L	POLIG	ART.NR.
62 x 300	7	610-0002001000000
62 x 300	11	610-0002002000000

### MITTELEINSPEISUNG IP20

#### INFORMATION

werkzeuglose Montage, für max. 4 Stück Kabel mit 10-14 Durchmesser



B x L	POLIG	ART.NR.
64 x 562	7	610-0020001000XX0
64 x 562	11	610-0020002000XX0

### MITTELEINSPEISUNG IP54

#### INFORMATION

werkzeuglose Montage, für max. 4 Stück Kabel mit 10-14 Durchmesser



B x L	POLIG	ART.NR.
64 x 562	7	610-0021001000050
64 x 562	11	610-0021002000050

### L/T/X VERBINDER

#### INFORMATION

außen, Flexverbinder elektrisch separat ordern

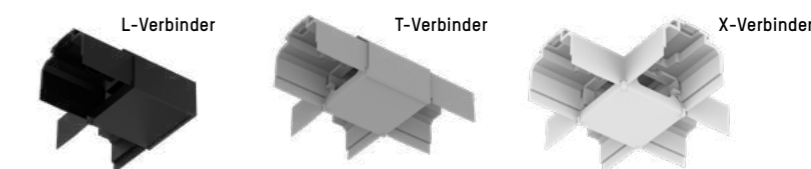

FLEXVERBINDER ORDERN STK.	VARIANTE	L x B	ART.NR.
1	L-VERBINDER	115 x 115	610-0009000000XX0
2	T-VERBINDER	165 x 115	610-0010000000XX0
3	X-VERBINDER	165 x 165	610-0011000000XX0

### FLEXVERBINDER ELEKTRISCH

#### INFORMATION

innenliegend, für T, L, X Verbinder

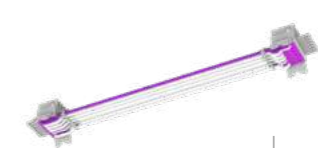

L	POLIG	ART.NR.
358	7	610-0012001000000
358	11	610-0012002000000

### ARTIKELNUMMER ERGÄNZEN



XX = FARBE



silber = 04

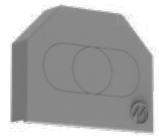

weiß = 05



schwarz = 06

ENDECKEL	INFORMATION	ART.NR.
 	Set 2 Stück	610-0001000000XX0

ENDECKEL IP54	INFORMATION	ART.NR.
 	Set 2 Stück PG 16	610-0017000000XX0



BLINDABDECKUNG PMMA	L	ART.NR.
 	1137	610-0231000000XX0
	1696	610-0237000000XX0
	2255	610-0232000000XX0
	4510	610-0233000000XX0

Endeckel Blindabdeckung IP54	INFORMATION	ART.NR.
 	Dichtung für Blindab- deckungsstoss Set 2 Stk.	610-0013000000050

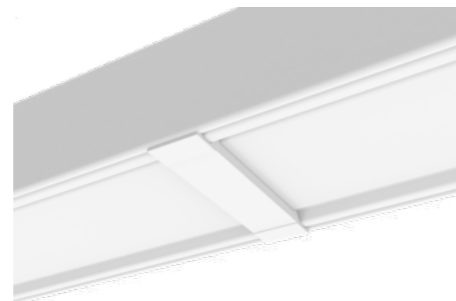

BLINDABDECKUNG METALL	L	ART.NR.
 	1137 weiss	610-0234000000050

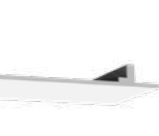
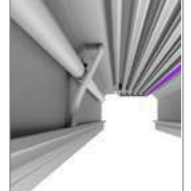

ENDKAPPE STROMFÜHRUNG	INFORMATION	ART.NR.
 	werkzeuglose Montage Set links + rechts	610-0015000000000

DICHTUNG SCHIENE IP54	INFORMATION	ART.NR.
 	Dichtung für Tragschiene Kunststoff	610-0008000000050

KABELHALTER INNEN	DETAIL	ART.NR.
 		610-0014000000000

KABELHALTER AUSSEN	DETAIL	ART.NR.
 		610-0016000000000



#### ARTIKELNUMMER ERGÄNZEN

XX = FARBE

silber = 04

weiß = 05



schwarz = 06

SEIL-BEFESTIGUNG	B x H	ART.NR.
 	42 x 15	610-0004000000000

SEIL-BEFESTIGUNG HOCH	B x H	ART.NR.
 	42 x 35	610-0005000000000
für Installationsrohr 25mm		

KETTENBEFESTIGUNG	B x H	ART.NR.
 	42 x 15	610-0006000000000

KETTENBEFESTIGUNG HOCH	B x H	ART.NR.
 	42 x 35	610-0019000000000
für Installationsrohr 25mm		

DECKENBEFESTIGUNG	B x H	ART.NR.
 	42 x 19	610-0003000000000

CADDY CLIP ABHÄNGUNG	B x H	ART.NR.
 	34 x 41	610-0018000000000
für Deckensysteme 24 - 26mm		

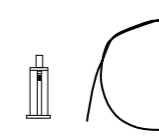
STAHLSEIL	Ø x L	ART.NR.
 	1,5 x 3000	610-0022000000000
inkl. Seilstopper beliebig kürzbar		

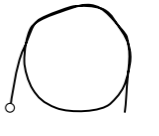
STAHLSEIL MIT ÖSE	Ø x L	ART.NR.
 	1,5 x 1500	610-0025000000000
	1,5 x 3000	610-0026000000000
	1,5 x 6000	610-0027000000000
beliebig kürzbar		

KETTE	B x H	ART.NR.
 	31 x 10	835-9926194
Tragkraft: max. 30kg Ø 2,2mm / Meterware		

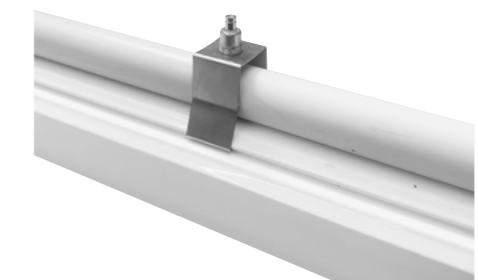

Anwendungsbeispiel mit  
Installationsrohr 25mm



### TRAGSCHIENE

INFORMATION	L x B x H	ART.NR.
Leermodul ohne Stromführung, verzinktes Stahlblech	4510 x 64 x 50	610-0205000000XX0



### LINEARVERBINDER MECHANISCH

INFORMATION	L x B x H	ART.NR.
innenliegend	300 x 62 x 50	610-0023000000000



### BLINDABDECKUNG

INFORMATION	L x B x H	ART.NR.
Blindabdeckung aus Kunststoff	1137 x 58 x 15	610-0231000000XX0
	1696 x 58 x 15	610-0237000000XX0
	2255 x 58 x 15	610-0232000000XX0
	4510 x 58 x 15	610-0233000000XX0

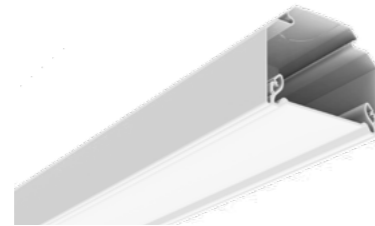

### BLINDABDECKUNG

INFORMATION	L x B x H	FARBE	ART.NR.
Blindabdeckung aus Metall	1137 x 58 x 15	weiß	610-0234000000050

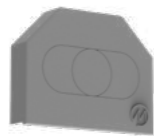

### ENDECKEL

INFORMATION	ART.NR.
Set 2 Stück	610-0001000000XX0



### LEITUNGSHALTER INNEN

INFORMATION	ART.NR.
aus Metall	610-0029000000000

### ARTIKELNUMMER ERGÄNZEN

XX = FARBE

- silber = 04
- weiß = 05
- schwarz = 06

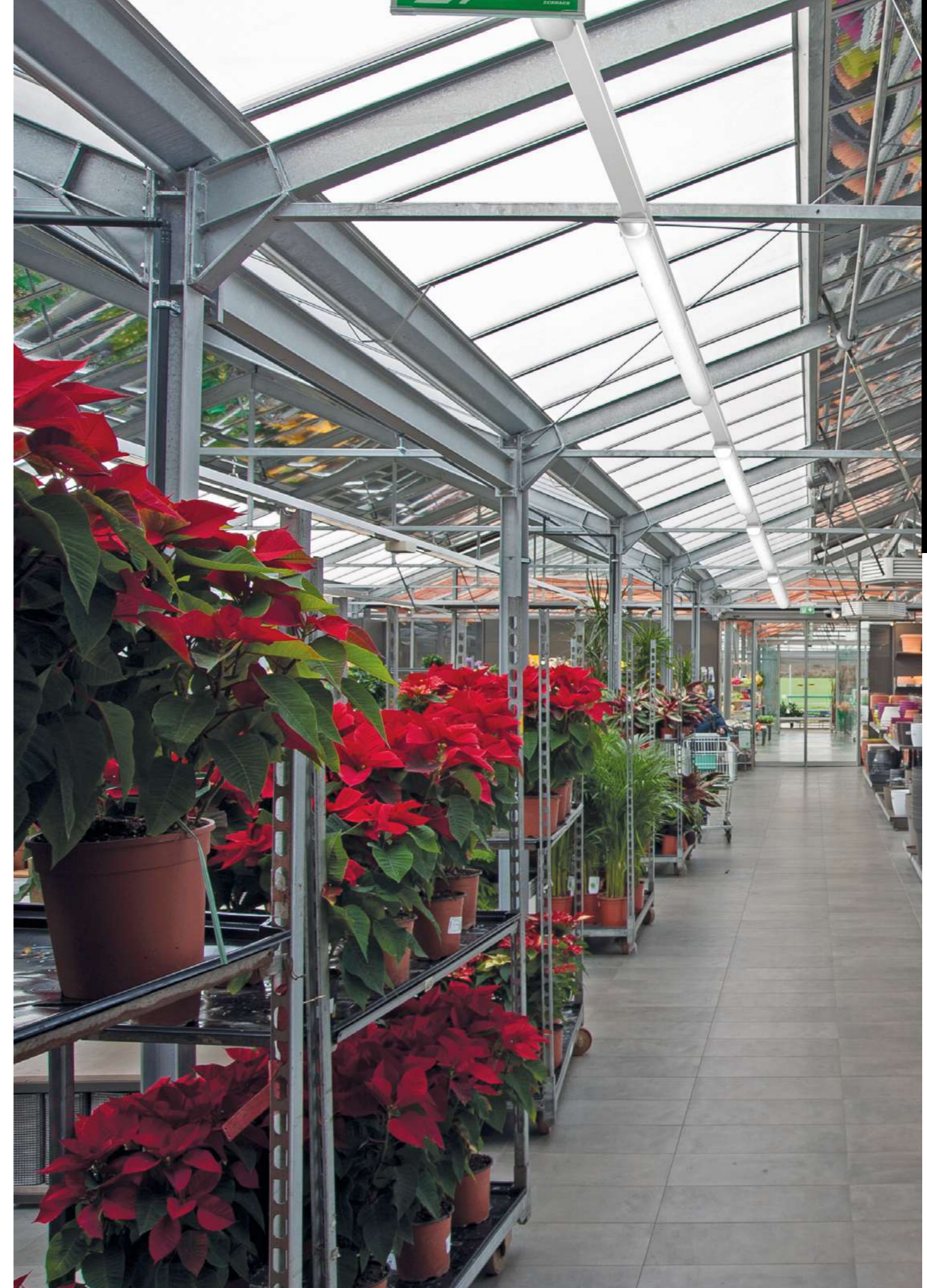

Bildretusche, Foto: Shutterstock, Produkt: 30NE BASIC



### 3ONE BASIC PMMA COVER

INFORMATION	LEISTUNG	LUMEN	LF	L x B x H	AUSFÜHRUNG	VERDR.	ART.NR.
Feuchtraumleuchte, Gehäuse aus GRP (glas-verstärktes Polyester) mit PU-Abdichtung, inkl. Konverter, 1:1 Austausch bestehender T8 Leuchten, lange Lebensdauer bis zu 50.000h L80 B10, einfache & schnelle Installation, einzigartige Lichtdurchlässigkeit (bis zu 93 %)	SYS 25W	3400	4000K	1277 x 90 x 95	SCHALTBAR	OHNE	175-0032034131440
	SYS 38W	5100	4000K	1277 x 90 x 95	SCHALTBAR	OHNE	175-0032051131440
	SYS 30W	4200	4000K	1577 x 90 x 95	SCHALTBAR	OHNE	175-0035042131440
	SYS 50W	7000	4000K	1577 x 90 x 95	SCHALTBAR	OHNE	175-0035070131440
	SYS 50W	7000	6500K	1577 x 90 x 95	SCHALTBAR	OHNE	175-0035070131640
	SYS 30/37/44/51W	4500/5500/6400/7000	3000K	1577 x 90 x 95	MULTI-LUMEN	OHNE	175-0035070131341

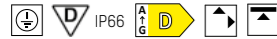

### 3ONE BASIC PC COVER

INFORMATION	LEISTUNG	LUMEN	LF	L x B x H	AUSFÜHRUNG	VERDR.	ART.NR.
Feuchtraumleuchte, Gehäuse aus GRP (glas-verstärktes Polyester) mit PU-Abdichtung, inkl. Konverter, 1:1 Austausch bestehender T8 Leuchten, lange Lebensdauer bis zu 50.000h L80 B10, einfache & schnelle Installation, einzigartige Lichtdurchlässigkeit (bis zu 93 %)	SYS 25W	3200	4000K	1277 x 90 x 95	SCHALTBAR	5 x 1,5mm	175-0032332231440
	SYS 38W	4900	4000K	1277 x 90 x 95	SCHALTBAR	OHNE	175-0032049231440
	SYS 38W	4900	4000K	1277 x 90 x 95	SCHALTBAR	5 x 1,5mm	175-0032349231440
	SYS 30W	4000	4000K	1577 x 90 x 95	SCHALTBAR	5 x 1,5mm	175-0035340231440
	SYS 50W	6600	4000K	1577 x 90 x 95	SCHALTBAR	OHNE	175-0035066231440
	SYS 50W	6600	4000K	1577 x 90 x 95	SCHALTBAR	5 x 1,5mm	175-0035366231440
	SYS 30/37/44/51W	4300/5200/6100/6650	3000K	1577 x 90 x 95	MULTI-LUMEN	5 x 1,5mm	175-0035366231341

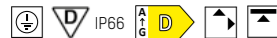

### 3ONE EM PC COVER

INFORMATION	LEISTUNG	LUMEN	LF	L x B x H	AUSFÜHRUNG	VERDR.	ART.NR.
Feuchtraumleuchte, Gehäuse aus GRP (glasverstärktes Polyester), PC-Abdeckung mit hoher Stoßfestigkeit IK08, inkl. Konverter, Notlichtlösung mit Einzelbatteriesystem, Nennbetriebsdauer: 3h, 420lm im Notbetrieb, einzigartige Lichtdurchlässigkeit (bis zu 93 %)	SYS 22W	3200	4000K	1277 x 90 x 95	SCHALTBAR	OHNE	175-036203223144e
	SYS 31W	4600	4000K	1277 x 90 x 95	SCHALTBAR	OHNE	175-036204623144e
	SYS 27W	4000	4000K	1577 x 90 x 95	SCHALTBAR	OHNE	175-036504023144e
	SYS 41W	6200	4000K	1577 x 90 x 95	SCHALTBAR	OHNE	175-036506223144e



#### ANDERE VARIANTEN UND BESTELLDDETAILS AUF ANFRAGE

VERDRAHTUNG	LICHTFARBE	DIMMBAR
Ohne Verdrahtung Verdrahtung 3x 1,5 mm Verdrahtung 5x 1,5 mm	andere Lichtfarben auf Anfrage	schaltbar schaltbar MULTI-LUMEN DALI dimm.

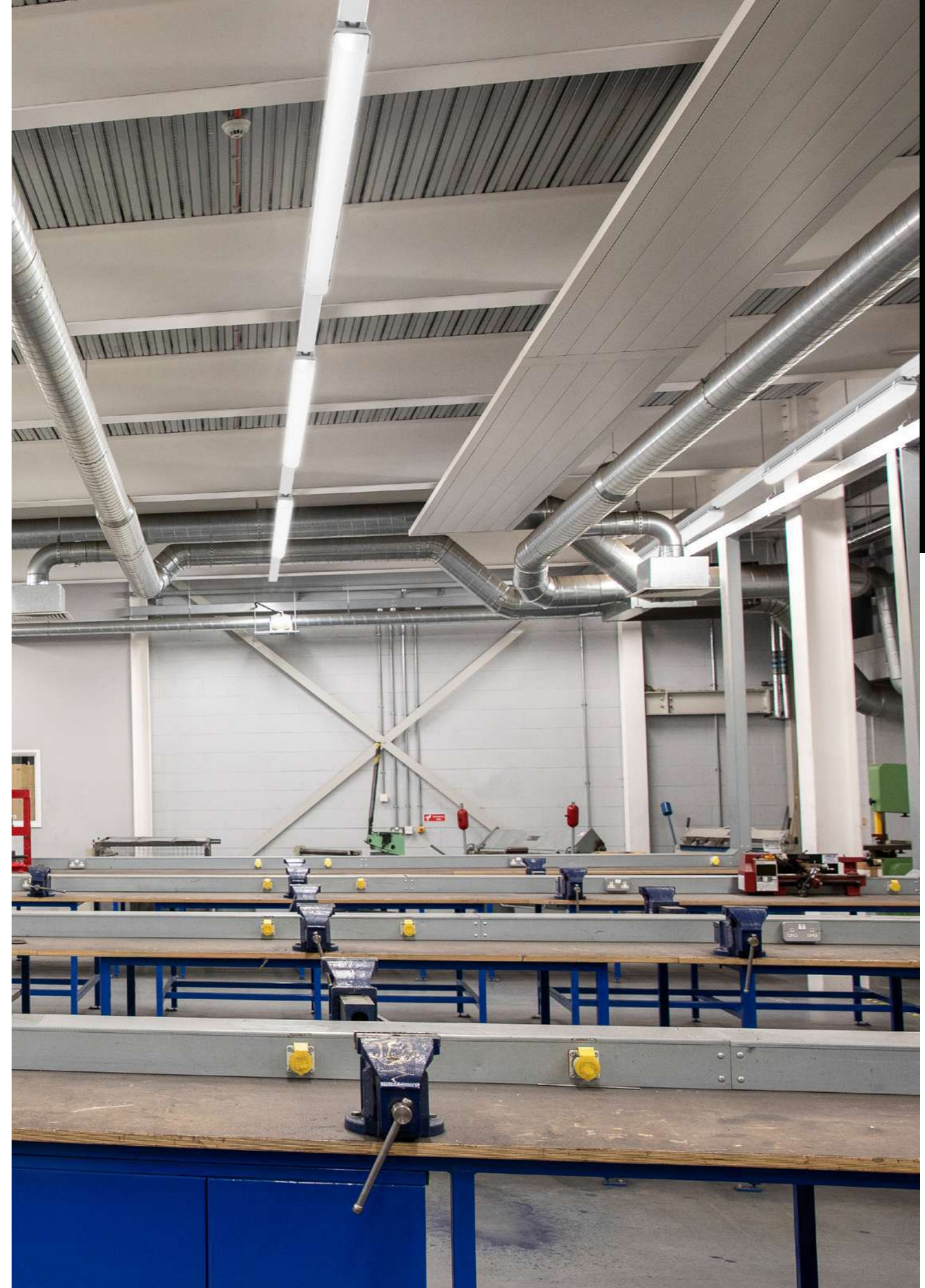





### 3ONE PMMA COVER



INFORMATION	LEISTUNG	LUMEN	LF	L x B x H	AUSFÜHRUNG	VERDR.	ART.NR.
Feuchtraumleuchte, Gehäuse aus GRP (glasverstärktes Polyester) mit Silikondichtung, inkl. Konverter, z.B. in der Holzindustrie (Tischlerei), viele verschiedene Leuchtenvarianten (bis zu 12700lm), hocheffiziente LED Module (bis zu 164 lm/W), lange Lebensdauer bis zu 50.000 L80 B10 in Umgebungstemperaturen von -20°C bis zu +40°C.	SYS 31W	4800	4000K	1277 x 90 x 95	SCHALTBAR	OHNE	175-0162048131440
	SYS 32/27/23/19W	5200/4500/3700/3000	4000K	1277 x 90 x 95	MULTI-LUMEN	OHNE	175-0162052131441
	SYS 27W	4200	4000K	1577 x 90 x 95	SCHALTBAR	OHNE	175-0165042131440
	SYS 41W	6500	4000K	1577 x 90 x 95	SCHALTBAR	OHNE	175-0165065131440
	SYS 41W	6500	4000K	1577 x 90 x 95	DALI DIMM	OHNE	175-016506513144d
	SYS 65W	8800	4000K	1577 x 90 x 95	SCHALTBAR	OHNE	175-0165087131440
	SYS 65W	8800	4000K	1577 x 90 x 95	SCHALTBAR	5 x 2,5mm	175-0165487131440
	SYS 73W	10200	4000K	1577 x 116 x 99	SCHALTBAR	OHNE	175-0165010131440
	SYS 83W	12700	4000K	1577 x 116 x 99	SCHALTBAR	OHNE	175-0165012131440
	SYS 44/38/32/25W	7200/6200/5200/4100	4000K	1577 x 90 x 95	MULTI-LUMEN	OHNE	175-0165072131441
	SYS 44/38/32/25W	7200/6200/5200/4100	4000K	1577 x 90 x 95	MULTI-LUMEN	5 x 2,5mm	175-0165472131441



### 3ONE PC COVER



INFORMATION	LEISTUNG	LUMEN	LF	L x B x H	AUSFÜHRUNG	VERDR.	ART.NR.
Feuchtraumleuchte, Gehäuse aus GRP (glasverstärktes Polyester) & PC-Abdeckung mit hoher Stoßfestigkeit IK08 (Parkhäuser), inkl. Konverter, entspricht den Anforderungen internationaler Standards der Lebensmittelindustrie, einzigartige Lichtdurchlässigkeit (bis zu 93 %)	SYS 27W	4000	4000K	1577 x 90 x 95	SCHALTBAR	OHNE	175-0165040231440
	SYS 41W	6200	4000K	1577 x 90 x 95	SCHALTBAR	OHNE	175-0165082231440
	SYS 41W	6200	4000K	1577 x 90 x 95	SCHALTBAR	5 x 2,5mm	175-0165462231440
	SYS 65W	8400	4000K	1577 x 90 x 95	SCHALTBAR	OHNE	175-0165082231440
	SYS 65W	8400	4000K	1577 x 90 x 95	SCHALTBAR	5 x 2,5mm	175-0165482231440
	SYS 73W	9600	4000K	1577 x 116 x 99	SCHALTBAR	OHNE	175-0165096231440
	SYS 83W	12000	4000K	1577 x 116 x 99	SCHALTBAR	OHNE	175-0165012231440
	SYS 44/38/32/25W	6700/5700/4800/3800	4000K	1577 x 90 x 95	MULTI-LUMEN	OHNE	175-0165067231441
	SYS 44/38/32/25W	6700/5700/4800/3800	4000K	1577 x 90 x 95	MULTI-LUMEN	5 x 2,5mm	175-0165467231441

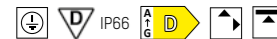

### 3ONE OUTDOOR PMMA COVER



INFORMATION	LEISTUNG	LUMEN	LF	L x B x H	AUSFÜHRUNG	VERDR.	ART.NR.
Feuchtraumleuchte, Gehäuse aus GRP (glasverstärktes Polyester) mit Silikondichtung, inkl. Konverter, für Außenbereiche (z.B. Laderampe), hohe Witterungsbeständigkeit, PMMA-Diffuser (UV-stabil), entlüftete Kabelverschraubung zur Vermeidung von Feuchtigkeitsstau	SYS 31W	4800	4000K	1277 x 90 x 95	SCHALTBAR	OHNE	175-0662048131440
	SYS 27W	4200	4000K	1577 x 90 x 95	SCHALTBAR	OHNE	175-0665042131440

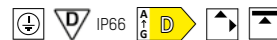

#### ANDERE VARIANTEN UND BESTELLDDETAILS AUF ANFRAGE

VERDRAHTUNG	LICHTFARBE	DIMMBAR
Ohne Verdrahtung	andere Lichtfarben auf Anfrage	schaltbar
Verdrahtung 3x 2,5 mm		schaltbar MULTI-LUMEN
Verdrahtung 5x 2,5 mm		DALI dimm.

# MOLTO LUCE

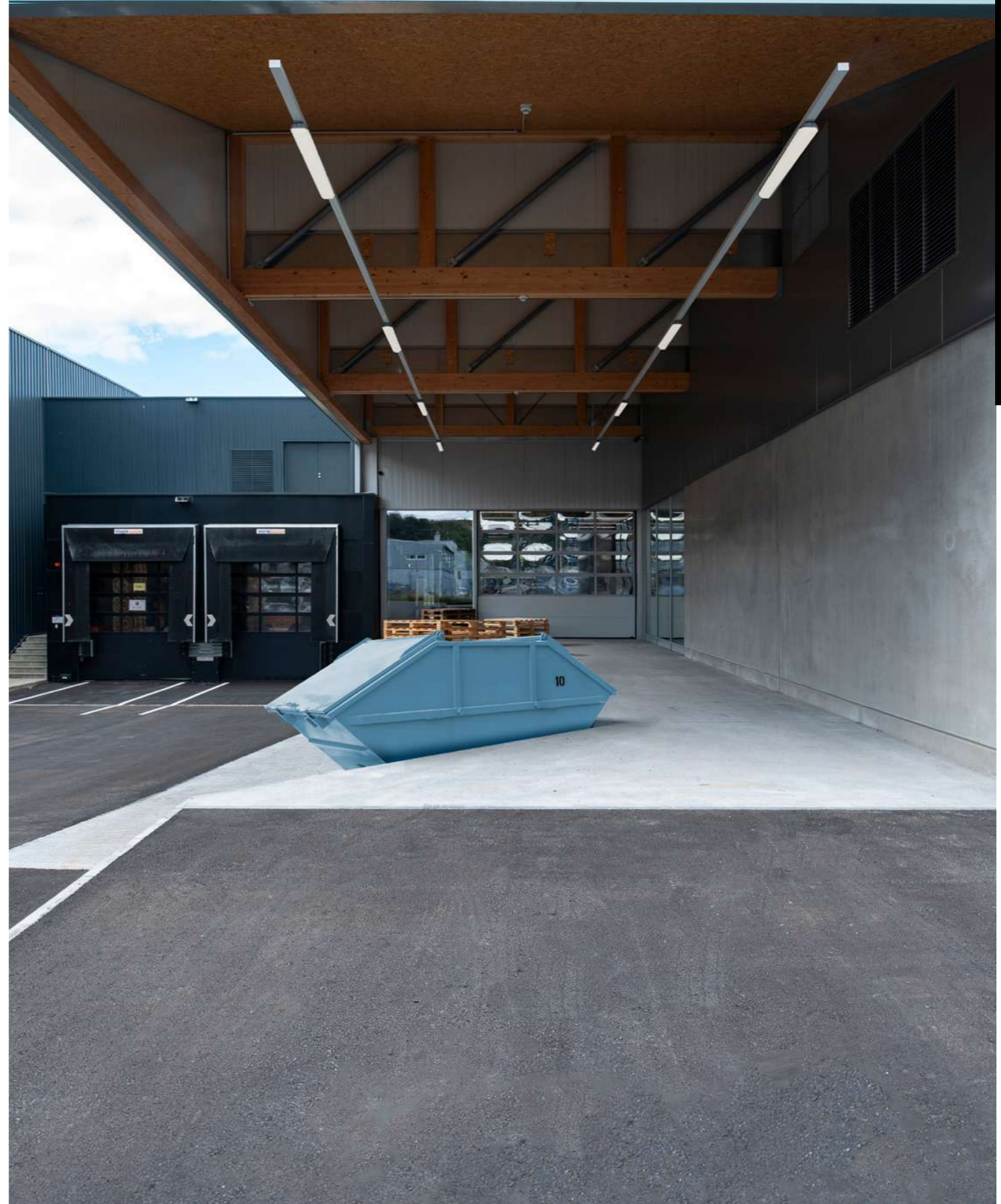

Bildretusche, Foto: Molto Luce, Produkt: 3ONE OUTDOOR

# SPEZIAL-ANWENDUNGEN

## 3ONE SKII PMMA COVER



### INFORMATION

Feuchtraumleuchte, Gehäuse aus GRP (glasverstärktes Polyester) mit Silikondichtung (silicon-based endless foam), inkl. Konverter, CRI>80

**Typische Anwendungen:** Einfache sowie feuergefährdete Betriebsstätten, Bereiche mit erhöhten Sicherheitsstandards, hoher Verschmutzungsgrad

**Vorteile:** Schutzklasse II, einzigartige Lichtdurchlässigkeit (bis zu 93 %)



LEISTUNG	LUMEN	LF	VERDRAHTUNG	DIMM	L x B x H	ART.NR.
SYS 31W	4500	4000K	OHNE	ON/OFF	1277 x 90 x 95	175-0262045131440
SYS 38W	5400	4000K	OHNE	ON/OFF	1577 x 90 x 95	175-0265054131440
SYS 49W	6900	4000K	OHNE	ON/OFF	1577 x 116 x 99	175-0265069131440



## 3ONE SKII PC COVER



### INFORMATION

Feuchtraumleuchte, Gehäuse aus GRP (glasverstärktes Polyester) mit Silikondichtung (silicon-based endless foam), inkl. Konverter, CRI>80

**Typische Anwendungen:** Einfache sowie feuergefährdete Betriebsstätten, Bereiche mit erhöhten Sicherheitsstandards, hoher Verschmutzungsgrad

**Vorteile:** Schutzklasse II, einzigartige Lichtdurchlässigkeit (bis zu 93 %)



LEISTUNG	LUMEN	LF	VERDRAHTUNG	DIMM	L x B x H	ART.NR.
SYS 31W	4300	4000K	OHNE	ON/OFF	1277 x 90 x 95	175-0262043231440
SYS 38W	5200	4000K	OHNE	ON/OFF	1577 x 90 x 95	175-0265052231440
SYS 49W	6500	4000K	OHNE	ON/OFF	1577 x 116 x 99	175-0235065231440



## 3ONE H&L PC COVER



### INFORMATION

Feuchtraumleuchte, Gehäuse aus GRP (glasverstärktes Polyester) mit Silikondichtung (silicon-based endless foam), inkl. Konverter, CRI>80

**Typische Anwendungen:** Extreme Temperaturen (plus & minus), hohe Feuchtigkeit & Nässe (z.B. Kühllager)

**Vorteile:** Hohe Temperaturbeständigkeit (-30°C bis +55°C) bei voller Lebensdauer, entlüftete Kabelverschraubung zur Vermeidung von Feuchtigkeitsstau im Inneren der Leuchte, entspricht den Anforderungen internationaler Standards der Lebensmittelindustrie



LEISTUNG	LUMEN	LF	VERDRAHTUNG	DIMM	L x B x H	ART.NR.
SYS 32W	4696	4000K	OHNE	ON/OFF	1277 x 90 x 95	175-0462046231440
SYS 59W	8100	4000K	OHNE	ON/OFF	1277 x 116 x 95	175-0462081231440
SYS 40W	6107	4000K	OHNE	ON/OFF	1577 x 90 x 95	175-0465062231440
SYS 73W	10200	4000K	OHNE	ON/OFF	1577 x 116 x 99	175-0465099231440



## 3ONE EXTREME PMMA COVER



### INFORMATION

Feuchtraumleuchte, Gehäuse aus GRP (glasverstärktes Polyester), inkl. Konverter, CRI>80

**Typische Anwendungen:** Spezielle Industrie Bereiche mit erhöhter Anforderung an die chemische Beständigkeit, Nutztierhaltung (nicht für Geflügelhaltung geeignet), Lagerbereiche

**Vorteile:** Höhere chemische Beständigkeit, Ammoniakbeständig, speziell geschützte EVG's & Light Engine



LEISTUNG	LUMEN	LF	VERDRAHTUNG	DIMM	L x B x H	ART.NR.
SYS 23W	3800	4000K	OHNE	ON/OFF	1277 x 90 x 95	175-0562038131440
SYS 23W	3800	4000K	5x 2,5	ON/OFF	1277 x 90 x 95	175-0562438131440
SYS 33W	5000	4000K	OHNE	ON/OFF	1577 x 90 x 95	175-0565050131440
SYS 33W	5000	4000K	5x 2,5	ON/OFF	1577 x 90 x 95	175-0565450131440
SYS 43W	6600	4000K	OHNE	ON/OFF	1577 x 116 x 99	175-0565066131440
SYS 43W	6600	4000K	5x 2,5	ON/OFF	1577 x 116 x 99	175-0565466131440



ANDERE VARIANTEN UND BESTELLDDETAILS AUF ANFRAGE

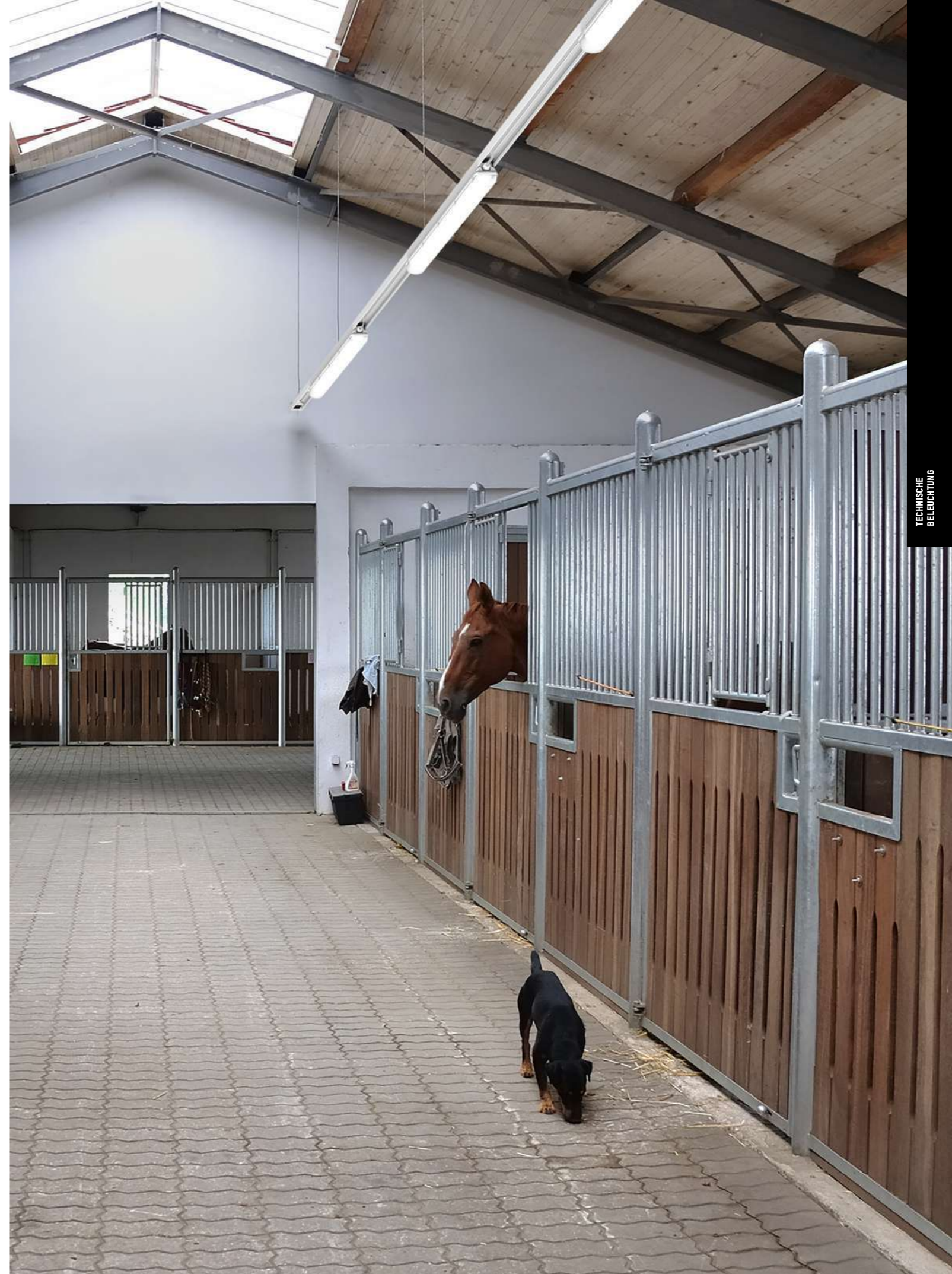

Bildretusche, Foto: Molto Luce, Produkt: 3ONE EXTREME



### TI60

INFORMATION	LEISTUNG	LUMEN	LUMEN/W	KELVIN	L x B x H	VERDRAHTUNG	ART.NR.
Feuchtraumleuchte aus Polycarbonat inkl. Konverter, für kleine Neben- & Lagerräume, Garagen & Gänge, 1:1 Austausch bestehender T8 Leuchten, einfache & schnelle Installation, werkzeugloser Einschuss über Auszugswanne, robuster PC (Polycarbonat) Gehäuse (IP66) mit hoher Stoßfestigkeit	SYS 25W	3250	128	4000	1192 x 75 x 75	3 x 1,5 mm	175-0732132231440
	SYS 38W	4900	128	4000	1192 x 75 x 75	ohne	175-0732049231440
	SYS 38W	4900	128	4000	1192 x 75 x 75	3 x 1,5 mm	175-0732149231440
	SYS 30W	4000	133	4000	1492 x 75 x 75	ohne	175-0735040231440
	SYS 30W	4000	133	4000	1492 x 75 x 75	3 x 1,5 mm	175-0735140231440
	SYS 50W	6500	130	4000	1492 x 75 x 75	ohne	175-0735065231440
SYS 50W	6500	130	4000	1492 x 75 x 75	3 x 1,5 mm	175-0735165231440	



HAKEN FÜR ABHÄNGUNGEN	INFORMATION	ART.NR.
	Aufpreis für einen Hakensatz zum Aufhängen. Ein Satz enthält 2 Haken.	175-073

### ANDERE VARIANTEN UND BESTELLDDETAILS AUF ANFRAGE

VERDRAHTUNG	LICHTFARBE	DIMMBAR	SCHUTZART
Ohne Verdrahtung	andere Lichtfarben auf Anfrage	schaltbar	IP66
Verdrahtung 3x 1,5 mm		DALI dimm.	
Verdrahtung 5x 1,5 mm			



INFORMATION	LEISTUNG	LUMEN	CRI>	KELVIN	L x B x H	FARBE	ART.NR.
Aufbauleuchte, Stahlblech, weiß lackiert, mit opaler Abdeckung, Endkappen aus Kunststoff, weiß, inkl. Konverter	SYS 20W	2500	80	3000	630 x 110 x 60	weiß	757-2100
	SYS 20W	2500	80	4000	630 x 110 x 60	weiß	757-2101
	SYS 34W	4200	80	3000	630 x 110 x 60	weiß	757-2102
	SYS 34W	4200	80	4000	630 x 110 x 60	weiß	757-2103
	SYS 18W	2600	80	3000	1210 x 110 x 60	weiß	757-2104
	SYS 18W	2600	80	4000	1210 x 110 x 60	weiß	757-2105
	SYS 36W	5100	80	3000	1210 x 110 x 60	weiß	757-2106
	SYS 36W	5100	80	4000	1210 x 110 x 60	weiß	757-2107
	SYS 47W	6900	80	3000	1500 x 110 x 60	weiß	757-2108
	SYS 47W	6900	80	4000	1500 x 110 x 60	weiß	757-2109
	SYS 58W	8200	80	3000	1500 x 110 x 60	weiß	757-2110
	SYS 58W	8200	80	4000	1500 x 110 x 60	weiß	757-2111

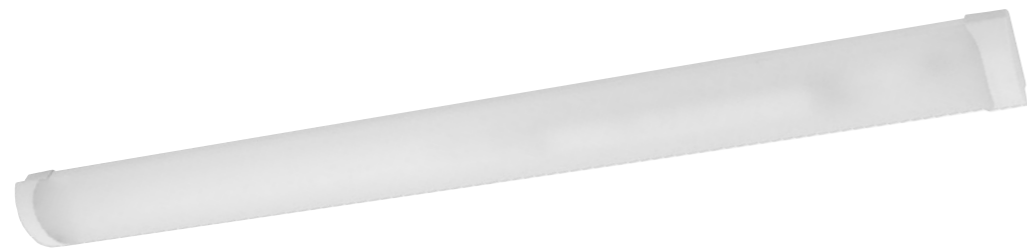
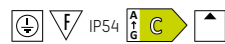

Bildretusche, Foto: Shutterstock, Produkt: TI60

**Verschiedene Leistungen bis ~ 21.000/30.000 lm für unterschiedliche Raumhöhen & Anwendungen**

- hohe Effizienz bis zu 160lm/W
- verschiedene Vorschaltgeräte verfügbar: ON/OFF (1-10V Dimmung), DALI-2
- DALI-2 Betriebsgerät mit Bus Power Supply Speicherbank, Energie Reporting Diagnose & Wartung
- Bei Wartung einfacher Austausch der EVG's



**TUNE Sensoren – Bluetooth Mesh DALI-2-Sensoren**

- Konstantlichtregelung
- hochpräzise Bewegungsüberwachung
- kreisrunde 360° oder rechteckige Erfassungsbereiche
- Drathlose Kommunikation

**Robustes Aluminiumgehäuse IP 66**

- zwei verschiedene Größen (280/360mm)
- lange Lebensdauer 70.000h L80 B10
- diverses Zubehör
- Halterung für Wand-/Deckenmontage
- ballwurfsicher geprüft (ballwurfsicheres Gitter)
- Konstruktion nach thermischen Anforderungen entwickelt für Einsatz bis zu 50°C Umgebungstemperatur
- einfache & schnelle Montage - Einpunktaufhängung & elektrischer Anschluss (Steckverbindung)
- höhere chemische Beständigkeit
- sehr gute mechanische Stabilität

**Einzigartige Wabenoptik**

- hervorragender Sehkomfort (UGR bis <22/25)
- hohe Schlagfestigkeit IK10 (PC), IK08 (Glas)
- PC-Refraktor (nur 280 mm)



# TUNE

- OPTIMALES LICHTNIVEAU FÜR PROFESSIONELLE EINSATZMÖGLICHKEITEN**  
→ Exzellenter Blendschutz und Sehkomfort – auch für schwerste Industrieanwendungen
- ZUKUNFTSSICHER**  
→ Lange Lebensdauer bei hoher Umgebungstemperatur von 45°C mit 30.000lm
- INDIVIDUALISIERBAR**  
→ Viele verschiedene Lumenoutputs für kompromisslosen Einsatz
- Licht 4.0**  
→ neue Sensorenfamilie für hohe Energieeinsparung und CO<sup>2</sup> Reduktion

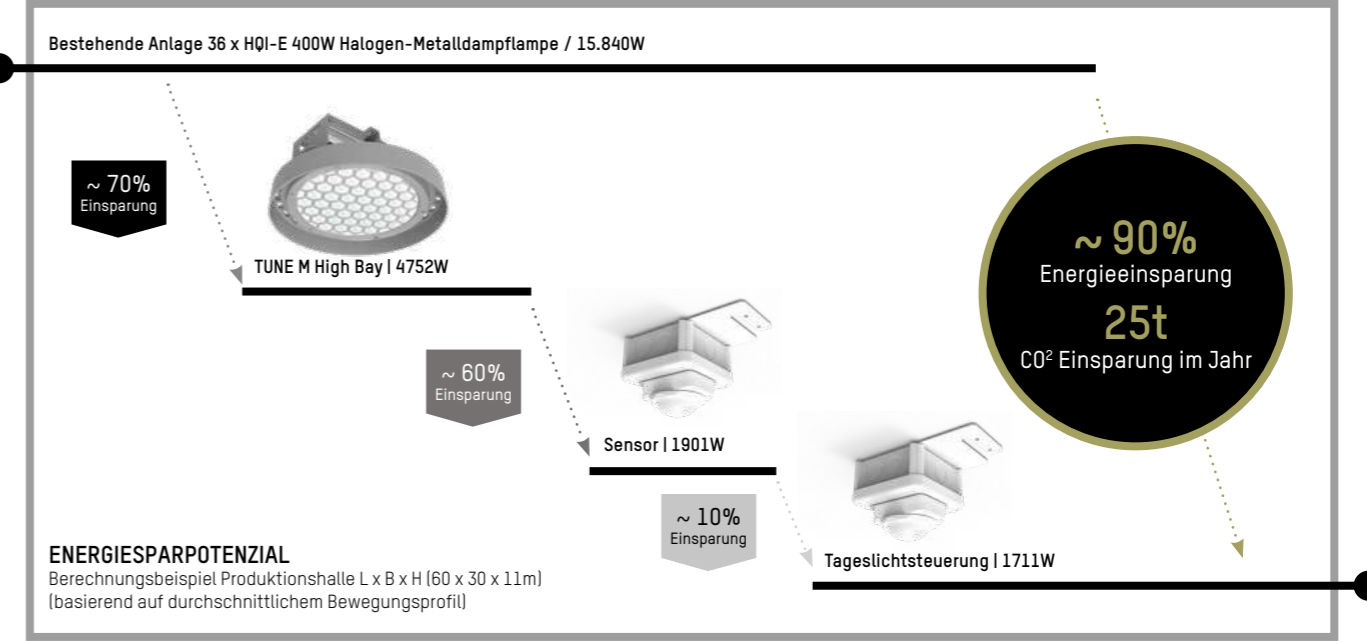



### TUNE HB S PC

#### INFORMATION

Hallenleuchte aus robustem Alugehäuse (IP66) für mittlere Montagehöhen in verschiedenen Bereichen z.B. Sport- und Mehrzweckhallen. Einpunktaufhängung, 1:1 Austausch bestehender Leuchten mit 250W Halogen-Metaldampflampen. Hervorragender Sehkomfort durch Wabenoptik (UGR bis <25), PC Abdeckung mit hoher Schlagfestigkeit IK10, lange Lebensdauer 70.000h L80 B10. Optional mit Ballwurfgitter.



Optional mit Ballwurfgitter

LEISTUNG	LUMEN	UGR	KELVIN	Ø x H	UMGEBUNGSTEMPERATUR	ART.NR.
SYS 150W	20380	<25	4000	280 x 176	-30° bis +45°	157-01CC01011444Y
SYS 145W	19980	<25	4000	280 x 176	-30° bis +45°	157-01CC00011444Y
SYS 133W	18480	<25	4000	280 x 176	-30° bis +45°	157-01CC02011444Y
SYS 116W	16400	<25	4000	280 x 176	-30° bis +45°	157-01CC03011444Y
SYS 98W	14260	<25	4000	280 x 176	-30° bis +50°	157-01CC04011444Y
SYS 85W	12860	<25	4000	280 x 176	-30° bis +50°	157-01CC05011444Y
SYS 71W	10980	<25	4000	280 x 176	-30° bis +50°	157-01CC06011444Y



### TUNE HB M PC

#### INFORMATION

Hallenleuchte aus robustem Alugehäuse (IP66) für höhere Montagehöhen in verschiedenen Bereichen z.B. Lebensmittelindustrie. Einpunktaufhängung, 1:1 Austausch bestehender Leuchten mit 400W Halogen-Metaldampflampen. Hervorragender Sehkomfort durch Wabenoptik (UGR bis <22/25), PC Abdeckung mit hoher Schlagfestigkeit IK10, lange Lebensdauer 70.000h L80 B10. Optional mit Ballwurfgitter.



Optional mit Ballwurfgitter

LEISTUNG	LUMEN	UGR	Ø x H	UMGEBUNGSTEMPERATUR	ART.NR.
SYS 205W	29070	<25	360 x 186	-30° bis +45°	157-02CC07011W44Y
SYS 190W	27250	<25	360 x 186	-30° bis +45°	157-02CC08011W44Y
SYS 175W	25190	<22	360 x 186	-30° bis +45°	157-02CC09011W44Y
SYS 165W	23960	<22	360 x 186	-30° bis +45°	157-02CC10011W44Y
SYS 150W	21900	<22	360 x 186	-30° bis +50°	157-02CC11011W44Y
SYS 132W	19600	<22	360 x 186	-30° bis +50°	157-02CC12011W44Y
SYS 113W	17100	<22	360 x 186	-30° bis +50°	157-02CC13011W44Y
SYS 98W	15020	<22	360 x 186	-30° bis +50°	157-02CC14011W44Y

#### ARTIKELNUMMER ERGÄNZEN

##### CC = ABDECKUNG

PC = 10  
PC + Ballwurfgitter = 11

##### W = LICHTFARBE

4000 = 4  
6500 = 6

##### Y = DIMMBAR

DALI-2 DIMM. = 2  
Schaltbar ON/OFF oder analog dim 1-10V = a

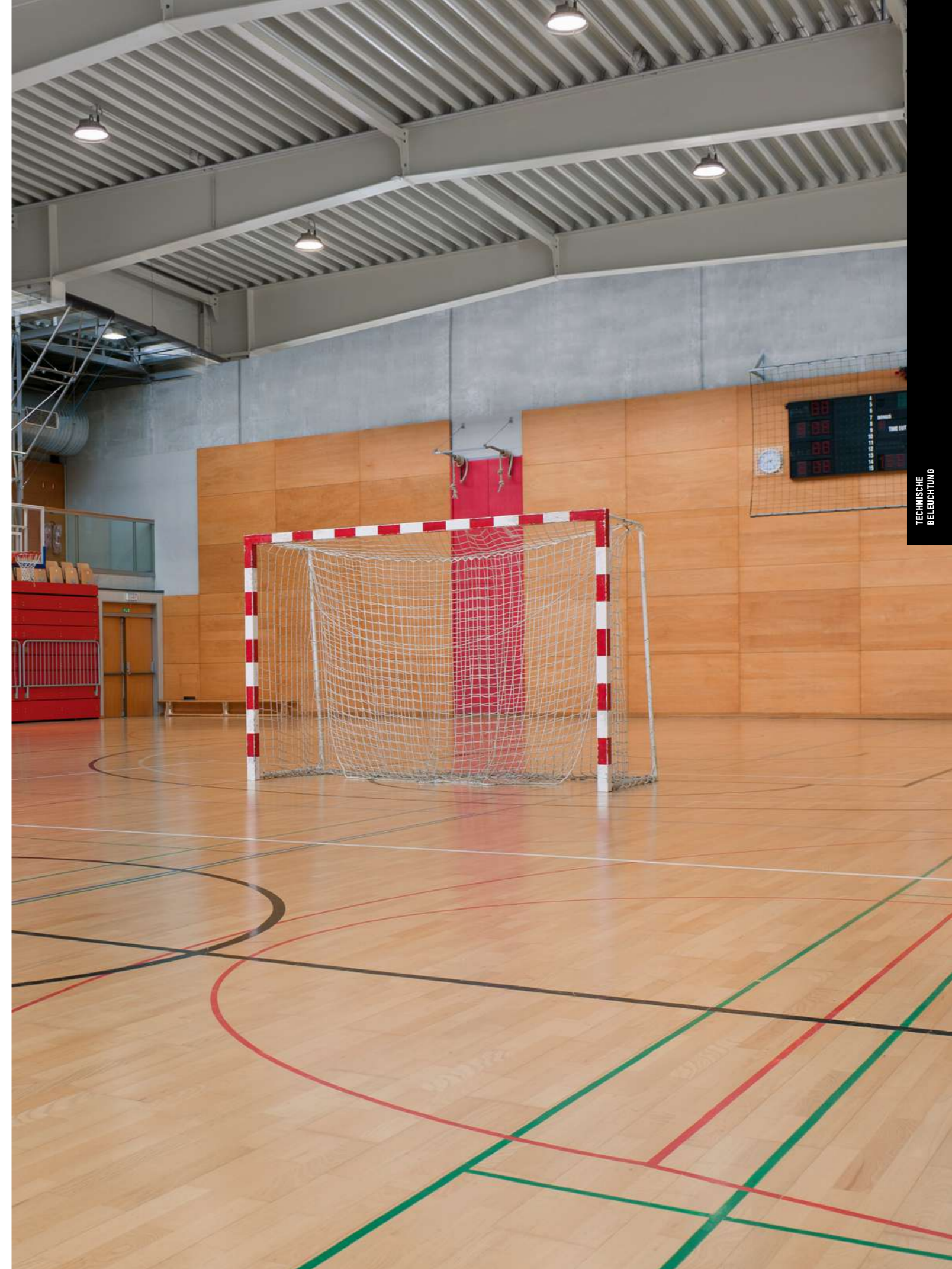

Bildretusche, Produkt: TUNE HB S PC



### TUNE HB S GLAS

#### INFORMATION

Hallenleuchte aus robustem Alugehäuse (IP66) für mittlere Montagehöhen in verschiedenen Bereichen z.B. Produktions- und Logistik-hallen. Einpunktaufhängung, 1:1 Austausch bestehender Leuchten mit 250W Halogen-Metaldampflampen. Hervorragender Sehkomfort durch Wabenoptik (UGR bis <25), chemisch beständige Glasabdeckung mit hoher Schlagfestigkeit IK08, lange Lebensdauer 70.000h L80 B10.

LEISTUNG	LUMEN	UGR	KELVIN	Ø x H	UMGEBUNGSTEMPERATUR	ART.NR.
SYS 150W	21050	<25	4000	280 x 176	-30° bis +45°	157-012001011444Y
SYS 145W	20640	<25	4000	280 x 176	-30° bis +45°	157-012000011444Y
SYS 133W	19090	<25	4000	280 x 176	-30° bis +45°	157-012002011444Y
SYS 116W	16940	<25	4000	280 x 176	-30° bis +45°	157-012003011444Y
SYS 98W	14730	<25	4000	280 x 176	-30° bis +50°	157-012004011444Y
SYS 85W	13280	<25	4000	280 x 176	-30° bis +50°	157-012005011444Y
SYS 71W	11340	<25	4000	280 x 176	-30° bis +50°	157-012006011444Y



### TUNE HB M GLAS

#### INFORMATION

Hallenleuchte aus robustem Alugehäuse (IP66) für höhere Montagehöhen in anspruchsvollen Industrieanlagen. Einpunktaufhängung, 1:1 Austausch bestehender Leuchten mit 400W Metaldampflampen. Hervorragender Sehkomfort durch Wabenoptik (UGR bis <22/25), chemisch beständige Glasabdeckung mit hoher Schlagfestigkeit IK08, lange Lebensdauer 70.000h L80 B10.

LEISTUNG	LUMEN	UGR	Ø x H	UMGEBUNGSTEMPERATUR	ART.NR.
SYS 205W	30030	<25	360 x 186	-30° bis +45°	157-022007011W44Y
SYS 190W	28150	<25	360 x 186	-30° bis +45°	157-022008011W44Y
SYS 175W	26020	<22	360 x 186	-30° bis +45°	157-022009011W44Y
SYS 165W	24750	<22	360 x 186	-30° bis +45°	157-022010011W44Y
SYS 150W	22620	<22	360 x 186	-30° bis +50°	157-022011011W44Y
SYS 132W	20250	<22	360 x 186	-30° bis +50°	157-022012011W44Y
SYS 113W	17660	<22	360 x 186	-30° bis +50°	157-022013011W44Y
SYS 98W	15520	<22	360 x 186	-30° bis +50°	157-022014011W44Y



### ARTIKELNUMMER ERGÄNZEN

W = LICHTFARBE

4000 = 4

6500 = 6

Y = DIMMBAR

DALI-2 DIMM. = 2

Schaltbar ON/OFF oder analog dim 1-10V = a



Projekt Eurogast Leoben, Österreich, Foto: Molto Luce, Produkt: TUNE HB S PC



### BEWEGUNGSMELDER AUFSATZ IP65

#### INFORMATION

Sensor ausgelegt als DALI-2 Application Controller, mit Konnektor, direkt an DALI-2 EVG anschließbar, Mesh-Netzwerk zur Vernetzung der Sensoren, Parametrierung und Konfigurierung via Bluetooth-App, Konstantlicht-Regelung, Vordefinierte Szenen, Haupt- und Grundlicht frei einstellbar, freie Definition von Leuchtengruppen mit konfigurierbarem Verhalten, bis zu 16 DALI LED Treiber anschließbar - einfacher Sensortausch mit Zhaga Schnittstelle

\* power supply unit



DALI PSU*	SENSOR	L x B x H	ART.NR.
ohne	3360	187 x 114 x 122	157-0066000000000
ohne	345	187 x 114 x 122	157-0067000000000

### BEWEGUNGSMELDER 3360

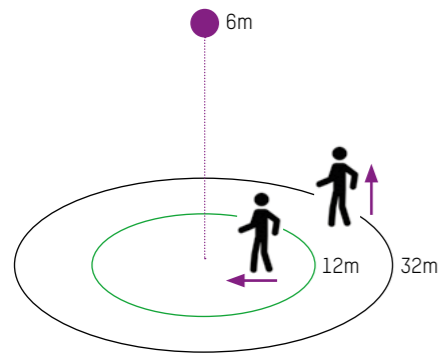

Mögliche Montagehöhe: 2.80 m – 14.00 m  
Grün: radial / Schwarz: tangential

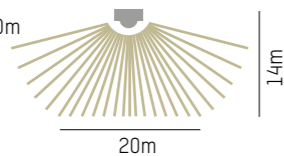

MONTAGEHÖHE	ERFASSUNGSBEREICH
14m	Ø 20m (tangential)
9m	Ø 28m (tangential)
6m	Ø 32m (tangential)

### BEWEGUNGSMELDER 345

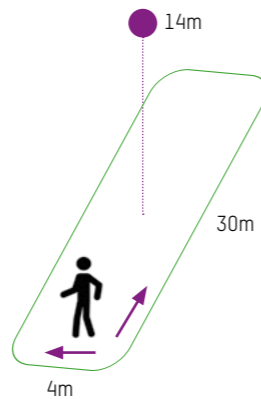



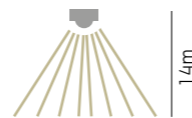

Mögliche Montagehöhe: 4.00 m – 14.00 m  
Grün: radial und tangential





MONTAGEHÖHE	ERFASSUNGSBEREICH
14m	30 x 4m
10m	25 x 4m
8m	20 x 4m
6m	15 x 4m

REFRAKTOR	INFORMATION	Ø x H	ART.NR.
	aus Polycarbonat	415 x 185	157-0055000000000

BALLWURFGITTER S	INFORMATION	FÜR MODELL	Ø	ART.NR.
	Schutzgitter aus Stahl	TUNE S	280	157-0053000000000
	Schutzgitter aus Stahl	TUNE M	360	157-0054000000000

MONTAGEBÜGEL	INFORMATION	FÜR MODELL	L x B x H	ART.NR.
	aus Aluminium, inkl. Befestigungsteile	TUNE S	252 x 190 x 42	157-0057000000000
	aus Aluminium, inkl. Befestigungsteile	TUNE M	279 x 230 x 42	157-0058000000000

HIGH BAY ADAPTER FÜR TRAIL SCHIENE	INFORMATION	POLIG	L x B	ART.NR.
	Systemeinsatz zur mechanischen Anbindung der High Bay Leuchte an Trail, Tragkraft: max. 10kg	7-polig	281 x 93	610-02830010000XX0
		11-polig	281 x 93	610-02830020000XX0

### ARTIKELNUMMER ERGÄNZEN

XX = FARBE



grau = 04



weiß = 05

schwarz = 06

AC STECKER & BUCHSE	INFORMATION	ART.NR.
	aus Kunststoff, IP66, 3-polig, Leiterquerschnitt 0,5mm <sup>2</sup> – 2,5mm <sup>2</sup>	157-0063000000000

KETTE	INFORMATION	ART.NR.
	Tragkraft: max. 30kg, Ø 2,2mm / Meterware	835-9926194

KARABINER	INFORMATION	ART.NR.
	Abhängung aus Stahl, IP66, 1 Stk.	157-0064000000000
	Abhängung aus Stahl, IP66, 10 Stk.	157-0065000000000

STAHLSEIL MIT ÖSE FÜR BEWEGUNGSMELDEREINSATZ	INFORMATION	Ø / L	ART.NR.
	werkzeuglose Montage, beliebig kürzbar	1,5 mm / L 1500 mm	610-0025000000000
		1,5 mm / L 3000 mm	610-0026000000000
		1,5 mm / L 6000 mm	610-0027000000000



### VIALED EVO / VIALED HIGH

INFORMATION	LEISTUNG	LUMEN	KELVIN	Ø x ET	Ø DA	MONTAGEHÖHE	FARBE	ART.NR.
Notlichtleuchte, Gehäuse aus selbstverlöschendem Kunststoff weiß, inkl. 2 Optiken (Antipanik- und Fluchtwegbeleuchtung) Aufladezeit: 12h, inkl. Konverter Brenndauer: 3 Stunden	SYS 5,3W	320	6000	85 x 48	60	max. 3 Meter	weiß	<b>282-ve03f30abr</b>
	SYS 5,3W	320	6000	85 x 48	60	max. 8 Meter	weiß	<b>282-vh03f30abr</b>



### LYRA EVO

INFORMATION	LEISTUNG	LUMEN	KELVIN	L x B x H	FARBE	ART.NR.
Rettungszeichenleuchte, Gehäuse aus selbstverlöschendem Kunststoff weiß, Aufladezeit: 12h, Erkennungsreichweite 32m, inkl. Piktogramm (1x links, 1x rechts, 2x nach unten), inkl. Decken-/ Wandbefestigung (parallel zur Wand), inkl. Konverter <b>Brenndauer: 3 Stunden</b>	SYS 2W	300	6000	289 x 34 x 261	weiß	<b>282-lv32n30abr</b>

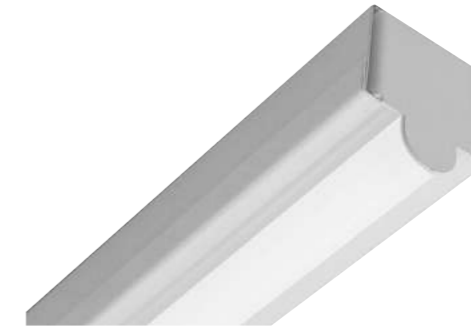

### TELX

INFORMATION	LEISTUNG	LUMEN	CRI>	KELVIN	L x B x H	FARBE	ART.NR.
LED Lichtleiste, Stahlblech, mit opalem Diffuser aus PMMA, inkl. LED Konverter	SYS 14W	2100	80	3000	605 x 38 x 47	weiß	<b>757-2116</b>
	SYS 14W	2100	80	4000	605 x 38 x 47	weiß	<b>757-2117</b>
	SYS 27W	4100	80	3000	1186 x 38 x 47	weiß	<b>757-2118</b>
	SYS 27W	4100	80	4000	1186 x 38 x 47	weiß	<b>757-2119</b>
	SYS 34W	5200	80	3000	1484 x 38 x 47	weiß	<b>757-2120</b>
	SYS 34W	5200	80	4000	1484 x 38 x 47	weiß	<b>757-2121</b>

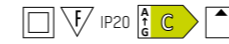

### SOL

INFORMATION	LEISTUNG	LUMEN	CRI>	KELVIN	L x B x H	FARBE	ART.NR.
Aufbauleuchte (Unterbauleuchte), eloxiertes Aluminium-Profil, opaler Diffusor, inkl. Schalter, inkl. Konverter	SYS 11W	1250	80	3000	600 x 32 x 43	aluminium eloxiert	<b>757-2112</b>
	SYS 11W	1250	80	4000	600 x 32 x 43	aluminium eloxiert	<b>757-2113</b>
	SYS 20W	2200	80	3000	1200 x 32 x 43	aluminium eloxiert	<b>757-2114</b>
	SYS 20W	2200	80	4000	1200 x 32 x 43	aluminium eloxiert	<b>757-2115</b>

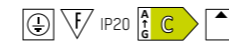



# LED SYSTEME

LED SYSTEME  
INNEN + AUSSEN



LED SYSTEME  
INNEN + AUSSEN

Ab sofort sind unsere LED-Stripes und Profile auch Online mit PC, Tablet oder Mobiltelefon konfigurierbar!

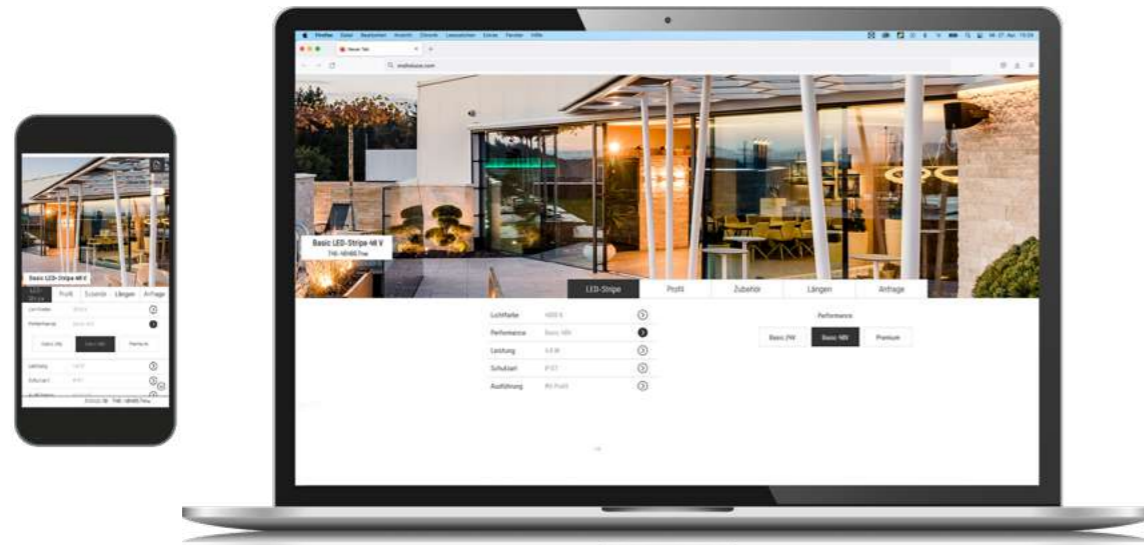

Projekt: Kurhotel Marienkron, Österreich  
Foto: Fotografie Gabriel Buechelmeier  
Produkt: PREMIUM LED STRIPE

LED SYSTEME  
INNEN + AUSSEN

LED SYSTEME  
INNEN + AUSSEN



Unsere LED-Stripes sind ab sofort rollenweise innerhalb von 24h versandbereit!



Jetzt einfach im Webshop bestellen:



**Achtung:** Unser 24h READY TO DELIVER Angebot gilt für den EU Raum!



Projekt: Karriere.at, Linz, Österreich  
Foto: Molto Luce  
Produkt: BASIC LED RGB



Projekt: Truckcenter Katzinger, Altenfelden, Österreich  
Foto: Leibz Interior Design Foto: Stöbich  
Produkt: PREMIUM LED STRIPE

**PREMIUM LED STRIPES IP65**



Leistung: 5; 9; 18 oder 28W/M  
Lichtfarben: 2500; 2700; 3000 oder 4000K  
MacAdam 3Step Binning  
CRI>90

Info: Seite 196 - 197

**BASIC LED STRIPES IP20**



Leistung: 4.8; 9.6 oder 14.4W/M  
Lichtfarben: 2700; 3000 oder 4000K  
MacAdam 3Step Binning  
CRI>80

Info: Seite 200 - 203

**LED STRIPES DIM2WARM IP20**



Leistung: 14.4W/M  
Lichtfarben: 3000-2200K oder 2700-2200K  
MacAdam 5Step Binning  
CRI>80

Info: Seite 204

**BASIC LED STRIPES IP67**



Leistung: 4.8 oder 14.4W/M  
Lichtfarben: 3000 oder 4000K  
MacAdam 3Step Binning  
CRI>80

Info: Seite 210

**LED STRIPES TUNABLE WHITE IP67**



Leistung: 14.4W/M  
Lichtfarben: 2700 - 6500K  
MacAdam 5Step Binning

Info: Seite 211

**BASIC 48V LED STRIPES IP67**



Leistung: 4.8W/M  
Lichtfarben: 3000 oder 4000K  
MacAdam 5Step Binning  
CRI>80

Info: Seite 212

**LED STRIPES TUNABLE WHITE IP20**



Leistung: 14.4W/M  
Lichtfarben: 2700 - 6500K  
MacAdam 5Step Binning

Info: Seite 205

**BASIC LED STRIPES RGB-W IP20**



Leistung: 18.1W/M  
Lichtfarben: RGB / W3000K  
MacAdam 3Step Binning

Info: Seite 208

**BASIC LED STRIPES RGB-W IP67**



Leistung: 18.1W/M  
Lichtfarben: RGB / W3000K  
MacAdam 3Step Binning

Info: Seite 214



### PREMIUM LED STRIPE 5W/M 10M ROLLE ODER METERWARE

INFORMATION	LEISTUNG	LUMEN/LFM	V DC	CRI>	KELVIN	L x B x H (mm)	VE	ART.NR.
Flexibles PREMIUM LED Stripe, IP65 mittels Plasma-beschichtung, Meterware, 120 LEDs / Meter, 5W / Meter, MacAdam 3Step Binning, trennbar alle 5cm, Befestigung durch doppelseitiges 3M Klebeband, exkl. Konverter, Montage auf wärmeleitendem Material Voraussetzung! Bitte kalkulieren Sie pro Zuschnitt 1 x 283-konf zusätzlich <b>ACHTUNG:</b> maximale Länge pro Einspeisepunkt 8m	LED 5W/m	440	24	90	2500	10000 x 5 x 1,4	Rolle	283-240565uuww
	LED 5W/m	470	24	90	2700	10000 x 5 x 1,4	Rolle	283-240565uww
	LED 5W/m	520	24	90	3000	10000 x 5 x 1,4	Rolle	283-240565ww
	LED 5W/m	580	24	90	4000	10000 x 5 x 1,4	Rolle	283-240565nw
	LED 5W/m	440	24	90	2500	lt. order x 5 x 1,4	Meterware	283-240565uuwwkonf
	LED 5W/m	470	24	90	2700	lt. order x 5 x 1,4	Meterware	283-240565uwwkonf
	LED 5W/m	520	24	90	3000	lt. order x 5 x 1,4	Meterware	283-240565wwkonf
	LED 5W/m	580	24	90	4000	lt. order x 5 x 1,4	Meterware	283-240565nwwkonf



### PREMIUM LED STRIPE 9W/M 30M ROLLE ODER METERWARE

INFORMATION	LEISTUNG	LUMEN/LFM	V DC	CRI>	KELVIN	L x B x H (mm)	VE	ART.NR.
Flexibles PREMIUM LED Stripe, IP65 mittels Plasma-beschichtung, Meterware, 120 LEDs / Meter, MacAdam 3Step Binning, trennbar alle 5cm, Befestigung durch doppelseitiges 3M Klebeband, exkl. Konverter, ist eine Montage auf wärmeleitendem Material Voraussetzung! Bitte kalkulieren Sie pro Zuschnitt 1 x 283-konf zusätzlich <b>ACHTUNG:</b> maximale Länge pro Einspeisepunkt 10m	LED 9W/m	950	24	90	2500	30000 x 8 x 1,4	Rolle	283-240965uuww
	LED 9W/m	1054	24	90	2700	30000 x 8 x 1,4	Rolle	283-240965uww
	LED 9W/m	1058	24	90	3000	30000 x 8 x 1,4	Rolle	283-240965ww
	LED 9W/m	1134	24	90	4000	30000 x 8 x 1,4	Rolle	283-240965nw
	LED 9W/m	950	24	90	2500	lt. order x 8 x 1,4	Meterware	283-240965uuwwkonf
	LED 9W/m	1054	24	90	2700	lt. order x 8 x 1,4	Meterware	283-240965uwwkonf
	LED 9W/m	1058	24	90	3000	lt. order x 8 x 1,4	Meterware	283-240965wwkonf
	LED 9W/m	1134	24	90	4000	lt. order x 8 x 1,4	Meterware	283-240965nwwkonf



### PREMIUM LED STRIPE 18W/M 30M ROLLE ODER METERWARE

INFORMATION	LEISTUNG	LUMEN/LFM	V DC	CRI>	KELVIN	L x B x H (mm)	VE	ART.NR.
Infos wie oben <b>ACHTUNG:</b> maximale Länge pro Einspeisepunkt 8m	LED 18W/m	1755	24	90	2500	30000 x 8 x 1,4	Rolle	283-241865uuww
	LED 18W/m	1934	24	90	2700	30000 x 8 x 1,4	Rolle	283-241865uww
	LED 18W/m	1980	24	90	3000	30000 x 8 x 1,4	Rolle	283-241865ww
	LED 18W/m	2148	24	90	4000	30000 x 8 x 1,4	Rolle	283-241865nw
	LED 18W/m	1755	24	90	2500	lt. order x 8 x 1,4	Meterware	283-241865uuwwkonf
	LED 18W/m	1934	24	90	2700	lt. order x 8 x 1,4	Meterware	283-241865uwwkonf
	LED 18W/m	1980	24	90	3000	lt. order x 8 x 1,4	Meterware	283-241865wwkonf
	LED 18W/m	2148	24	90	4000	lt. order x 8 x 1,4	Meterware	283-241865nwwkonf



### PREMIUM LED STRIPE 28W/M 30M ROLLE ODER METERWARE

INFORMATION	LEISTUNG	LUMEN/LFM	V DC	CRI>	KELVIN	L x B x H (mm)	VE	ART.NR.
Flexibles PREMIUM LED Stripe, IP65 mittels Plasma-beschichtung, Meterware, 120 LEDs / Meter, 18W / Meter, MacAdam 3Step Binning, trennbar alle 5cm, Befestigung durch doppelseitiges 3M Klebeband, exkl. Konverter, Montage auf wärmeleitendem Material Voraussetzung! Bitte kalkulieren Sie pro Zuschnitt 1 x 283-konf zusätzlich <b>ACHTUNG:</b> maximale Länge pro Einspeisepunkt 4m	LED 28W/m	2500	24	90	2500	30000 x 8 x 1,4	Rolle	283-242865uuww
	LED 28W/m	2890	24	90	2700	30000 x 8 x 1,4	Rolle	283-242865uww
	LED 28W/m	2922	24	90	3000	30000 x 8 x 1,4	Rolle	283-242865ww
	LED 28W/m	3191	24	90	4000	30000 x 8 x 1,4	Rolle	283-242865nw
	LED 28W/m	2500	24	90	2500	lt. order x 8 x 1,4	Meterware	283-242865uuwwkonf
	LED 28W/m	2890	24	90	2700	lt. order x 8 x 1,4	Meterware	283-242865uwwkonf
	LED 28W/m	2922	24	90	3000	lt. order x 8 x 1,4	Meterware	283-242865wwkonf
	LED 28W/m	3191	24	90	4000	lt. order x 8 x 1,4	Meterware	283-242865nwwkonf



### KONFEKTIONIERUNG PREMIUM LED STRIPES

INFORMATION	ART.NR.
LED Band IP65 pro Zuschnitt beinhaltet: Zuschnitt, 50cm Anschlusskabel gelötet, Ansnchnittversiegelung, Systemtest, ESD-Verpackung	283-konf



Projekt: Private residence, Österreich, Foto: Ben Elmecker / Martin Pröll, Produkt: PREMIUM LED STRIPE



Projekt: Private Residence, Österreich, Foto: Gabriel Büchelmeier, Produkt: BASIC LED STRIPE



### BASIC LED STRIPE 4,8W/M ROLLE 5 M ODER METERWARE

INFORMATION	LEISTUNG	LUMEN/LFM	V DC	CRI>	KELVIN	L x B x H (mm)	VE	ART.NR.
Flexibles BASIC LED Stripe, Rolle 5000mm, 300 SMD3528 LEDs, 60 LEDs / Meter, 4,8W / Meter, MacAdam 3Step Binning, trennbar alle 6 LEDs (ca. 10cm), Befestigung durch doppelseitiges 3M Klebeband, exkl. Konverter	LED 4,8W/m	400	24	80	2700	5000 x 8 x 3	Rolle	746-1242420uw
	LED 4,8W/m	440	24	80	3000	5000 x 8 x 3	Rolle	746-1242420ww
	LED 4,8W/m	473	24	80	4000	5000 x 8 x 3	Rolle	746-1242420nw
ACHTUNG: Keine Beständigkeit gegen chemische Substanzen oder Dämpfe (z.B. Chlor u. dgl.); Um eine lange Lebensdauer und einwandfreie Funktion der LED-Stripes zu garantieren, ist eine Montage auf wärmeleitendem Material Voraussetzung! Bitte kalkulieren Sie pro Zuschnitt 1 x 746-konfIP20 zusätzlich <b>ACHTUNG:</b> maximale Länge pro Einspeisepunkt 10m	LED 4,8W/m	400	24	80	2700	lt. order x 8 x 3	Meterware	746-1242420uwkonf
	LED 4,8W/m	470	24	80	3000	lt. order x 8 x 3	Meterware	746-1242420wwkonf
	LED 4,8W/m	473	24	80	4000	lt. order x 8 x 3	Meterware	746-1242420nwkonf

#### ZUBEHÖR



#### INFO

INFO	ART.NR.
SCHNELLEINSPEISER inkl. 200mm Kabel	746-fc1220w
SCHNELLVERBINDER	746-lc1220w
LINEARVERBINDER FLEX. inkl. 100mm Kabel	746-lcf1220w

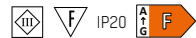

### BASIC LED STRIPE 9,6W/M ROLLE 5 M ODER METERWARE

INFORMATION	LEISTUNG	LUMEN/LFM	V DC	CRI>	KELVIN	L x B x H (mm)	VE	ART.NR.
Flexibles BASIC LED Stripe, Rolle 5000mm, 300 SMD3528 LEDs, 60 LEDs / Meter, 9,6W / Meter, MacAdam 3Step Binning, trennbar alle 6 LEDs (ca. 10cm), Befestigung durch doppelseitiges 3M Klebeband, exkl. Konverter	LED 9,6W/m	900	24	80	2700	5000 x 8 x 3	Rolle	746-1244820uw
	LED 9,6W/m	983	24	80	3000	5000 x 8 x 3	Rolle	746-1244820ww
	LED 9,6W/m	1006	24	80	4000	5000 x 8 x 3	Rolle	746-1244820nw
ACHTUNG: Keine Beständigkeit gegen chemische Substanzen oder Dämpfe (z.B. Chlor u. dgl.); Um eine lange Lebensdauer und einwandfreie Funktion der LED-Stripes zu garantieren, ist eine Montage auf wärmeleitendem Material Voraussetzung! Bitte kalkulieren Sie pro Zuschnitt 1 x 746-konfIP20 zusätzlich <b>ACHTUNG:</b> maximale Länge pro Einspeisepunkt 7m	LED 9,6W/m	900	24	80	2700	lt. order x 8 x 3	Meterware	746-1244820uwkonf
	LED 9,6W/m	983	24	80	3000	lt. order x 8 x 3	Meterware	746-1244820wwkonf
	LED 9,6W/m	1006	24	80	4000	lt. order x 8 x 3	Meterware	746-1244820nwkonf

#### ABBILDUNG



#### INFO

INFO	ART.NR.
SCHNELLEINSPEISER inkl. 200mm Kabel	746-fc1220w
SCHNELLVERBINDER	746-lc1220w
LINEARVERBINDER FLEX. inkl. 100mm Kabel	746-lcf1220w



### KONFEKTIONIERUNG BASIC LED STRIPES IP20

INFORMATION	ART.NR.
LED Band IP20 pro Zuschnitt beinhaltet: Zuschnitt, 50cm Anschlusskabel gelötet, Systemtest, ESD-Verpackung	746-konfip20



Projekt: Hilton Hotel, TECA Aberdeen, Schottland, Foto: Paul Zanre, Produkt: BASIC LED STRIPE



Projekt: Private Residence, Österreich, Foto: Molto Luce, Produkt: BASIC LED STRIPE



Projekt: Pfeffermühle, Österreich, Foto: Tischlerei Kotrasch, Produkt: BASIC LED STRIPE



### BASIC LED STRIPE 14,4W/M ROLLE 5 M ODER METERWARE

INFORMATION	LEISTUNG	LUMEN/LFM	V DC	CRI>	KELVIN	L x B x H (mm)	VE	ART.NR.
Flexibles BASIC LED Stripe, Rolle 5000mm, 300 SMD5060 LEDs, 60 LEDs / Meter, 14,4W / Meter, MacAdam 3Step Binning, trennbar alle 6 LEDs (ca. 10cm), Befestigung durch doppelseitiges 3M Klebeband, exkl. Konverter,	LED 14,4W/m	1280	24	80	2700	5000 x 12 x 4	Rolle	746-1247220uw
	LED 14,4W/m	1395	24	80	3000	5000 x 12 x 4	Rolle	746-1247220ww
	LED 14,4W/m	1475	24	80	4000	5000 x 12 x 4	Rolle	746-1247220nw
ACHTUNG: Keine Beständigkeit gegen chemische Substanzen oder Dämpfe (z.B. Chlor u. dgl.); Um eine lange Lebensdauer und einwandfreie Funktion der LED-Stripes zu garantieren, ist eine Montage auf wärmeleitendem Material Voraussetzung! Bitte kalkulieren Sie pro Zuschnitt 1 x 746-konfIP20 zusätzlich ACHTUNG: maximale Länge pro Einspeisepunkt 5m	LED 14,4W/m	1280	24	80	2700	lt. order x 12 x 4	Meterware	746-1247220uwkonf
	LED 14,4W/m	1395	24	80	3000	lt. order x 12 x 4	Meterware	746-1247220wwkonf
	LED 14,4W/m	1475	24	80	4000	lt. order x 12 x 4	Meterware	746-1247220nwkonf

#### ZUBEHÖR



#### INFO

INFO	ART.NR.
SCHNELLEINSPEISER inkl. 200mm Kabel	746-fc2420w
SCHNELLVERBINDER	746-lc2420w
LINEARVERBINDER FLEX. inkl. 100mm Kabel	746-lcf2420w



### KONFEKTIONIERUNG BASIC LED STRIPES IP20

INFORMATION	ART.NR.
LED Band IP20 pro Zuschnitt beinhaltet: Zuschnitt, 50cm Anschlusskabel gelötet, Systemtest, ESD-Verpackung	746-konfip20



Projekt: Private Residence, Österreich, Foto: Interieur Design Leibez, Produkt: BASIC LED STRIPE



**LED STRIPE DIM2WARM 14,4W/M ROLLE 5M**

INFORMATION	LEISTUNG	LUMEN/LFM	V DC	CRI>	KELVIN	L x B x H (mm)	ART.NR.
Flexibles BASIC LED Stripe, Rolle 5000mm, 120 SMD2835 LEDs pro Meter 14,4W/m, MacAdam 5 Step Binning, trennbar alle 10cm, Befestigung durch doppelseitiges 3M Klebeband, exkl. Konverter <b>ACHTUNG:</b> Keine Beständigkeit gegen chemische Substanzen oder Dämpfe (z.B. Chlor u. dgl.); Um eine lange Lebensdauer und einwandfreie Funktion der LED-Stripes zu garantieren, ist eine Montage auf wärmeleitendem Material Voraussetzung! <b>ACHTUNG:</b> maximale Länge pro Einspeisepunkt 5m	LED 14,4W/m	1330	24	80	3000-2200	5000 x 12 x 1,4	746-247220wd2w
	LED 14,4W/m	1270	24	80	2700-2200	5000 x 12 x 1,4	746-247220ud2w



Projekt: Hotel Almlust, Flachau, Österreich, Foto: Hotel Almlust, Produkt: BASIC LED STRIPE



**LED STRIPE TUNABLE WHITE 14,4W/M ROLLE 5M**

INFORMATION	LEISTUNG	LUMEN/LFM	V DC	CRI>	KELVIN	L x B x H (mm)	ART.NR.
Flexibles BASIC LED Stripe, Rolle 5000mm, 120 SMD2835 LEDs pro Meter 14,4W/m, MacAdam 5 Step Binning, trennbar alle 10cm, Befestigung durch doppelseitiges 3M Klebeband, exkl. Konverter <b>ACHTUNG:</b> Keine Beständigkeit gegen chemische Substanzen oder Dämpfe (z.B. Chlor u. dgl.); Um eine lange Lebensdauer und einwandfreie Funktion der LED-Stripes zu garantieren, ist eine Montage auf wärmeleitendem Material Voraussetzung! <b>ACHTUNG:</b> maximale Länge pro Einspeisepunkt 5m	LED 14,4W/m	2700-736	24	80	2700-6500	5000 x 10 x 1,4	746-241420tw
		6500-782					



Projekt: Private Residence, Österreich, Foto: Molto Luce, Produkt: BASIC LED STRIPE







Projekt: Restaurant OX, Plus City Pasching, Österreich, Foto: LSD, Produkt: LED STRIPE RGB



Projekt: Wohnhaus, Österreich, Foto: Molto Luce, Produkt: LED STRIPE RGB



Projekt: Hotel Flachauerhof, Österreich, Produkt: LED STRIPE RGB/W



**BASIC LED STRIPE RGBW 18,1W/M ROLLE 5M**

INFORMATION	LEISTUNG	LUMEN/LFM	V DC	CRI>	KELVIN	L x B x H (mm)	ART.NR.
Flexibles BASIC LED Stripe RGB-W, Rolle 5000mm, 480 SMD LEDs, 48 SMD RGB 5050 LEDs/Meter, 48 SMD 2835 LEDs/Meter, 18,1W/Meter, trennbar alle 12 LEDs (ca. 10cm) Befestigung durch doppelseitiges Klebeband, exkl. Konverter	LED 18,1W/m	101 ROT 279 GRÜN 65 BLAU 428 WEISS	24	---	RGB+ 3000	5000 x 12 x 2,5	746-1249120rgbw

**ACHTUNG:** Keine Beständigkeit gegen chemische Substanzen oder Dämpfe (z.B. Chlor u. dgl.); Um eine lange Lebensdauer und einwandfreie Funktion der LED-Stripes zu garantieren, ist eine Montage auf wärmeleitendem Material Voraussetzung!  
**ACHTUNG:** maximale Länge pro Einspeisepunkt 5m



Projekt: Kreisel Electric, Österreich, Planung / Umsetzung: Ben Elmecker, Foto: Martin Pröll, Produkt: LED STRIPE RGB



Projekt: Andels Hotel, Lodz, Polen, Planung: OP Architekten, Produkt: LED STRIPE RGB



Projekt: Hotel Matschner, Ramsau, Österreich, Foto: Tischlerei Kotrasch, Produkt: LED STRIPE RGB



### BASIC LED STRIPE 4,8W/M ROLLE 5M

#### INFORMATION

Flexibles BASIC LED Stripe, Rolle 5000mm, 300 SMD3528 LEDs, 60 LEDs / Meter, 4,8W / Meter, trennbar alle 6 LEDs (ca. 10cm), Band muss nach Trennung versiegelt werden!, Befestigung durch doppelseitiges 3M Klebeband, inkl. DC Stecker und 2 Buchsen, exkl. Konverter

**ACHTUNG:** Keine Beständigkeit gegen chemische Substanzen oder Dämpfe (z.B. Chlor u. dgl.); Um eine lange Lebensdauer und einwandfreie Funktion der LED-Stripes zu garantieren, ist eine Montage auf wärmeleitendem Material Voraussetzung!

**ACHTUNG:** maximale Länge pro Einspeisepunkt 5m



LEISTUNG	LUMEN	V DC	CRI>	KELVIN	L x B x H (mm)	ART.NR.
LED 4,8W/m	350	24	80	3000	5000 x 10 x 4	746-1242467ww
LED 4,8W/m	370	24	80	4000	5000 x 10 x 4	746-1242467nw

#### ZUBEHÖR

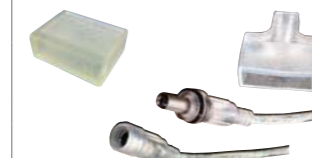

separat ordern

#### INFO

INFO	ART.NR.
SILIKONENDKAPPE	746-1003
SCHRUMPFSCHLAUCH	746-1004
EINSPEISUNGSABDECKUNG	746-1101
DC STECKER inkl. 130mm Kabel	746-1100
DC BUCHSE inkl. 130mm Kabel	746-1200



### BASIC LED STRIPE 14,4W/M ROLLE 5M

#### INFORMATION

Flexibles BASIC LED Stripe, Rolle 5000mm, 300 SMD5060 LEDs, 60 LEDs / Meter, 14,4W / Meter, trennbar alle 6 LEDs (ca. 10cm), Band muss nach Trennung versiegelt werden!, Befestigung durch doppelseitiges 3M Klebeband, inkl. DC Stecker und 2 Buchsen, exkl. Konverter

**ACHTUNG:** Keine Beständigkeit gegen chemische Substanzen oder Dämpfe (z.B. Chlor u. dgl.); Um eine lange Lebensdauer und einwandfreie Funktion der LED-Stripes zu garantieren, ist eine Montage auf wärmeleitendem Material Voraussetzung!

**ACHTUNG:** maximale Länge pro Einspeisepunkt 5m



LEISTUNG	LUMEN	V DC	CRI>	KELVIN	L x B x H (mm)	ART.NR.
LED 14,4W/m	1090	24	80	3000	5000 x 14,2 x 4	746-1247267ww
LED 14,4W/m	1130	24	80	4000	5000 x 14,2 x 4	746-1247267nw

#### ZUBEHÖR

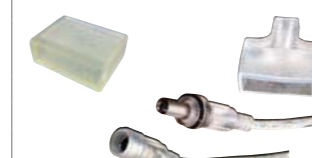

separat ordern

#### INFO

INFO	ART.NR.
SILIKONENDKAPPE	746-1001
SCHRUMPFSCHLAUCH	746-1004
EINSPEISUNGSABDECKUNG	746-1101
DC STECKER inkl. 130mm Kabel	746-1100
DC BUCHSE inkl. 130mm Kabel	746-1200



### LED STRIPE TUNABLE WHITE 14,4W/M ROLLE 5M

#### INFORMATION

Flexibles BASIC LED Stripe, Rolle 5000mm, SMD2835 LEDs, 120 LEDs / Meter, 14,4W / Meter, trennbar alle 6 LEDs (ca. 10cm), Band muss nach Trennung versiegelt werden!, Befestigung durch doppelseitiges 3M Klebeband, inkl. DC Stecker und 2 Buchsen, exkl. Konverter

**ACHTUNG:** Keine Beständigkeit gegen chemische Substanzen oder Dämpfe (z.B. Chlor u. dgl.); Um eine lange Lebensdauer und einwandfreie Funktion der LED-Stripes zu garantieren, ist eine Montage auf wärmeleitendem Material Voraussetzung!

**ACHTUNG:** maximale Länge pro Einspeisepunkt 5m



LEISTUNG	LUMEN	V DC	CRI>	KELVIN	L x B x H (mm)	ART.NR.
LED 14,4W/m	519	24	80	2700 - 6500	5000 x 12 x 5,5	746-241467tw
	526	24				

#### ZUBEHÖR



separat ordern

#### INFO

INFO	ART.NR.
SILIKONENDKAPPE	746-1006
SCHRUMPFSCHLAUCH	746-1004
EINSPEISUNGSABDECKUNG	746-1102



Projekt: Kreisel Electric, Österreich, Planung / Umsetzung: Ben Elmecker, Foto: Martin Pröll, Produkt: LED STRIPE IP67



### BASIC 48V LED STRIPE IP67 4,8W/M ROLLE 10M

#### INFORMATION

Flexibles BASIC LED Stripe; 48V Versorgungsspannung, Rolle 10m | 120 LED/M, MacAdam 5Step Binning, trennbar alle 10cm, Band muss nach Trennung versiegelt werden! Befestigung durch doppelseitiges 3M Klebeband, exkl. Konverter

**ACHTUNG:** Keine Beständigkeit gegen chemische Substanzen oder Dämpfe (z.B. Chlor u. dgl.); Um eine lange Lebensdauer und einwandfreie Funktion der LED-Stripes zu garantieren, ist eine Montage auf wärmeleitendem Material Voraussetzung!

**ACHTUNG:** maximale Länge pro Einspeisepunkt 10m



LEISTUNG	LUMEN	V DC	CRI>	KELVIN	L x B x H (mm)	ART.NR.
LED 4,8W/m	418	48	80	3000	10000 x 14 x 6	746-484867ww
LED 4,8W/m	418	48	80	4000	10000 x 14 x 6	746-484867nw

#### ZUBEHÖR





separat ordern



#### INFO

	ART.NR.
SILIKONENDKAPPE	746-1007
SCHRUMPFSCHLAUCH	746-1004
EINSPEISUNGSABDECKUNG	746-1104
DC STECKER inkl. 130mm Kabel	746-1100
DC BUCHSE inkl. 130mm Kabel	746-1200

48V

KONVERTER 50W SCHALTBAR	INFORMATION	WATT	V DC	V AC	L x B x H (mm)	FARBE	ART.NR.
	nicht dimmbar	50W	48	230	225 x 60 x 36	weiß	24-122766

KONVERTER 150W SCHALTBAR	INFORMATION	WATT	V DC	V AC	L x B x H (mm)	FARBE	ART.NR.
	nicht dimmbar	150W	48	230	240 x 60 x 49	weiß	24-122764

UNIVERSALDIMMER	INFORMATION	V DC	V AC	L x B x H (mm)	FARBE	ART.NR.
	Universaldimmer 1 Kanal, separater Steuereingang für DALI, 1-10V, Push, Sync Anschluß für bis zu 9 Slaves bei 1-10V oder Push Ansteuerung, max. Anschluß: 5A Zugentlastung separat ordern	12 - 50	230	153 x 30 x 21	weiß	322-ud3000
	<b>ZUGENTLASTUNG</b> für 1-Kanal Universaldimmer, 2 Stück					322-ud7001

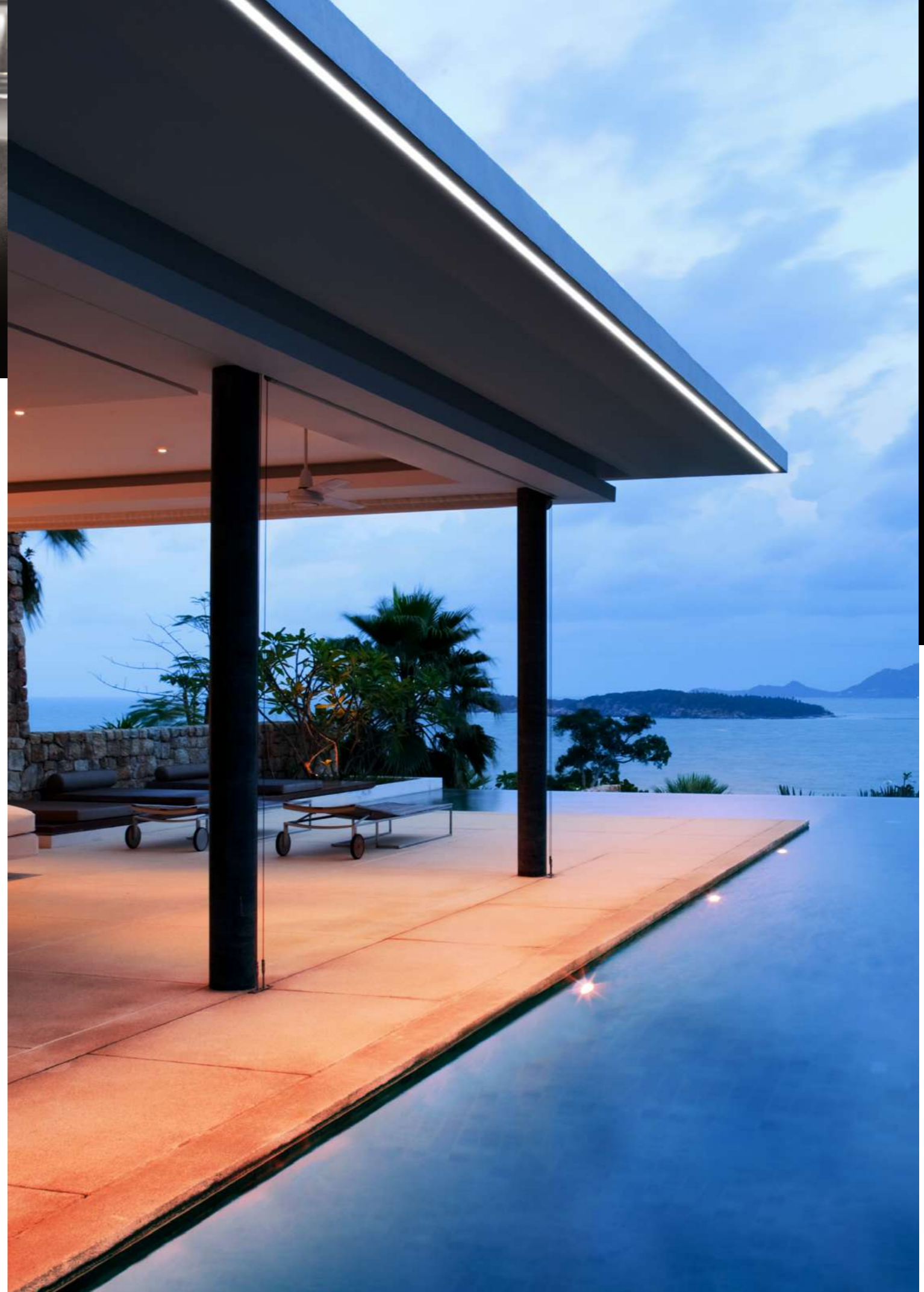



**BASIC LED STRIPE RGBW 18,1W/M ROLLE 5M**

INFORMATION	LEISTUNG	LUMEN	V DC	CRI>	KELVIN	L x B x H (mm)	ART.NR.
Flexibles BASIC LED Stripe RGB-, Rolle 5000mm, 480 SMD LEDs, 48 SMD RGB 5050 LEDs/Meter, 48 SMD 2835 LEDs/Meter, 18,1W/Meter, trennbar alle 12 LEDs (ca. 10cm), Band muss nach Trennung versiegelt werden! Befestigung durch doppelseitiges 3M Klebeband, exkl. Konverter	LED 18,1W/m	78 ROT 198 GRÜN 52 BLAU 294 WEISS	24	80 (WEISS)	RGB+ 3000	5000 x 15 x 5,5	746-1249167rgbw

**ACHTUNG:** Keine Beständigkeit gegen chemische Substanzen oder Dämpfe (z.B. Chlor u. dgl.); Um eine lange Lebensdauer und einwandfreie Funktion der LED-Stripes zu garantieren, ist eine Montage auf wärmeleitendem Material Voraussetzung!

**ACHTUNG:** maximale Länge pro Einspeisepunkt 5m



Projekt: Dorfbahn, Gerlos, Österreich, Foto: Dorfbahn Gerlos, Produkt: LED STRIPE RGB / W IP67

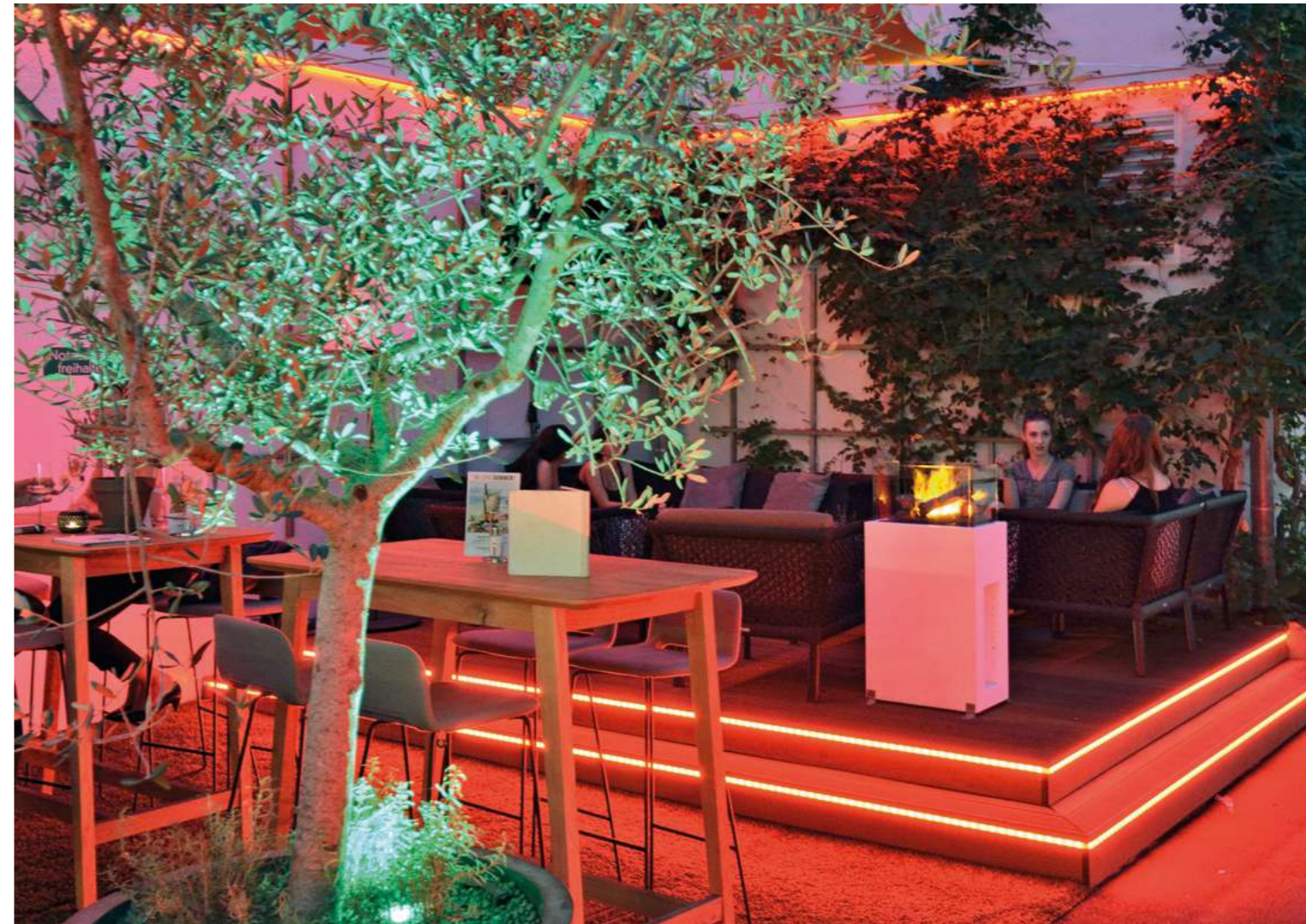

Projekt: Cafe Central, Linz, Österreich, Foto: LSD, Produkt: LED STRIPE RGB IP67

AUFBAUPROFILE AUS ALUMINIUM FÜR LED STRIPES

MINI 10 AUFBAU



MINI 14 AUFBAU



MINI 17 AUFBAU



MIDI AUFBAU



MAXI AUFBAU



MEGA AUFBAU



MINI CORNER AUFBAU



MIDI CORNER AUFBAU



MIDI CORNER AUFBAU

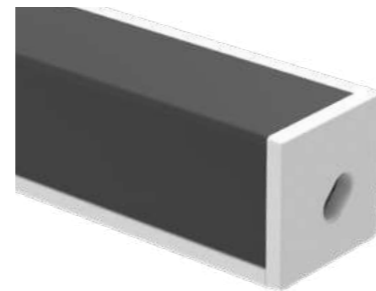

MAXI CORNER AUFBAU

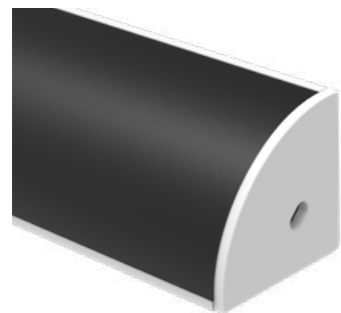

MAXI CORNER AUFBAU

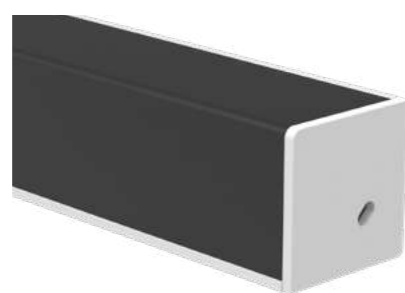

FLEX AUFBAU



MIDI CUBE AUFBAU

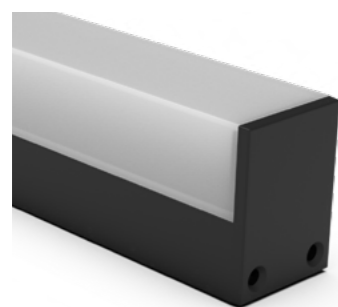

MAXI SOFT AUFBAU

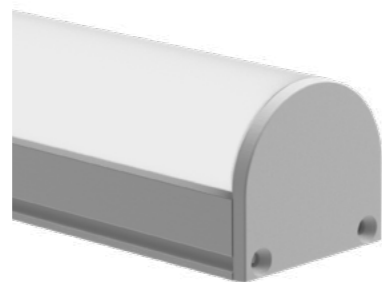

RIDE AUFBAUPROFIL



EINBAUPROFILE AUS ALUMINIUM FÜR LED STRIPES

MINI 10 EINBAU



MINI 14 EINBAU

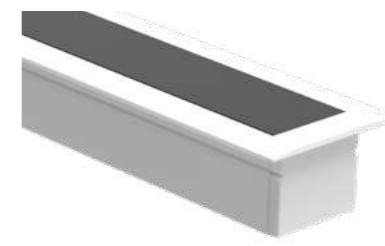

MINI 17 EINBAU



MIDI EINBAU



MAXI EINBAU



RIDE EINBAUPROFIL



MAXI Einbauprofil mit schwarzer opaler Abdeckung

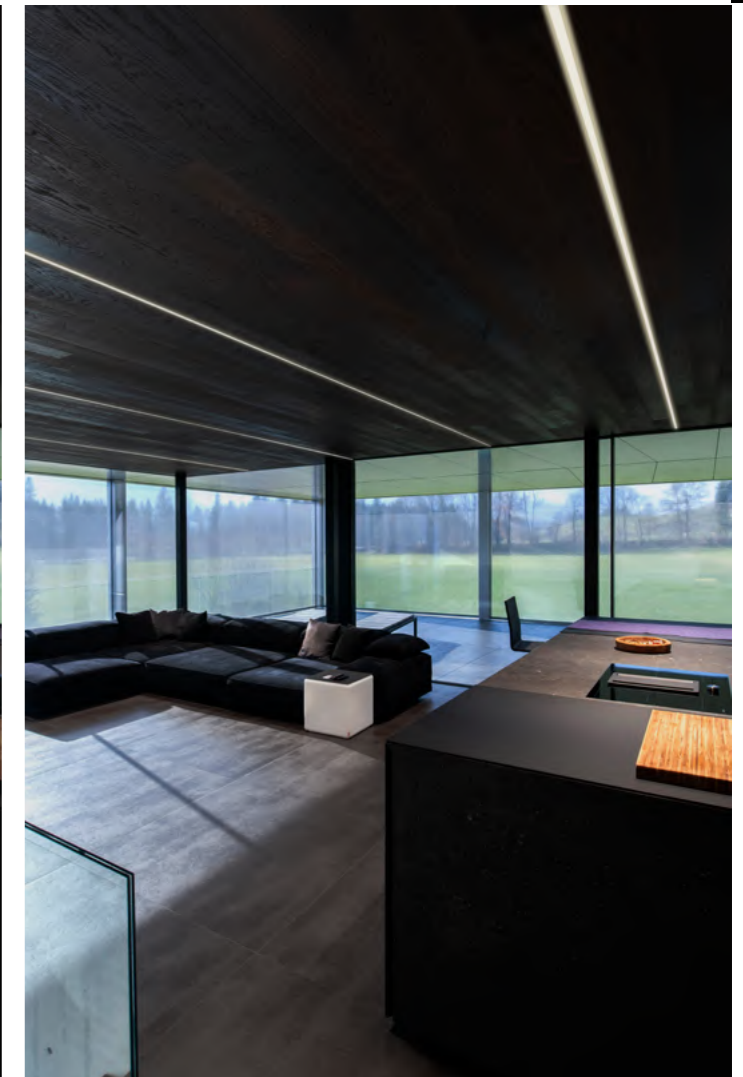

## AUFBAUPROFILE AUS ALUMINIUM FÜR LED STRIPES

### MINI 10 AUFBAU

Aufbauprofil MINI 10 für LED Flexbänder bis Breite 5mm, HINWEIS: für LED Bänder bis max. 5 Watt

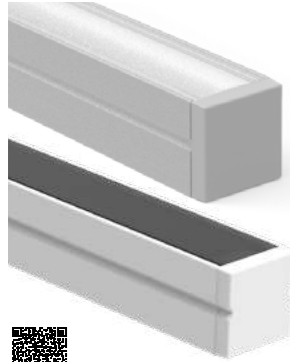

INFORMATION	DETAIL	L x B x H (mm)	FARBE	ART.NR.
PROFIL		2000 x 10 x 10	weiß	600-1a201w
PROFIL		2000 x 10 x 10	schwarz	600-1a201b
PROFIL		2000 x 10 x 10	aluminium eloxiert	600-1a201s
INFORMATION	DETAIL	MATERIAL	FARBE	ART.NR.
ENDKAPPEN (Set 2 Stk.)		KUNSTSTOFF	weiß	600-1aek201w
ENDKAPPEN (Set 2 Stk.)		KUNSTSTOFF	schwarz	600-1aek201b
ENDKAPPEN (Set 2 Stk.)		KUNSTSTOFF	silber	600-1aek201s
INFORMATION	DETAIL	MATERIAL	FARBE	ART.NR.
ABDECKUNG		PMMA WEISS OPAL	weiß opal	600-1c201
ABDECKUNG		PMMA SCHWARZ OPAL	schwarz opal	600-cb201
INFORMATION	DETAIL	MATERIAL	FARBE	ART.NR.
MONTAGECLIPS (2 Stk.)		EDELSTAHL	EDELSTAHL	600-mc201

### MINI 14 AUFBAU

Aufbauprofil MINI 14 für LED Flexbänder bis Breite 8mm, HINWEIS: für LED Bänder bis max. 9 Watt



INFORMATION	DETAIL	L x B x H (mm)	FARBE	ART.NR.
PROFIL		2000 x 14 x 8	weiß	600-1a202w
PROFIL		2000 x 14 x 8	schwarz	600-1a202b
PROFIL		2000 x 14 x 8	aluminium eloxiert	600-1a202s
INFORMATION	DETAIL	MATERIAL	FARBE	ART.NR.
ENDKAPPEN (Set 2 Stk.)		KUNSTSTOFF	weiß	600-1aek202w
ENDKAPPEN (Set 2 Stk.)		KUNSTSTOFF	schwarz	600-1aek202b
ENDKAPPEN (Set 2 Stk.)		KUNSTSTOFF	silber	600-1aek202s
INFORMATION	DETAIL	MATERIAL	FARBE	ART.NR.
ABDECKUNG		PMMA WEISS OPAL	weiß opal	600-1c202
ABDECKUNG		PMMA SCHWARZ OPAL	schwarz opal	600-cb202
INFORMATION	DETAIL	MATERIAL	FARBE	ART.NR.
MONTAGECLIPS (2 Stk.)		EDELSTAHL	EDELSTAHL	600-amc202

### MINI 17 AUFBAU

Aufbauprofil MINI 17 für LED Flexbänder bis Breite 12mm, HINWEIS: für LED Bänder bis max. 18 Watt



INFORMATION	DETAIL	L x B x H (mm)	FARBE	ART.NR.
PROFIL		2000 x 17 x 8,8	weiß	600-a203w
PROFIL		2000 x 17 x 8,8	schwarz	600-a203b
PROFIL		2000 x 17 x 8,8	aluminium eloxiert	600-a203s
INFORMATION	DETAIL	MATERIAL	FARBE	ART.NR.
ENDKAPPEN (Set 2 Stk.)		KUNSTSTOFF	weiß	600-aek203w
ENDKAPPEN (Set 2 Stk.)		KUNSTSTOFF	schwarz	600-aek203b
ENDKAPPEN (Set 2 Stk.)		KUNSTSTOFF	silber	600-aek203s
INFORMATION	DETAIL	MATERIAL	FARBE	ART.NR.
ABDECKUNG		PMMA WEISS OPAL	weiß opal	600-c203
INFORMATION	DETAIL	MATERIAL	FARBE	ART.NR.
MONTAGECLIPS (2 Stk.)		EDELSTAHL	EDELSTAHL	600-mc203

## EINBAUPROFILE AUS ALUMINIUM FÜR LED STRIPES

### MINI 10 EINBAU

Einbauprofil MINI 10 für LED Flexbänder bis Breite 5mm, HINWEIS: für LED Bänder bis max. 5 Watt, ET: 15mm, Ausschnitt: B: 12mm; Bei Verwendung von Endkappen: Profillänge + 4mm

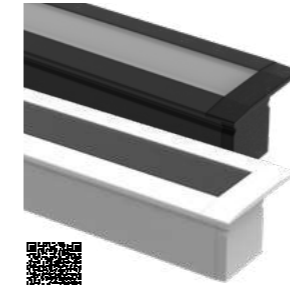

INFORMATION	DETAIL	L x B x H (mm)	FARBE	ART.NR.
PROFIL		2000 x 18 x 13	weiß	600-1e201w
PROFIL		2000 x 18 x 13	schwarz	600-1e201b
PROFIL		2000 x 18 x 13	aluminium eloxiert	600-1e201s
INFORMATION	DETAIL	MATERIAL	FARBE	ART.NR.
ENDKAPPEN (Set 2 Stk.)		KUNSTSTOFF	weiß	600-1eek201w
ENDKAPPEN (Set 2 Stk.)		KUNSTSTOFF	schwarz	600-1eek201b
ENDKAPPEN (Set 2 Stk.)		KUNSTSTOFF	silber	600-1eek201s
INFORMATION	DETAIL	MATERIAL	FARBE	ART.NR.
ABDECKUNG		PMMA WEISS OPAL	weiß opal	600-0c201
ABDECKUNG		PMMA SCHWARZ OPAL	schwarz opal	600-cb201
INFORMATION	DETAIL	MATERIAL	FARBE	ART.NR.
MONTAGECLIPS (2 Stk.)		EDELSTAHL	EDELSTAHL	600-mc201

### MINI 14 EINBAU

Einbauprofil MINI 14 für LED Flexbänder bis Breite 8mm, HINWEIS: für LED Bänder bis max. 9 Watt, ET: 15mm, Ausschnitt: B: 16mm; Bei Verwendung von Endkappen: Profillänge + 4mm



INFORMATION	DETAIL	L x B x H (mm)	FARBE	ART.NR.
PROFIL		2000 x 22 x 13	weiß	600-1e202w
PROFIL		2000 x 22 x 13	schwarz	600-1e202b
PROFIL		2000 x 22 x 13	aluminium eloxiert	600-1e202s
INFORMATION	DETAIL	MATERIAL	FARBE	ART.NR.
ENDKAPPEN (Set 2 Stk.)		KUNSTSTOFF	weiß	600-1eek202w
ENDKAPPEN (Set 2 Stk.)		KUNSTSTOFF	schwarz	600-1eek202b
ENDKAPPEN (Set 2 Stk.)		KUNSTSTOFF	silber	600-1eek202s
INFORMATION	DETAIL	MATERIAL	FARBE	ART.NR.
ABDECKUNG		PMMA WEISS OPAL	weiß opal	600-1c202
ABDECKUNG		PMMA SCHWARZ OPAL	schwarz opal	600-cb202
INFORMATION	DETAIL	MATERIAL	FARBE	ART.NR.
MONTAGECLIPS (2 Stk.)		EDELSTAHL	EDELSTAHL	600-emc202





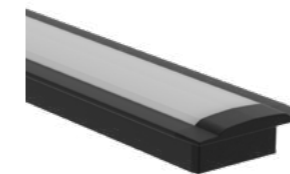

### MINI 17 EINBAU







Einbauprofil MINI 17 für LED Flexbänder bis Breite 12mm, HINWEIS: für LED Bänder bis max. 18 Watt, ET: 11mm, Ausschnitt: B: 19mm; Bei Verwendung von Endkappen: Profillänge + 4mm





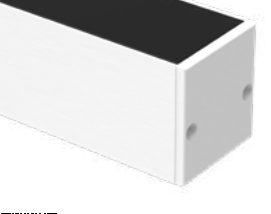

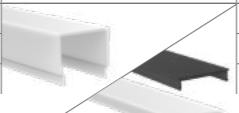

INFORMATION	DETAIL	L x B x H (mm)	FARBE	ART.NR.
PROFIL		2000 x 24 x 9	weiß	600-e203w
PROFIL		2000 x 24 x 9	schwarz	600-e203b
PROFIL		2000 x 24 x 9	aluminium eloxiert	600-e203s
INFORMATION	DETAIL	MATERIAL	FARBE	ART.NR.
ENDKAPPEN (Set 2 Stk.)		KUNSTSTOFF	weiß	600-eek203w
ENDKAPPEN (Set 2 Stk.)		KUNSTSTOFF	schwarz	600-eek203b
ENDKAPPEN (Set 2 Stk.)		KUNSTSTOFF	silber	600-eek203s
INFORMATION	DETAIL	MATERIAL	FARBE	ART.NR.
ABDECKUNG		PMMA WEISS OPAL	weiß opal	600-c203
INFORMATION	DETAIL	MATERIAL	FARBE	ART.NR.
MONTAGECLIPS (2 Stk.)		EDELSTAHL	EDELSTAHL	600-mc203

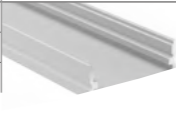
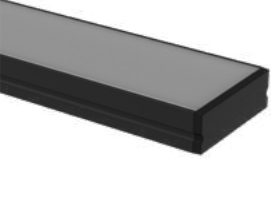







## AUFBAUPROFILE AUS ALUMINIUM FÜR LED STRIPES

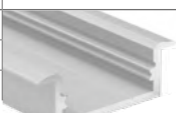
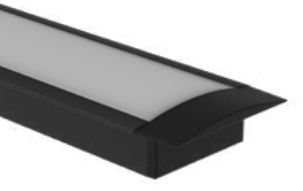







MIDI AUFBAU	INFORMATION	DETAIL	L x B x H (mm)	FARBE	ART.NR.
Aufbauprofil MIDI für LED Flexbänder bis Breite 15mm, HINWEIS: für LED Bänder bis max. 28 Watt	PROFIL		2000 x 23 x 11,2	weiß	600-a204w
	PROFIL		2000 x 23 x 11,2	schwarz	600-a204b
	PROFIL		2000 x 23 x 11,2	aluminium eloxiert	600-a204s
	INFORMATION	DETAIL	MATERIAL	FARBE	ART.NR.
	ENDKAPPEN (Set 2 Stk.)		KUNSTSTOFF	weiß	600-ae204w
	ENDKAPPEN (Set 2 Stk.)		KUNSTSTOFF	schwarz	600-ae204b
ENDKAPPEN (Set 2 Stk.)	KUNSTSTOFF		silber	600-ae204s	
	INFORMATION	DETAIL	MATERIAL	FARBE	ART.NR.
	ABDECKUNG		PMMA WEISS OPAL	weiß opal	600-c204
ABDECKUNG	PMMA SCHWARZ OPAL		schwarz opal	600-ck204	
	INFORMATION	DETAIL	MATERIAL	FARBE	ART.NR.
	MONTAGECLIPS (2 Stk.)		EDELSTAHL	EDELSTAHL	600-mc204

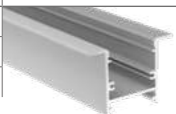

MAXI AUFBAU	INFORMATION	DETAIL	L x B x H (mm)	FARBE	ART.NR.
Aufbauprofil MAXI für LED Flexbänder bis Breite 15mm, HINWEIS: für LED Bänder bis max. 28 Watt	PROFIL		2000 x 23 x 25	weiß	600-a205w
	PROFIL		2000 x 23 x 25	schwarz	600-a205b
	PROFIL		2000 x 23 x 25	aluminium eloxiert	600-a205s
	INFORMATION	DETAIL	MATERIAL	FARBE	ART.NR.
	ENDKAPPEN (Set 2 Stk.)		KUNSTSTOFF	weiß	600-ae205w
	ENDKAPPEN (Set 2 Stk.)		KUNSTSTOFF	schwarz	600-ae205b
ENDKAPPEN (Set 2 Stk.)	KUNSTSTOFF		silber	600-ae205s	
	INFORMATION	DETAIL	MATERIAL	FARBE	ART.NR.
	ENDKAPPEN (Set 2 Stk.)		KUNSTSTOFF (H 25 mm)	weiß	600-ae205w
	ENDKAPPEN (Set 2 Stk.)		KUNSTSTOFF (H 25 mm)	schwarz	600-ae205b
ENDKAPPEN (Set 2 Stk.)	KUNSTSTOFF (H 25 mm)		silber	600-ae205s	
	INFORMATION	DETAIL	MATERIAL	FARBE	ART.NR.
	ABDECKUNG FLACH		PMMA WEISS OPAL	weiß opal	600-c205
	ABDECKUNG KUBISCH		PMMA WEISS OPAL	weiß opal	600-cu205
ABDECKUNG FLACH	PMMA SCHWARZ OPAL		schwarz opal	600-cb205	
	INFORMATION	DETAIL	MATERIAL	FARBE	ART.NR.
	MONTAGECLIPS (2 Stk.)		EDELSTAHL	EDELSTAHL	600-amc205

MEGA AUFBAU	INFORMATION	DETAIL	L x B x H (mm)	FARBE	ART.NR.
Aufbauprofil MEGA für LED Flexbänder bis Breite 15mm, HINWEIS: für LED Bänder bis max. 28 Watt	PROFIL		2000 x 30 x 10,1	weiß	600-a206w
	PROFIL		2000 x 30 x 10,1	schwarz	600-a206b
	PROFIL		2000 x 30 x 10,1	aluminium eloxiert	600-a206s
	INFORMATION	DETAIL	MATERIAL	FARBE	ART.NR.
	ENDKAPPEN (Set 2 Stk.)		KUNSTSTOFF	weiß	600-ae206w
	ENDKAPPEN (Set 2 Stk.)		KUNSTSTOFF	schwarz	600-ae206b
ENDKAPPEN (Set 2 Stk.)	KUNSTSTOFF		silber	600-ae206s	
	INFORMATION	DETAIL	MATERIAL	FARBE	ART.NR.
	ABDECKUNG		PMMA WEISS OPAL	weiß opal	600-c206
	INFORMATION		DETAIL	MATERIAL	FARBE
	MONTAGECLIPS (2 Stk.)		EDELSTAHL	EDELSTAHL	600-amc206

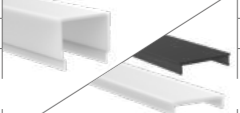
## EINBAUPROFILE AUS ALUMINIUM FÜR LED STRIPES

MIDI EINBAU	INFORMATION	DETAIL	L x B x H (mm)	FARBE	ART.NR.
Einbauprofil MIDI für LED Flexbänder bis Breite 15mm, HINWEIS: für LED Bänder bis max. 28 Watt, ET: 15mm, Ausschnitt: B: 24mm, Bei Verwendung von Endkappen: Profillänge + 4mm	PROFIL		2000 x 30 x 11,2	weiß	600-e204w
	PROFIL		2000 x 30 x 11,2	schwarz	600-e204b
	PROFIL		2000 x 30 x 11,2	aluminium eloxiert	600-e204s
	INFORMATION	DETAIL	MATERIAL	FARBE	ART.NR.
	ENDKAPPEN (Set 2 Stk.)		KUNSTSTOFF	weiß	600-ee204w
	ENDKAPPEN (Set 2 Stk.)		KUNSTSTOFF	schwarz	600-ee204b
ENDKAPPEN (Set 2 Stk.)	KUNSTSTOFF		silber	600-ee204s	
	INFORMATION	DETAIL	MATERIAL	FARBE	ART.NR.
	ABDECKUNG		PMMA WEISS OPAL	weiß opal	600-c204
ABDECKUNG	PMMA KLAR		klar	600-ck204	
	INFORMATION	DETAIL	MATERIAL	FARBE	ART.NR.
	MONTAGECLIPS (2 Stk.)		EDELSTAHL	EDELSTAHL	600-mc204
	INFORMATION		DETAIL	MATERIAL	FARBE
	MONTAGECLIPS (2 Stk.)		EDELSTAHL	EDELSTAHL	600-emc204

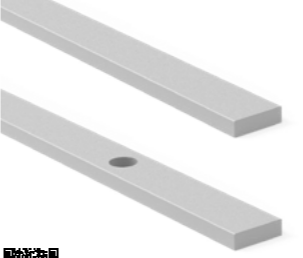







MAXI EINBAU	INFORMATION	DETAIL	L x B x H (mm)	FARBE	ART.NR.
Einbauprofil MAXI für LED Flexbänder bis Breite 15mm, HINWEIS: für LED Bänder bis max. 28 Watt, ET: 28mm, Ausschnitt: B: 24mm, Bei Verwendung von Endkappen: Profillänge + 4mm	PROFIL		2000 x 37 x 25	weiß	600-e205w
	PROFIL		2000 x 37 x 25	schwarz	600-e205b
	PROFIL		2000 x 37 x 25	aluminium eloxiert	600-e205s
	INFORMATION	DETAIL	MATERIAL	FARBE	ART.NR.
	ENDKAPPEN (Set 2 Stk.)		KUNSTSTOFF	weiß	600-ee205w
	ENDKAPPEN (Set 2 Stk.)		KUNSTSTOFF	schwarz	600-ee205b
ENDKAPPEN (Set 2 Stk.)	KUNSTSTOFF		silber	600-ee205s	
	INFORMATION	DETAIL	MATERIAL	FARBE	ART.NR.
	ENDKAPPEN (Set 2 Stk.)		KUNSTSTOFF (H 25 mm)	weiß	600-ee205w
	ENDKAPPEN (Set 2 Stk.)		KUNSTSTOFF (H 25 mm)	schwarz	600-ee205b
ENDKAPPEN (Set 2 Stk.)	KUNSTSTOFF (H 25 mm)		silber	600-ee205s	
	INFORMATION	DETAIL	MATERIAL	FARBE	ART.NR.
	ABDECKUNG FLACH		PMMA WEISS OPAL	weiß opal	600-c205
	ABDECKUNG KUBISCH		PMMA WEISS OPAL	weiß opal	600-cu205
ABDECKUNG FLACH	PMMA SCHWARZ OPAL		schwarz opal	600-cb205	
	INFORMATION	DETAIL	MATERIAL	FARBE	ART.NR.
	MONTAGECLIPS (2 Stk.)		EDELSTAHL	EDELSTAHL	600-emc205

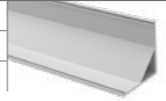





ZUBEHÖR	INFORMATION	L x B x H (mm)	FARBE	ART.NR.
	ALUSTREIFEN	1000 x 10 x 3	aluminium natur	600-1000
	ALUSTREIFEN MIT BOHRUNGEN	1000 x 10 x 3	aluminium natur	600-1000b
	INFORMATION	MATERIAL	FARBE	ART.NR.
	ALUSTREIFEN	3000 x 10 x 3	aluminium natur	600-3000
ALUSTREIFEN MIT BOHRUNGEN	3000 x 10 x 3	aluminium natur	600-3000b	





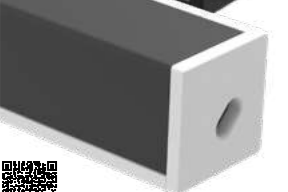
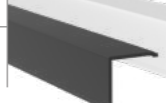



## ECKPROFILE AUS ALUMINIUM FÜR LED STRIPES



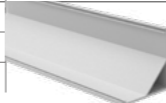
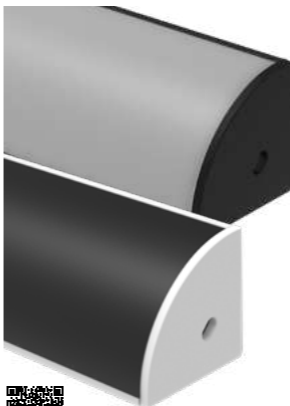

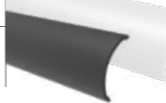

MINI CORNER AUFBAU	INFORMATION	DETAIL	L x B x H (mm)	FARBE	ART.NR.
Aufbauprofil MINI CORNER für LED Flexbänder bis Breite 8mm, HINWEIS: für LED Bänder bis max. 12 Watt	PROFIL		2000 x 18,5 x 18,5	weiß	600-a209w
	PROFIL		2000 x 18,5 x 18,5	schwarz	600-a209b
	PROFIL		2000 x 18,5 x 18,5	aluminium eloxiert	600-a209s
	INFORMATION	DETAIL	MATERIAL	FARBE	ART.NR.
	ENDKAPPEN (Set 2 Stk.)		KUNSTSTOFF	weiß	600-ae209w
	ENDKAPPEN (Set 2 Stk.)		KUNSTSTOFF	schwarz	600-ae209b
ENDKAPPEN (Set 2 Stk.)	KUNSTSTOFF		silber	600-ae209s	
	INFORMATION	DETAIL	MATERIAL	FARBE	ART.NR.
	ABDECKUNG		PMMA WEISS OPAL	weiß opal	600-c209
	INFORMATION	DETAIL	MATERIAL	FARBE	ART.NR.
	MONTAGECLIPS (2 Stk.)		EDELSTAHL	EDELSTAHL	600-amc209

MIDI CORNER AUFBAU	INFORMATION	DETAIL	L x B x H (mm)	FARBE	ART.NR.
Aufbauprofil MIDI CORNER für LED Flexbänder bis Breite 8mm, HINWEIS: für LED Bänder bis max. 9 Watt	PROFIL		2000 x 16 x 16	weiß	600-a207w
	PROFIL		2000 x 16 x 16	schwarz	600-a207b
	PROFIL		2000 x 16 x 16	aluminium eloxiert	600-a207s
	INFORMATION	DETAIL	MATERIAL	FARBE	ART.NR.
	ENDKAPPEN (Set 2 Stk.)		KUNSTSTOFF	weiß	600-ae207w
	ENDKAPPEN (Set 2 Stk.)		KUNSTSTOFF	schwarz	600-ae207b
ENDKAPPEN (Set 2 Stk.)	KUNSTSTOFF		silber	600-ae207s	
	INFORMATION	DETAIL	MATERIAL	FARBE	ART.NR.
	ABDECKUNG		PMMA WEISS OPAL	weiß opal	600-cr207
	INFORMATION	DETAIL	MATERIAL	FARBE	ART.NR.
	ABDECKUNG		PMMA SCHWARZ OPAL	schwarz opal	600-crb207
	INFORMATION	DETAIL	MATERIAL	FARBE	ART.NR.
	MONTAGECLIPS (2 Stk.)		EDELSTAHL	EDELSTAHL	600-amc207

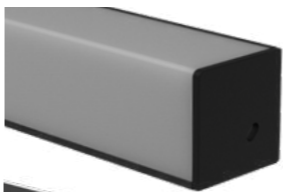

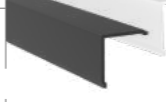

MIDI CORNER AUFBAU	INFORMATION	DETAIL	L x B x H (mm)	FARBE	ART.NR.
Aufbauprofil MIDI CORNER für LED Flexbänder bis Breite 8mm, HINWEIS: für LED Bänder bis max. 9 Watt	PROFIL		2000 x 16 x 16	weiß	600-a207w
	PROFIL		2000 x 16 x 16	schwarz	600-a207b
	PROFIL		2000 x 16 x 16	aluminium eloxiert	600-a207s
	INFORMATION	DETAIL	MATERIAL	FARBE	ART.NR.
	ENDKAPPEN (Set 2 Stk.)		KUNSTSTOFF	weiß	600-ae207w
	ENDKAPPEN (Set 2 Stk.)		KUNSTSTOFF	schwarz	600-ae207b
ENDKAPPEN (Set 2 Stk.)	KUNSTSTOFF		silber	600-ae207s	
	INFORMATION	DETAIL	MATERIAL	FARBE	ART.NR.
	ABDECKUNG		PMMA WEISS OPAL	weiß opal	600-c207
	INFORMATION	DETAIL	MATERIAL	FARBE	ART.NR.
	ABDECKUNG		PMMA SCHWARZ OPAL	schwarz opal	600-cb207
	INFORMATION	DETAIL	MATERIAL	FARBE	ART.NR.
	MONTAGECLIPS (2 Stk.)		EDELSTAHL	EDELSTAHL	600-amc207





## ECKPROFILE AUS ALUMINIUM FÜR LED STRIPES





MAXI CORNER AUFBAU	INFORMATION	DETAIL	L x B x H (mm)	FARBE	ART.NR.
Aufbauprofil MAXI CORNER für LED Flexbänder bis Breite 15mm, HINWEIS: für LED Bänder bis max. 28 Watt	PROFIL		2000 x 30 x 30	weiß	600-a208w
	PROFIL		2000 x 30 x 30	schwarz	600-a208b
	PROFIL		2000 x 30 x 30	aluminium eloxiert	600-a208s
	INFORMATION	DETAIL	MATERIAL	FARBE	ART.NR.
	ENDKAPPEN (Set 2 Stk.)		KUNSTSTOFF	weiß	600-ae208w
	ENDKAPPEN (Set 2 Stk.)		KUNSTSTOFF	schwarz	600-ae208b
ENDKAPPEN (Set 2 Stk.)	KUNSTSTOFF		silber	600-ae208s	
	INFORMATION	DETAIL	MATERIAL	FARBE	ART.NR.
	ABDECKUNG		PMMA WEISS OPAL	weiß opal	600-cr208
	INFORMATION	DETAIL	MATERIAL	FARBE	ART.NR.
	ABDECKUNG		PMMA SCHWARZ OPAL	schwarz opal	600-crb208
	INFORMATION	DETAIL	MATERIAL	FARBE	ART.NR.
	MONTAGECLIPS (2 Stk.)		EDELSTAHL	EDELSTAHL	600-amc208

MAXI CORNER AUFBAU	INFORMATION	DETAIL	L x B x H (mm)	FARBE	ART.NR.
Aufbauprofil MAXI CORNER für LED Flexbänder bis Breite 15mm, HINWEIS: für LED Bänder bis max. 28 Watt	PROFIL		2000 x 30 x 30	weiß	600-a208w
	PROFIL		2000 x 30 x 30	schwarz	600-a208b
	PROFIL		2000 x 30 x 30	aluminium eloxiert	600-a208s
	INFORMATION	DETAIL	MATERIAL	FARBE	ART.NR.
	ENDKAPPEN (Set 2 Stk.)		KUNSTSTOFF	weiß	600-ae208w
	ENDKAPPEN (Set 2 Stk.)		KUNSTSTOFF	schwarz	600-ae208b
ENDKAPPEN (Set 2 Stk.)	KUNSTSTOFF		silber	600-ae208s	
	INFORMATION	DETAIL	MATERIAL	FARBE	ART.NR.
	ABDECKUNG		PMMA WEISS OPAL	weiß opal	600-c208
	INFORMATION	DETAIL	MATERIAL	FARBE	ART.NR.
	ABDECKUNG		PMMA SCHWARZ OPAL	schwarz opal	600-cb208
	INFORMATION	DETAIL	MATERIAL	FARBE	ART.NR.
	MONTAGECLIPS (2 Stk.)		EDELSTAHL	EDELSTAHL	600-amc208

## AUFBAUPROFILES AUS ALUMINIUM FÜR LED STRIPE

FLEX AUFBAU	INFORMATION	DETAIL	L x B x H (mm)	FARBE	ART.NR.
Aufbauprofil FLEX für LED Flexbänder bis Breite 12mm, HINWEIS: für LED Bänder bis max. 9 Watt	PROFIL max. Biegeradius: 200 mm		2000 x 17,8 x 5,1	aluminium eloxiert	600-a212s
	INFORMATION	DETAIL	MATERIAL	FARBE	ART.NR.
	ENDKAPPEN (Set 2 Stk.)		KUNSTSTOFF	silber	600-aek212s
	INFORMATION	DETAIL	MATERIAL	FARBE	ART.NR.
	ABDECKUNG max. Biegeradius: 200 mm		PMMA WEISS OPAL	weiß opal	600-c212
INFORMATION	DETAIL	MATERIAL	FARBE	ART.NR.	
MONTAGECLIPS (2 Stk.)		EDELSTAHL	EDELSTAHL	600-amc212	

MIDI CUBE AUFBAU	INFORMATION	DETAIL	L x B x H (mm)	FARBE	ART.NR.
Aufbauprofil MIDI CUBE für LED Flexbänder bis Breite 12mm, HINWEIS: für LED Bänder bis max. 15 Watt	PROFIL		2000 x 20 x 27	weiß	600-a211w
	PROFIL		2000 x 20 x 27	schwarz	600-a211b
	PROFIL		2000 x 20 x 27	aluminium eloxiert	600-a211s
	INFORMATION	DETAIL	MATERIAL	FARBE	ART.NR.
	ENDKAPPEN (Set 2 Stk.)		KUNSTSTOFF	weiß	600-aek211w
	ENDKAPPEN (Set 2 Stk.)		KUNSTSTOFF	schwarz	600-aek211b
	ENDKAPPEN (Set 2 Stk.)		KUNSTSTOFF	silber	600-aek211s
	INFORMATION	DETAIL	MATERIAL	FARBE	ART.NR.
	ABDECKUNG		PMMA WEISS OPAL	weiß opal	600-c211
	INFORMATION	DETAIL	MATERIAL	FARBE	ART.NR.
MONTAGECLIPS (2 Stk.)		EDELSTAHL	EDELSTAHL	600-amc211	

MAXI SOFT AUFBAU	INFORMATION	DETAIL	L x B x H (mm)	FARBE	ART.NR.
Aufbauprofil MAXI CUBE SOFT für LED Flexbänder bis Breite 18mm, HINWEIS: für LED Bänder bis max. 12 Watt	PROFIL		2000 x 26,7 x 24,4	weiß	600-a210w
	PROFIL		2000 x 26,7 x 24,4	schwarz	600-a210b
	PROFIL		2000 x 26,7 x 24,4	aluminium eloxiert	600-a210s
	INFORMATION	DETAIL	MATERIAL	FARBE	ART.NR.
	ENDKAPPEN (Set 2 Stk.)		KUNSTSTOFF	weiß	600-aek210w
	ENDKAPPEN (Set 2 Stk.)		KUNSTSTOFF	schwarz	600-aek210b
	ENDKAPPEN (Set 2 Stk.)		KUNSTSTOFF	silber	600-aek210s
	INFORMATION	DETAIL	MATERIAL	FARBE	ART.NR.
	ABDECKUNG		PMMA WEISS OPAL	weiß opal	600-c210
	INFORMATION	DETAIL	MATERIAL	FARBE	ART.NR.
MONTAGECLIPS (2 Stk.)		EDELSTAHL	EDELSTAHL	600-amc210	

## RIDE PROFILE AUS ALUMINIUM FÜR LED STRIPES

RIDE AUFBAUPROFIL	INFORMATION	L x B x H (mm)	FARBE	ART.NR.
LED Aufbauprofil RIDE aus stranggepresstem Aluminium, geeignet für LED Flexbänder, in den Farben Aluminium eloxiert, schwarz oder weiß pulverbeschichtet erhältlich, Enddeckel und Abdeckungen separat ordern.	PROFIL	2000 x 35 x 35	weiß	577-125leer
	PROFIL	2000 x 35 x 35	schwarz	577-126leer
	PROFIL	2000 x 35 x 35	aluminium eloxiert	577-128leer
	PROFIL	4500 x 35 x 35	weiß	577-41005
	PROFIL	4500 x 35 x 35	schwarz	577-41006
	PROFIL	4500 x 35 x 35	aluminium eloxiert	577-41008
	INFORMATION	MATERIAL / AUSFÜHRUNG	FARBE	ART.NR.
	ENDKAPPEN (Set 2 Stk.)	KUNSTSTOFF/Abdeckung flach	weiß	577-4605
	ENDKAPPEN (Set 2 Stk.)	KUNSTSTOFF/Abdeckung flach	schwarz	577-4606
	ENDKAPPEN (Set 2 Stk.)	KUNSTSTOFF/Abdeckung flach	silber	577-4604
ENDKAPPEN (Set 2 Stk.)	KUNSTSTOFF/Abdeckung kubisch	weiß	577-4625	
ENDKAPPEN (Set 2 Stk.)	KUNSTSTOFF/Abdeckung kubisch	schwarz	577-4626	
ENDKAPPEN (Set 2 Stk.)	KUNSTSTOFF/Abdeckung kubisch	silber	577-4624	

RIDE EINBAUPROFIL	INFORMATION	L x B x H (mm)	FARBE	ART.NR.
LED Einbauprofil RIDE aus stranggepresstem Aluminium, geeignet für LED Flexbänder, in den Farben Aluminium eloxiert, schwarz oder weiß pulverbeschichtet erhältlich, Enddeckel und Abdeckung separat ordern. ET: 75mm, Ausschnitt B: 37mm, Länge Profil - 3mm, Nur flache Abdeckung möglich	PROFIL	2000 x 44 x 35 x 75	weiß	577-225leer
	PROFIL	2000 x 44 x 35 x 75	schwarz	577-226leer
	PROFIL	2000 x 44 x 35 x 75	aluminium eloxiert	577-228leer
	PROFIL	4500 x 44 x 35 x 75	weiß	577-41105
	PROFIL	4500 x 44 x 35 x 75	schwarz	577-41106
	PROFIL	4500 x 44 x 35 x 75	aluminium eloxiert	577-41108
	INFORMATION	MATERIAL / AUSFÜHRUNG	FARBE	ART.NR.
	ENDKAPPEN (Set 2 Stk.)	KUNSTSTOFF/Abdeckung flach	weiß	577-4705
	ENDKAPPEN (Set 2 Stk.)	KUNSTSTOFF/Abdeckung flach	schwarz	577-4706
	ENDKAPPEN (Set 2 Stk.)	KUNSTSTOFF/Abdeckung flach	silber	577-4704
INFORMATION	MATERIAL / AUSFÜHRUNG	FARBE	ART.NR.	
MONTAGESET	KUNSTSTOFF/Abdeckung kubisch	schwarz	577-5000	

ABDECKUNG FÜR RIDE PROFIL	INFORMATION	L x B x H (mm)	FARBE	ART.NR.
Abdeckung aus opalem PMMA, für Einbauprofil RIDE nur die flache Abdeckung ordern	ABDECKUNG FLACH	2000 x 35 x 2	weiß opal	577-20pm
	ABDECKUNG KUBISCH	2000 x 35 x 35	weiß opal	577-20pmk
	ABDECKUNG FLACH	4500 x 35 x 2	weiß opal	577-42100
	ABDECKUNG KUBISCH	4500 x 35 x 35	weiß opal	577-42200

VERBINDER FÜR RIDE PROFIL	INFORMATION	ART.NR.
LINEARVERBINDER		577-4300
ECKVERBINDER FÜR HORIZONTALE LICHTLÖSUNGEN		577-4400
ECKVERBINDER FÜR VERTIKALE LICHTLÖSUNGEN		577-4410

## KONSTANTSPANNUNGSKONVERTER



LED KONVERTER SLIM/U	INFORMATION	WATT	V DC	V AC	L x B x H (mm)	FARBE	ART.NR.
	LED Konverter für LED Stripes nicht dimmbar, schaltbar	13W	24	230	158 x 22 x 19	weiß	24-122442
							
LED KONVERTER EFU	INFORMATION	WATT	V DC	V AC	L x B x H (mm)	FARBE	ART.NR.
	LED Konverter für LED Stripes nicht dimmbar, schaltbar	25W	24	230	146 x 55 x 19	weiß	24-122322
							
LED KONVERTER LCV	INFORMATION	WATT	V DC	V AC	L x B x H (mm)	FARBE	ART.NR.
	LED Konverter für LED Stripes nicht dimmbar, schaltbar	60W	24	230	180 x 52 x 30	weiß	24-127821
		120W	24	230	300 x 40 x 30	weiß	24-127824
							
LED KONVERTER VPS LP	INFORMATION	WATT	V DC	V AC	L x B x H (mm)	FARBE	ART.NR.
	LED Konverter für LED Stripes nicht dimmbar, schaltbar	50W	24	230	167 x 59 x 28,5	weiß	24-127903
		75W	24	230	184 x 61 x 28,5	weiß	24-127905
							
LED KONVERTER VST	INFORMATION	WATT	V DC	V AC	L x B x H (mm)	FARBE	ART.NR.
	LED Konverter für LED Stripes nicht dimmbar, schaltbar	50W	24	230	225 x 60 x 36	weiß	24-122752
		75W	24	230	225 x 60 x 36	weiß	24-122750
		150W	24	230	240 x 60 x 49	schwarz	24-122754n
							
LED KONVERTER ST2 IP67	INFORMATION	WATT	V DC	V AC	L x B x H (mm)	FARBE	ART.NR.
	LED Konverter für LED Stripes nicht dimmbar, schaltbar	70W	24	230	225 x 66 x 51	schwarz	24-122479
		150W	24	230	225 x 66 x 51	schwarz	24-122511
							
KONVERTER ELG IP67	INFORMATION	W	V DC	L x B x H	FARBE	ART.NR.	
	Überlastschutz durch Strombegrenzung geschützt gegen Kurzschluss mit automatischen Wiederanlauf, Überlast, Überspannung eingebauter aktiver PFC-Schaltkreis, 240W, 24V	240	24	244 x 71 x 38	grau	647-elg24024	

## KONSTANTSPANNUNGSKONVERTER DIMMBAR



LED KONVERTER VSTR 1-10V / PUSH / IR	INFORMATION	WATT	V DC	V AC	L x B x H (mm)	FARBE	ART.NR.
	LED-Konverter für LED Stripes, dimmbar 1-10V & Push Dimm., IR-Zubehör separat ordern (IR-Empfänger inkl. 2m Kabel 24-122093 + IR-Fernbedienung 24-150120A)	3x 40W RGB 1x 100W weiß	24	230	240 x 60 x 49	weiß	24-122730
							
DALI DT8 / PUSH LED KONVERTER	INFORMATION	WATT	V DC	V AC	L x B x H (mm)	FARBE	ART.NR.
	LED-Konverter für LED Stripes, dimmbar DALI DT8 Push Dimm. 2 KANAL	75W	24	230	486 x 31 x 21	graphit	711-24752dt8
							
DALI / PUSH LED KONVERTER	INFORMATION	WATT	V DC	V AC	L x B x H (mm)	FARBE	ART.NR.
	LED-Konverter für LED Stripes, dimmbar DALI Push Dimm. 2 KANAL	30W	24	230	170 x 54 x 28	weiß	711-24302dt6
							
DALI / PUSH LED KONVERTER	INFORMATION	WATT	V DC	V AC	L x B x H (mm)	FARBE	ART.NR.
	LED-Konverter für LED Stripes, dimmbar DALI Push Dimm. 1 KANAL	150W	24	230	365 x 43 x 30	weiß	711-241501dt6
							
LED KONVERTER QT DALI	INFORMATION	WATT	V DC	V AC	L x B x H (mm)	FARBE	ART.NR.
	LED Konverter für LED Stripes DALI dimmbar	50W	24	230	346 x 32 x 22	weiß	28-177900
		80W	24	230	346 x 32 x 22	weiß	28-177924
		160W	24	230	300 x 50 x 35	weiß	28-177948
							
UNIVERSALDIMMER	INFORMATION	V DC	L x B x H (mm)	FARBE	ART.NR.		
	Universaldimmer 1 Kanal, separater Steuereingang für DALI, 1-10V, Push, Sync Anschluß für bis zu 9 Slaves bei 1-10V oder Push Ansteuerung, max. Anschluß: 5A Zugenlastung separat ordern <b>ZUGENLASTUNG</b> für 1-Kanal Universaldimmer, 2 Stück	12-50	153 x 30 x 21	weiß	322-ud3000		
					322-ud7001		
							
DALI DT8 / PUSH LED DIMMER - 4 KANAL	INFORMATION	WATT	V DC	V AC	L x B x H (mm)	FARBE	ART.NR.
	Dimmer für LED Stripes, DALI DT8 für RGB/W und tunable white, Konverter separat ordern	60-180W	12-36	230	170 x 54 x 28	weiß	711-24180dt8
							

## LICHTSZENEKONTROLLER

DALI DT8 RGBW - TOUCHPANEL	INFORMATION	V AC	L x B x H	FARBE	ART.NR.
	Lichtszenenkontroller DALI DT8 für RGB/W LED Stripes, 4 Szenen konfigurierbar, zur Montage in Standard-Einbaudose Ø 68mm	230	86 x 86 x 41	weiß	711-01230d8rgbw

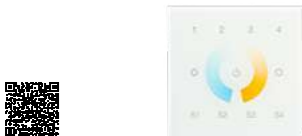
DALI DT8 TUNABLE WHITE - TOUCHPANEL	INFORMATION	V AC	L x B x H	FARBE	ART.NR.
	Lichtszenenkontroller DALI DT8 für tunable white LED Stripes, 4 Szenen konfigurierbar, zur Montage in Standard-Einbaudose Ø 68mm	230	86 x 86 x 41	weiß	711-01230d8tw

## BLUETOOTHSTEUERUNG

PUSH BUTTON INTERFACE	INFORMATION	V AC	L x B x H	FARBE	ART.NR.
	Zur Integration von handelsüblichen Tastern in die MOLTO LUCE Smart App BLUETOOTH Dimm. 3 Kanal UP-Dosenmodul	230	43 x 43 x 18	blau	701-1005

BLUETOOTH DIMMER-2 KANAL	INFORMATION	W	V DC	V AC	L x B x H	FARBE	ART.NR.
	SED DCC 2CH BLL Konverter, PWM-dimmbar, Draht Querschnitt bis zu 2,5mm, Schutz gegen Überhitzung und Kurzschluss, Netzüberspannungen, Überlast, Deckeneinlegeausschnitt=40mm, V out = 2 x 24V DC, 4,5A	2x 50W 1x 100W	24	230	115 x 34 x 19	blau	701-1004

INTERFACE SMART BLUETOOTH TO DALI	INFORMATION	V AC	L x B x H	FARBE	ART.NR.
	Zur Integration von max. 40 Dali dimmbaren Leuchte in die MOLTO LUCE Smart App, BLUETOOTH Dimm. Smart BLUETOOTH to DALI	230	85 x 30 x 22	blau	701-1003

MOLTO LUCE SMART APP	INFORMATION
----------------------	-------------

Die Molto Luce Smart APP ist ihr System zur Lichtsteuerung, egal ob einzelne Gruppen, ganze Netzwerke, Szenen, Zeitsteuerungen und komplexe Lösungen wie Heatmapping. Die Molto Luce Smart APP stellt ihnen alle Möglichkeiten zur Verfügung.  
**DOWNLOAD IM APP ODER PLAY STORE**





SMART APP BEDIENUNGSANLEITUNG:





## FUNK STEUERUNG

LED LICHTSZENEKONTROLLER	INFORMATION	FÜR	V DC	L x B x H (mm)	FARBE	ART.NR.
	RGBW Funk Controller für bis zu 4 Zonen, bis zu 4 Stimmungen, Geschwindigkeit und Helligkeit kann angepasst werden, Steuereinheit kann auf Standard EB-Dose 68mm montiert werden	WIFI / FUNK	12 - 24	86 x 86 x 10	schwarz	711-000606

FUNK FERNBEDIENUNG	INFORMATION	L x B x H (mm)	FARBE	ART.NR.
	Funk Fernbedienung mit Farbrad zur einfachen Tunable White Steuerung, 2 Lichtfarben können gespeichert werden, 2 Szenen-Wahl, Dimmstufen in 25% Schritten abrufbar	120 x 48 x 18	weiß	711-001106

FUNK FERNBEDIENUNG	INFORMATION	L x B x H (mm)	FARBE	ART.NR.
	Funk Fernbedienung für bis zu 4 Zonen, bis zu 4 Stimmungen, Geschwindigkeit und Helligkeit kann angepasst werden, inkl. Wandhalterung	140 x 48 x 16	schwarz	711-000506

FUNK FERNBEDIENUNG	INFORMATION	L x B x H (mm)	FARBE	ART.NR.
	Funk Fernbedienung für bis zu 5 Zonen zur Dimmung der Helligkeit, Fernbedienung kann mit bis zu 8 verschiedenen Empfängern arbeiten	136 x 39 x 11	schwarz	711-000906

WLAN GATEWAY	INFORMATION	V DC	L x B x H (mm)	FARBE	ART.NR.
	W-LAN Gateway, zur Ansteuerung von 711-000305, dazugehöriges App. EASYColor Pro im Appstore bzw. Playstore kostenlos erhältlich, Integration ins hauseigene WLAN möglich.	12 - 24	110 x 85 x 24	schwarz	711-000406

FUNK DIMMER RGBW	INFORMATION	WATT	V DC	L x B x H (mm)	FARBE	ART.NR.
	4-Kanal Funk Dimmer zur Ansteuerung von RGB/W, RGB oder weißen LED Stripes max. 5A/Kanal, Spannungsversorgung separat ordern	240 - 720W	12 - 36	179 x 46 x 19	weiß	711-000305

FUNK DIMMER TUNABLE WHITE	INFORMATION	WATT	V DC	L x B x H (mm)	FARBE	ART.NR.
	2-Kanal Funk Dimmer zur Ansteuerung von Tunable White LED Stripes max. 5A/Kanal, Spannungsversorgung separat ordern	110 - 240W	12 - 24	145 x 47 x 16	weiß	711-001005

## DMX STEUERUNG

DMX RGBW LED DIMMER	INFORMATION	V DC	L x B x H (mm)	FARBE	ART.NR.
	RGB/W LED Dimmer 12-36V DMX, 12V - 36V DC, geeignet zur Steuerung von RGBW LED Stripes, max. 5A / Kanal	12 - 36	178 x 46 x 18	weiß	711-000705

LED LICHTSZENEKONTROLLER	INFORMATION	FÜR	V DC	L x B x H (mm)	FARBE	ART.NR.
	Lichtszenenkontroller DMX für RGB/W Stripes, 4 Szenen konfigurierbar, zur Montage in Standard-Einbaudose Ø 68mm	DMX II	12 - 24	86 x 86 x 10	schwarz	711-000806

# EINBAULEUCHTEN AUSSSEN





**RADO R**

INFORMATION	LEISTUNG	mA	LUMEN	CRI>	KELVIN	Ø x ET	DA Ø	FARBE	ART.NR.
Einbaustrahler, Aluminium, schwarz lackiert, chrom oder perlchrom galvanisiert, rund, starr, facettierte Linse 30°, exkl. Konverter, Zubehör separat ordern	2W	500	162	90	3000	35 x 29	30	chrom	56-6111ng2
	2W	500	162	90	3000	35 x 29	30	perlchrom	56-6011ng2
	2W	500	162	90	3000	35 x 29	30	schwarz	56-6211ng2
<b>UNTERPUTZKLEMMDOSE INFO</b>	<b>ABBILDUNG</b>		<b>L x B x H x ET</b>		<b>ART.NR.</b>				
für Rado, DM 30mm, Achtung: nur LED Konverter der Serie 75-MPL passen in die Unterputzklemmdose			100 x 100 x 60 x 52		56-ak7530				
<b>BETONEINBAUHÜLSE INFO</b>	<b>ABBILDUNG</b>		<b>Ø x L</b>		<b>ART.NR.</b>				
Aluminium, für Rado			35 x 98		56-be9805				



KONVERTER	INFORMATION	WATT	mA	V DC	V AC	L x B x H	FARBE	ART.NR.
	nicht dimmbar	4W	500	54	230	51 x 32 x 18	schwarz	75-mpl5
	nicht dimmbar	20W	500	40	230	111 x 52 x 22	weiß	24-122201



**ZEPPELIN QUADRO**

INFORMATION	LEISTUNG	mA	LUMEN	CRI>	KELVIN	L x B x ET	Ø DA	FARBE	REFL.	ART.NR.	
starrer Einbaustrahler aus Stahl mit satinierem Schutzglas, begehbar bis 500kg, exkl. Konverter, Zubehör separat ordern.	LED 2W	500	199	80	3000	40 x 40 x 80	30 x 30	edelstahl	---	68-634933WW	
	<b>BODENEINBAUHÜLSE INFO</b>						<b>ABBILDUNG</b>		<b>Ø x ET</b>		<b>ART.NR.</b>
für Gipskarton WA Ø 32 mm, im Lieferumfang enthalten	Bodeneinbauhülse, Kunststoff, für Zeppelin, inkl. Verbinder IP67, Drainage erforderlich, exkl. Konverter								110 x 100		68-0220
<b>WANDEINBAUHÜLSE INFO</b>						<b>ABBILDUNG</b>		<b>Ø x ET</b>		<b>ART.NR.</b>	
Wandeneinbauhülse, Kunststoff, für Zeppelin								40 x 70		68-0216	



**ZEPPELIN TONDO**

INFORMATION	LEISTUNG	mA	LUMEN	CRI>	KELVIN	Ø x ET	DA Ø	FARBE	REFL.	ART.NR.	
starrer Einbaustrahler aus Stahl mit satinierem Schutzglas, begehbar bis 500kg, exkl. Konverter, Zubehör separat ordern.	LED 2W	500	199	80	3000	40 x 80	30	edelstahl	---	68-634833WW	
	<b>BODENEINBAUHÜLSE INFO</b>						<b>ABBILDUNG</b>		<b>Ø x ET</b>		<b>ART.NR.</b>
für Gipskarton WA Ø 32 mm, im Lieferumfang enthalten	Bodeneinbauhülse, Kunststoff, für Zeppelin, inkl. Verbinder IP67, Drainage erforderlich, exkl. Konverter								110 x 100		68-0220
<b>WANDEINBAUHÜLSE INFO</b>						<b>ABBILDUNG</b>		<b>Ø x ET</b>		<b>ART.NR.</b>	
Wandeneinbauhülse, Kunststoff, für Zeppelin								40 x 70		68-0216	



KONVERTER	INFORMATION	WATT	mA	V DC	V AC	L x B x H	FARBE	ART.NR.
	nicht dimmbar	6W	500	11,5	230	60 x 35 x 21,5	weiß	24-122602
	nicht dimmbar	20W	500	40	230	111 x 52 x 22	weiß	24-122201



### IVY SQUARE R

INFORMATION	LEISTUNG	mA	LUMEN	CRI>	KELVIN	L x B x ET	DA Ø	FARBE	REFL.	ART.NR.
Einbaustrahler, Aluminiumdruckguss, Feinstruktur matt pulverbeschichtet, quadratisch, runder Deckenausschnitt, starr, zurückversetzte Lichtquelle, exkl. Konverter	LED 7W	200	700	90	3000	72 x 72 x 94	60	weiß	20°	472-0270790203005
	LED 7W	200	660	90	3000	72 x 72 x 94	60	schwarz	20°	472-0270790203006
	LED 7W	200	640	90	3000	72 x 72 x 94	60	weiß	40°	472-0270790403005
	LED 7W	200	630	90	3000	72 x 72 x 94	60	schwarz	40°	472-0270790403006



KONVERTER IVY SQUARE	INFORMATION	WATT	mA	V DC	V AC	L x B x H	FARBE	ART.NR.
	nicht dimmbar	8,5W	200	44	230	147 x 44 x 22	weiß	24-127570
	DALI dimmbar	9,5W	180	53	230	111 x 52 x 22	weiß	24-123395

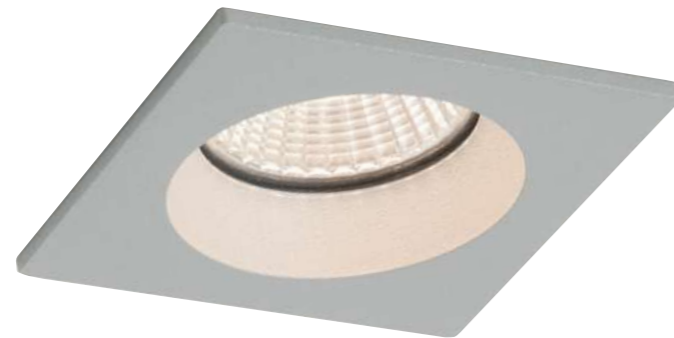

### CHICCO SQUARE

INFORMATION	LEISTUNG	mA	LUMEN	CRI>	KELVIN	L x B x ET	DA Ø	FARBE	REFL.	ART.NR.
Einbaustrahler, Aluminiumdruckguss, Feinstruktur matt pulverbeschichtet, starr, zurückversetzte Lichtquelle, 30° Ausstrahlwinkel, exkl. Konverter	LED 7W	350	530	90	2700	90 x 90 x 80	78	silber	30°	308-0020790302704
	LED 7W	350	540	90	2700	90 x 90 x 80	78	weiß	30°	308-0020790302705
	LED 7W	350	510	90	2700	90 x 90 x 80	78	schwarz	30°	308-0020790302706
	LED 7W	350	560	90	3000	90 x 90 x 80	78	silber	30°	308-0020790303004
	LED 7W	350	590	90	3000	90 x 90 x 80	78	weiß	30°	308-0020790303005
	LED 7W	350	560	90	3000	90 x 90 x 80	78	schwarz	30°	308-0020790303006



KONVERTER CHICCO	INFORMATION	WATT	mA	V DC	V AC	L x B x H	FARBE	ART.NR.
	nicht dimmbar	16W	350	46	230	147 x 44 x 33	weiß	24-127530n
	DALI dimmbar	17W	350	49	230	111 x 52 x 22	weiß	24-151403

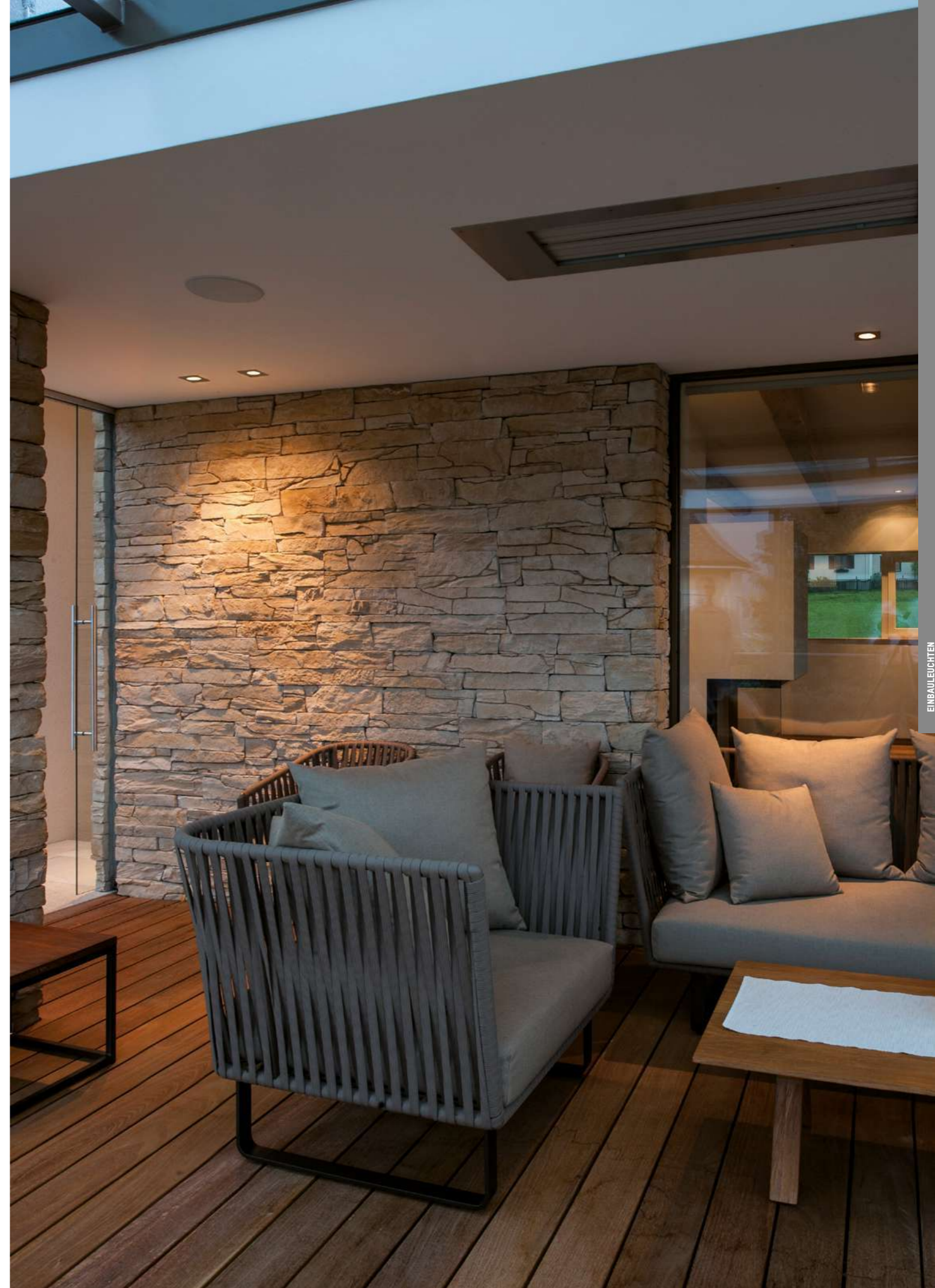

Projekt: Wohnhaus, Österreich, Foto: Molto Luce, Produkt: CHICCO SQUARE R



### IVY ROUND R

INFORMATION	LEISTUNG	mA	LUMEN	CRI>	KELVIN	Ø x ET	DA Ø	FARBE	REFL.	ART.NR.
Einbaustrahler, Aluminiumdruckguss, Feinstruktur matt pulverbeschichtet, rund, starr, mit zurückversetzter Lichtquelle, exkl. Konverter	LED 7W	200	700	90	3000	72 x 94	60	weiß	20°	472-0260790203005
	LED 7W	200	660	90	3000	72 x 94	60	schwarz	20°	472-0260790203006
	LED 7W	200	640	90	3000	72 x 94	60	weiß	40°	472-0260790403005
	LED 7W	200	630	90	3000	72 x 94	60	schwarz	40°	472-0260790403006



LED KONVERTER IVY SQUARE	INFORMATION	WATT	mA	V DC	V AC	L x B x H	FARBE	ART.NR.
	nicht dimmbar	8,5W	200	44	230	147 x 44 x 22	weiß	24-127570
	DALI dimmbar	9,5W	180	53	230	111 x 52 x 22	weiß	24-123395



### CHICCO ROUND

INFORMATION	LEISTUNG	mA	LUMEN	CRI>	KELVIN	Ø x ET	DA Ø	FARBE	REFL.	ART.NR.
Einbaustrahler, Aluminiumdruckguss Feinstruktur matt pulverbeschichtet, starr, zurückversetzte Lichtquelle, 30° Ausstrahlwinkel, exkl. Konverter	LED 7W	350	530	90	2700	90 x 80	78	silber	30°	308-0010790302704
	LED 7W	350	540	90	2700	90 x 80	78	weiß	30°	308-0010790302705
	LED 7W	350	510	90	2700	90 x 80	78	schwarz	30°	308-0010790302706
	LED 7W	350	560	90	3000	90 x 80	78	silber	30°	308-0010790303004
	LED 7W	350	590	90	3000	90 x 80	78	weiß	30°	308-0010790303005
	LED 7W	350	560	90	3000	90 x 80	78	schwarz	30°	308-0010790303006



LED KONVERTER CHICCO	INFORMATION	WATT	mA	V DC	V AC	L x B x H	FARBE	ART.NR.
	nicht dimmbar	16W	350	46	230	147 x 44 x 33	weiß	24-127530n
	DALI dimmbar	17W	350	49	230	111 x 52 x 22	weiß	24-151403

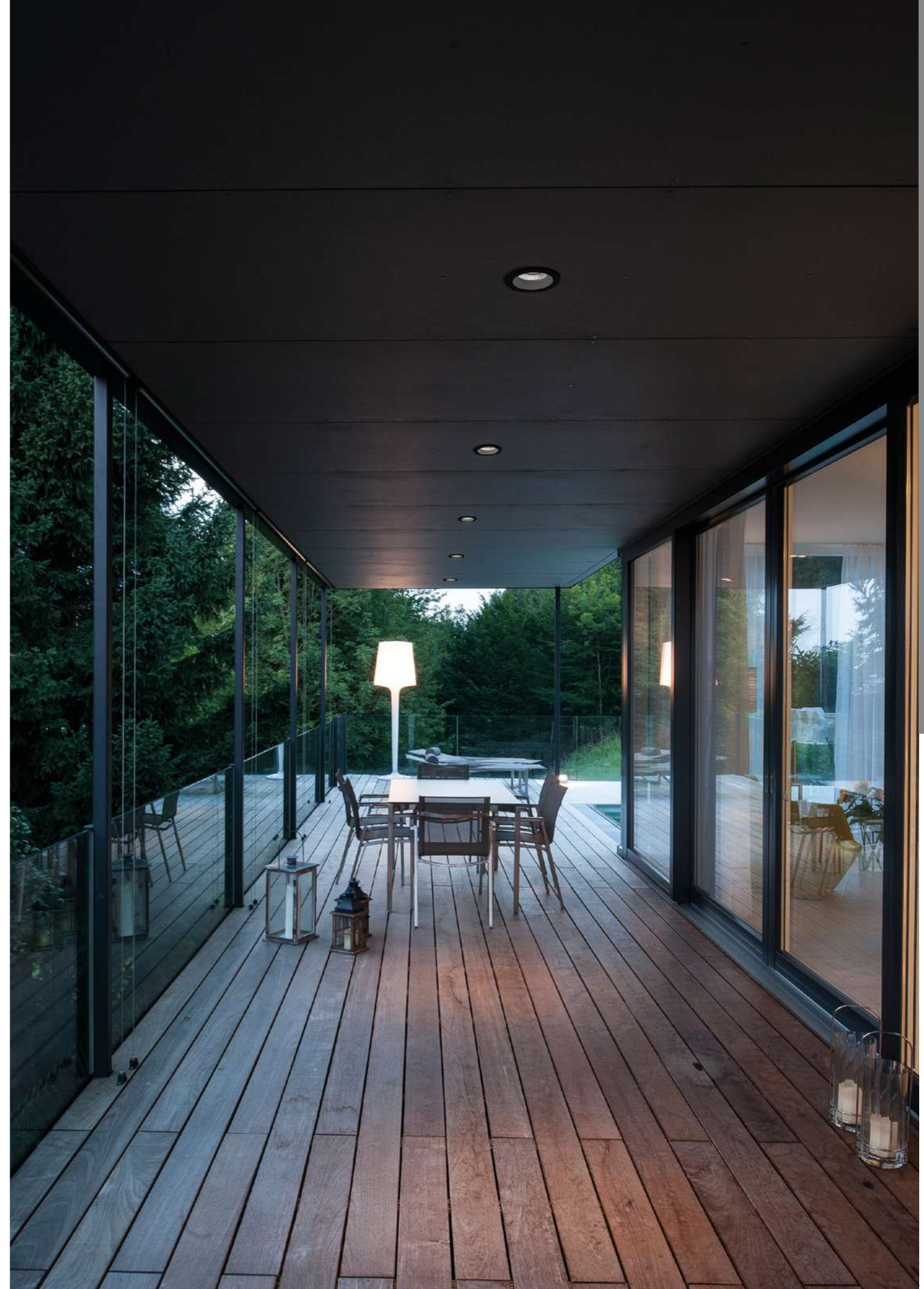

Projekt: Wohnhaus, Österreich, Foto: Molto Luce, Produkt: CHICCO ROUND R



# AUFBAULEUCHTEN AUSSEN



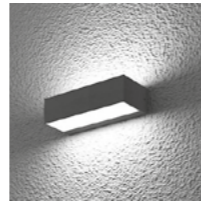
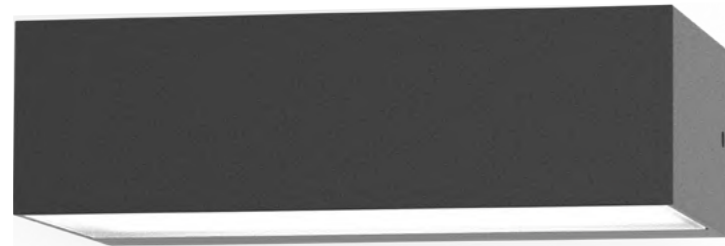

direkt / indirekt

### PARE W

INFORMATION	LEISTUNG	LUMEN	CRI>	KELVIN	L x H x T	FARBE	LICHTAUSTRITT	REFL.	ART.NR.
Wandleuchte, Aluminiumdruckguss, Feinstruktur matt pulverbeschichtet, satinierter Diffusor aus Polycarbonat für homogenen Lichteﬀekt, direkt/indirekt strahlend, inkl. Konverter	SYS 12W	380	80	3000	207 x 60 x 110	anthrazit	direkt / indirekt	2x 110°	100-02190110
	SYS 12W	380	80	3000	207 x 60 x 110	silber	direkt / indirekt	2x 110°	100-02190740



### NEXT W

INFORMATION	LEISTUNG	LUMEN	CRI>	KELVIN	B x H x T	FARBE	ART.NR.
Wandleuchte, Aluminium, Feinstruktur matt pulverbeschichtet, schwenkbare Doppelreflektoren für individuelle Lichtbildgestaltung, direkt/indirekt strahlend, inkl. Konverter	SYS 7W	2x 105	90	3000	100 x 100 x 100	weiß	472-291008w
	SYS 7W	2x 105	90	3000	100 x 100 x 100	grau	472-291008s
	SYS 7W	2x 105	90	3000	100 x 100 x 100	schwarz / gold	472-291008bgng1
	SYS 7W	2x 105	90	3000	100 x 100 x 100	anthrazit	472-291008ag



### KATHA I W

INFORMATION	LEISTUNG	LUMEN	CRI>	KELVIN	B x H x T	FARBE	ART.NR.
Wandleuchte, Aluminium, Feinstruktur matt pulverbeschichtet, schwenkbare Doppelreflektoren für individuelle Lichtbildgestaltung, direkt/indirekt strahlend, inkl. Konverter	SYS 7W	2x 105	90	3000	80 x 68 x 123	weiß	472-645a11w
	SYS 7W	2x 105	90	3000	80 x 68 x 123	grau	472-645a11s



### BEN SQUARE W

INFORMATION	LEISTUNG	LUMEN	CRI>	KELVIN	B x H x T	FARBE	ART.NR.
Wandleuchte, Aluminium, weiß matt, Feinstruktur pulverbeschichtet, rechteckig, direkt/indirekt strahlend, inkl. Konverter	SYS 9W	360	90	3000	80 x 200 x 80	grau	472-0060890003004
	SYS 9W	525	90	3000	80 x 200 x 80	weiß	472-0060890003005
	SYS 9W	320	90	3000	80 x 200 x 80	anthrazit	472-0060890003011

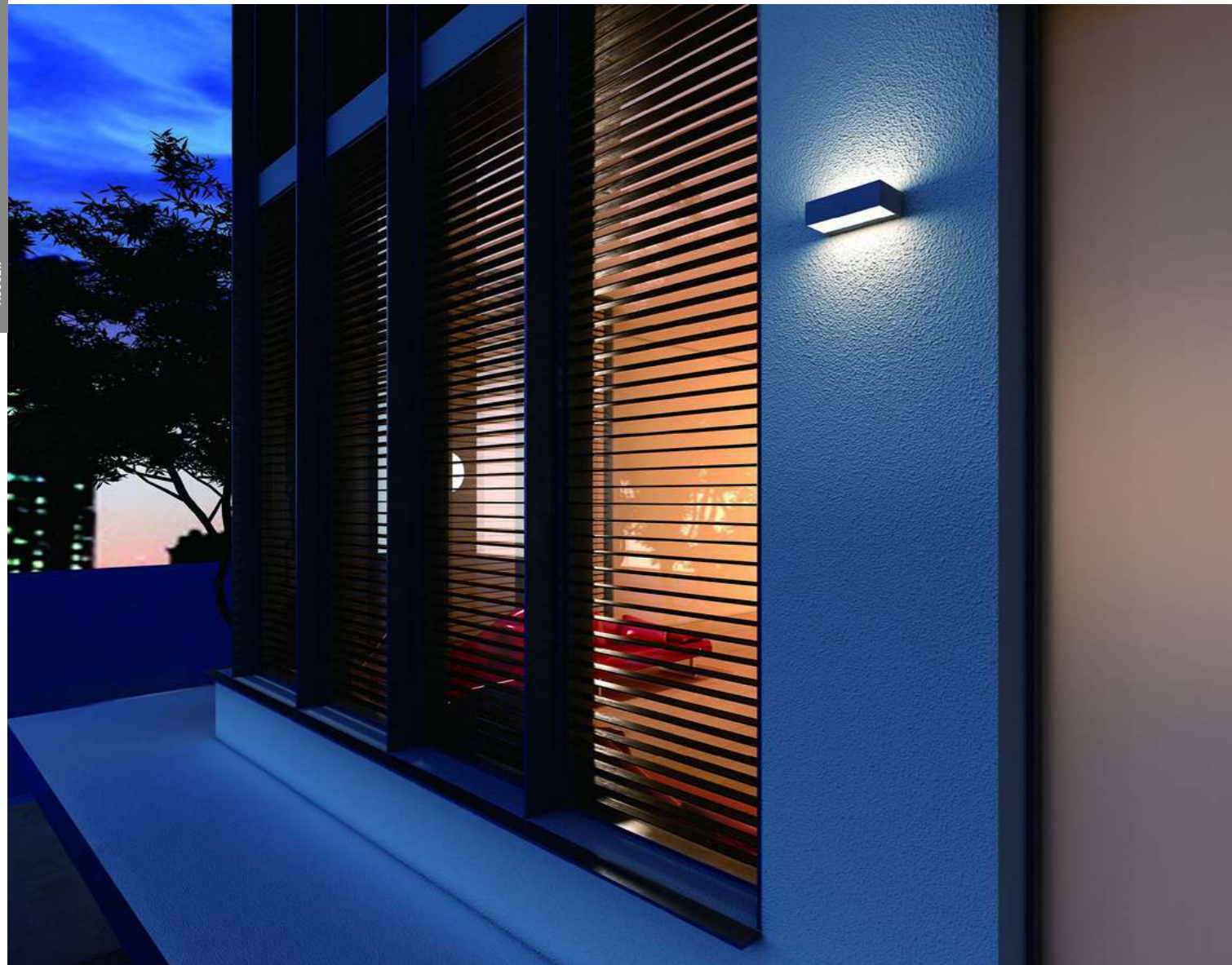

Projekt: Wohnhaus, Foto: PiL



Bildretusche, Foto: Shutterstock, Produkt: NEXT



**SKYE W**

**INFORMATION**

Wandleuchte, Aluminium, pulverbeschichtet, direkt/indirekt strahlend, schwenkbare Doppelreflektoren für individuelle Lichtbildgestaltung, inkl. Konverter



LEISTUNG	LUMEN	CRI>	KELVIN	B x H x T	FARBE	ART.NR.
SYS 16W	550	90	3000	150 x 150 x 150	weiß	472-260025
SYS 16W	480	90	3000	150 x 150 x 150	grau	472-260026



**ZAHRA W**

**INFORMATION**

Wandleuchte, Aluminiumdruckguss, pulverbeschichtet, direkt/indirekt strahlend, inkl. Konverter



LEISTUNG	LUMEN	CRI>	KELVIN	B x H x T	FARBE	ART.NR.
SYS 8W	2x 160	90	3000	100 x 100 x 45	weiß	472-260023
SYS 8W	2x 160	90	3000	100 x 100 x 45	grau	472-260024



**PIATTA W**

**INFORMATION**

Wandleuchte, Aluminiumdruckguss, pulverbeschichtet, direkt strahlend, Diffuser PMMA opal, inkl. Konverter



LEISTUNG	LUMEN	CRI>	KELVIN	B x H x T	FARBE	ART.NR.
SYS 7W	464	90	3000	170 x 75 x 45	weiß	472-643m21w
SYS 7W	308	90	3000	170 x 75 x 45	grau	472-643m21s



### EYO W

#### INFORMATION

Wandleuchte, Aluminiumdruckguss, pulverbeschichtet, direkt/indirekt strahlend, inkl. Konverter

LEISTUNG	LUMEN	CRI>	KELVIN	B x T x H	FARBE	ART.NR.
SYS 7W	200	90	3000	150 x 138 x 58	schwarz	472-90039600
SYS 7W	200	90	3000	150 x 138 x 58	anthrazit	472-90039900



### AVA W

#### INFORMATION

Wandleuchte, Aluminiumdruckguss, pulverbeschichtet, direkt/indirekt strahlend, inkl. Konverter

LEISTUNG	LUMEN	CRI>	KELVIN	B x H x T	FARBE	ART.NR.
SYS 11W	780	90	3000	187 x 100 x 60	weiß	472-0030990003005
SYS 11W	480	90	3000	187 x 100 x 60	grau	472-0030990003004



Produkt: FOCO W



### NELL W

#### INFORMATION

Wandleuchte, Aluminiumdruckguss, pulverbeschichtet, kugelförmig, Linse aus Glas, 80° Ausstrahlwinkel, direkt/indirekt strahlend, inkl. Konverter

LEISTUNG	LUMEN	CRI>	KELVIN	Ø x T	FARBE	ART.NR.
SYS 7W	325	90	3000	100 x 88	weiß	472-3729050
SYS 7W	275	90	3000	100 x 88	schwarz	472-3729060



### FOCO W

#### INFORMATION

Wandleuchte, Aluminiumdruckguss, pulverbeschichtet, klare Glaslinsen für parabolischen Lichteffect, direkt/indirekt strahlend, inkl. Konverter

LEISTUNG	LUMEN	CRI>	KELVIN	L x B x H	FARBE	LICHTAUSTRITT	REFL.	ART.NR.
SYS 9W	550	80	3000	121 x 107 x 65	anthrazit	direkt / indirekt	2x 100°	100-01190110
SYS 9W	550	80	3000	121 x 107 x 65	silber	direkt / indirekt	2x 100°	100-01190740





### PIGO W

#### INFORMATION

Wandleuchte, Aluminium gebürstet oder lackiert, direkt strahlend, inkl. Konverter

LEISTUNG	LUMEN	CRI>	KELVIN	Ø x H x T	FARBE	REFL.	ART.NR.
SYS 9W	535	80	3000	79 x 81 x 92	aluminium gebürstet	20°	472-256002
SYS 9W	535	80	3000	79 x 81 x 92	anthrazit	20°	472-256003



### BEN ROUND W

#### INFORMATION

Wandleuchte, Aluminiumdruckguss, pulverbeschichtet, direkt/indirekt strahlend, inkl. Konverter

LEISTUNG	LUMEN	CRI>	KELVIN	Ø x H x T	FARBE	ART.NR.
SYS 9W	2x 116	90	3000	90 x 250 x 95	weiß	472-0050890003005
SYS 9W	2x 116	90	3000	90 x 250 x 95	grau	472-0050890003004
SYS 9W	2x 116	90	3000	90 x 250 x 95	schwarz	472-0050890003011



Bildretusche, Foto: Shutterstock, Produkt: BEN ROUND W



### ZEON W

#### INFORMATION

Wandleuchte, Aluminiumdruckguss, pulverbeschichtet, opaler Diffusor und Klarglasabdeckung, indirekt strahlend, inkl. Konverter

LEISTUNG	LUMEN	CRI>	KELVIN	Ø x T	FARBE	ART.NR.
SYS 10W	320	90	3000	120 x 90	schwarz	472-0561090003006
SYS 10W	320	90	3000	120 x 90	anthrazit	472-0561090003011



### FYNN C W

#### INFORMATION

Wandleuchte, Aluminiumdruckguss, pulverbeschichtet, Diffusor aus opalem Acryl, AC-LED

LEISTUNG	LUMEN	CRI>	KELVIN	B x H x T	FARBE	ART.NR.
SYS 10W	642	90	3000	100 x 100 x 120	grau	472-260055s
SYS 10W	642	90	3000	100 x 100 x 120	anthrazit	472-260055ag





**SOPO SQUARE M**

**SOPO SQUARE L**

INFORMATION	LEISTUNG	LUMEN	CRI>	KELVIN	L x B x T	FARBE	ART.NR.
Wand- / Deckenleuchte, Aluminiumdruckguss, quadratisch, opaler Diffusor aus Polycarbonat, doppelte Kabelauslass, inkl. Konverter	SYS 25W	2685	80	3000	240 x 240 x 45	anthrazit	100-q24190110
	SYS 25W	2685	80	3000	240 x 240 x 45	silber	100-q24190740
	SYS 30W	2660	80	3000	300 x 300 x 49	anthrazit	100-q30190110
	SYS 30W	2660	80	3000	300 x 300 x 49	silber	100-q30190740



**SOPO ROUND M**

**SOPO ROUND L**

INFORMATION	LEISTUNG	LUMEN	CRI>	KELVIN	Ø x T	FARBE	ART.NR.
Wand- / Deckenleuchte, Aluminiumdruckguss, opaler Diffusor aus Polycarbonat, doppelter Kabelauslass, inkl. Konverter	SYS 25W	2570	80	3000	240 x 45	anthrazit	100-r24190110
	SYS 25W	2570	80	3000	240 x 45	silber	100-r24190740
	SYS 30W	2860	80	3000	300 x 49	anthrazit	100-r30190110
	SYS 30W	2860	80	3000	300 x 49	silber	100-r30190740



Produkt: SOPO SQUARE



Produkt: AEON ROUND BIG

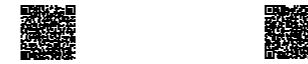

**AEON ROUND SMALL IP / AEON ROUND BIG IP**

INFORMATION	LEISTUNG	LUMEN	CRI>	KELVIN	Ø x H	FARBE	REFL.	ART.NR.
Runde LED Aufbauleuchte aus Aluminium, matt Feinstruktur pulverbeschichtet, inkl. Konverter;	SYS 11W	1070	80	3000	80 x 105	weiß	45°	305-652530w
	SYS 11W	1070	80	3000	80 x 105	schwarz	45°	305-652530b
AEON BIG: DALI dimmbar	SYS 20W	2055	80	3000	125 x 135	weiß	45°	305-654530wd
	SYS 20W	2055	80	3000	125 x 135	schwarz	45°	305-654530bd

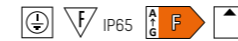

**TURN 2 SD GU10**

INFORMATION	LM	FASSUNG	V AC	W	B x H x T	FARBE	ART.NR.
Aufbaustrahler, Aluminium geätzt, 90° schwenkbar	RETROFIT	GU10	230	max. 7	88 x 90 x 115	aluminium gebürstet	472-256012
	RETROFIT	GU10	230	max. 7	88 x 90 x 115	anthrazit	472-256011



**FYNN 0 SD**

INFORMATION	LEISTUNG	LUMEN	CRI>	KELVIN	B x H x T	FARBE	ART.NR.
Aufbauleuchte, AC-LED, Aluminiumdruckguss, weiß matt, grau oder anthrazit grau pulverbeschichtet, Diffusor aus opalem Acryl	SYS 10W	790	90	3000	100 x 100 x 112	weiß	472-260056w
	SYS 10W	790	90	3000	100 x 100 x 112	grau	472-260056s
	SYS 10W	790	90	3000	100 x 100 x 112	anthrazit	472-260056ag



# Aussenleuchten Aufbau aus dem Molto Luce Programm

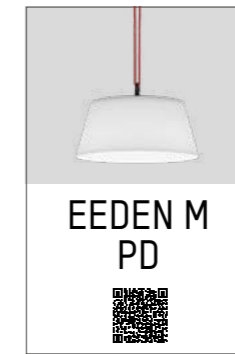



# STEHLEUCHTEN AUSSEN





### GLOBO OUT E27

INFORMATION	LM	FASSUNG	V AC	W	Ø	FARBE	REFL.	ART.NR.
Kugelleuchte aus Polyethylen, weiß, UV-beständig, hohe Zugfestigkeit, inkl. 2m Anschlusskabel schwarz, Erdspeiß und Schraubsockel, Montage auf Beton- sowie Erdböden möglich	RETROFIT	E27	230	max. 9	300	weiß opal	---	292-1a30w
	RETROFIT	E27	230	max. 11	400	weiß opal	---	292-1a40w
	RETROFIT	E27	230	max. 11	500	weiß opal	---	292-1a50w
	RETROFIT	E27	230	max. 11	600	weiß opal	---	292-1a60w

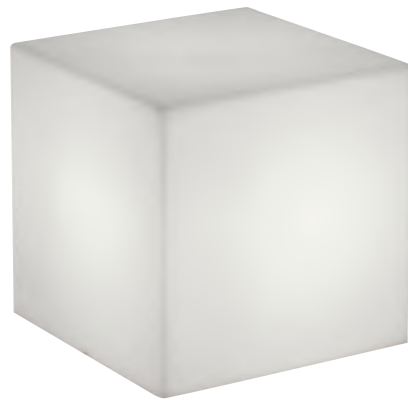

### CUBO OUT E27

INFORMATION	LM	FASSUNG	V AC	W	L x B x H	FARBE	REFL.	ART.NR.
Würfelleuchte aus Polyethylen, weiß, UV-beständig, hohe Zugfestigkeit, inkl. 2m Anschlusskabel schwarz, Erdspeiß und Schraubsockel, Montage auf Beton- sowie Erdböden möglich	RETROFIT	E27	230	max. 9	300 x 300 x 300	weiß opal	---	292-1lpcue030
	RETROFIT	E27	230	max. 11	430 x 430 x 430	weiß opal	---	292-1lpcue040

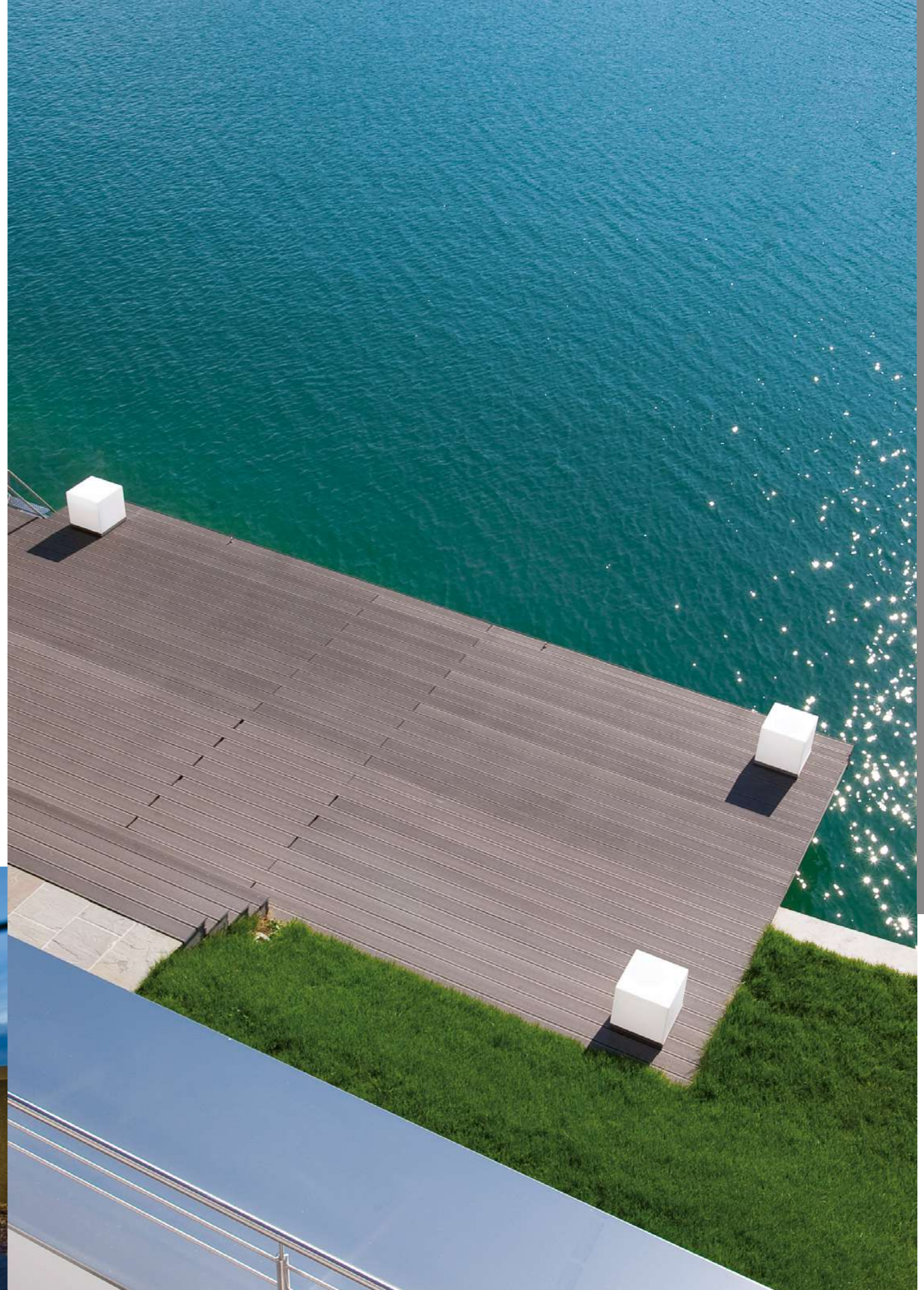

Projekt: Molto Luce, Wels, Österreich, Foto: Molto Luce, Produkt: GLOBO OUT



### FYNN CP F

#### INFORMATION

Pollerleuchte, AC-LED, Aluminium  
Feinstruktur pulverbeschichtet, Diffu-  
sor aus opalem Acryl, inkl. Konverter

LEISTUNG	V AC	LUMEN	CRI>	KELVIN	B x T x H	FARBE	ART.NR.
SYS 10W	230	642	90	3000	100 x 100 x 900	grau	472-260057s
SYS 10W	230	642	90	3000	100 x 100 x 900	anthrazit	472-260057ag



### ZEON F

#### INFORMATION

Pollerleuchte, Aluminiumdruckguss,  
Feinstruktur matt pulverbeschich-  
tet, opaler Diffusor und Klarglas-  
abdeckung, indirekt strahlend, inkl.  
Konverter

LEISTUNG	V AC	LUMEN	CRI>	KELVIN	Ø x H	FARBE	ART.NR.
SYS 13W	230	390	90	3000	120 x 900	schwarz	472-0571390003006
SYS 13W	230	390	90	3000	120 x 900	anthrazit	472-0571390003011

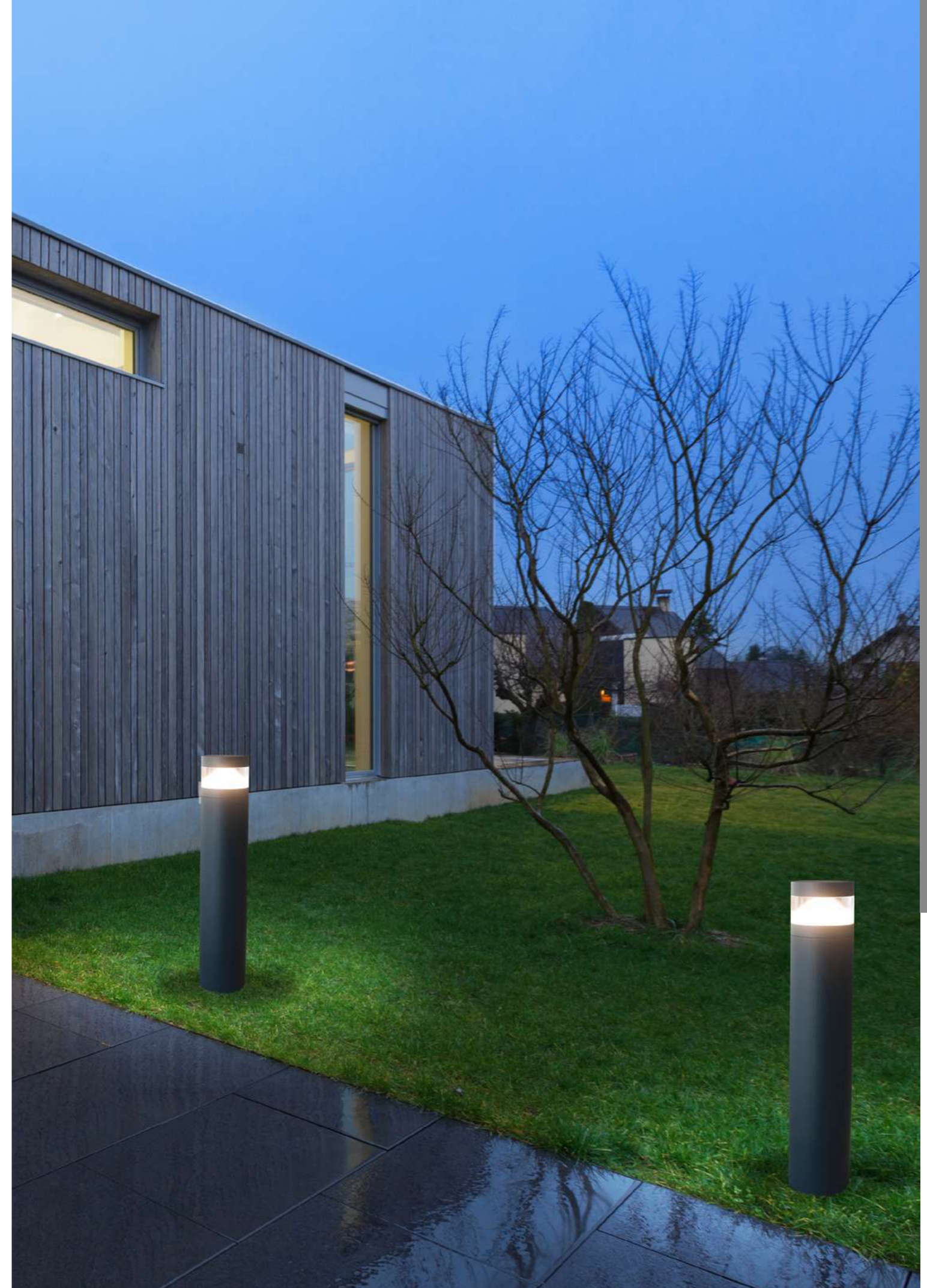



**YARA ROUND F**

**INFORMATION**

Pollerleuchte, Aluminiumdruckguss, Feinstruktur matt pulverbeschichtet, PC-Diffusor klar, 360° Ausstrahlwinkel, inkl. Konverter



LEISTUNG	V AC	LUMEN	CRI>	KELVIN	Ø x H	FARBE	ART.NR.
SYS 10W	230	685	80	3000	165 x 800	grau	273-1000s

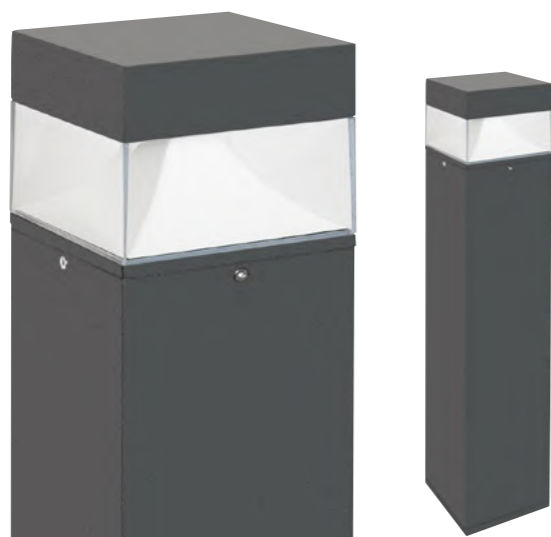

**YARA SQUARE F**

**INFORMATION**

Pollerleuchte, Aluminiumdruckguss, Feinstruktur matt pulverbeschichtet, PC-Diffusor klar, 360° Ausstrahlwinkel, inkl. Konverter



LEISTUNG	V AC	LUMEN	CRI>	KELVIN	L x B x H	FARBE	ART.NR.
SYS 10W	230	800	80	3000	150 x 150 x 800	grau	273-1002s



**FARO MIT LAMELLENRASTER E27**



**INFORMATION**

Pollerleuchte, extrudiertem Aluminium, Dreiphasen Pulverbeschichtung, grau oder silber, zylindrische Form, Abdeckung transparent aus Polycarbonat, bruchfest und V2-selbstlöschend, UV-stabilisiert, Lamellenraster aus 99.85-Aluminium, oxydiert, Sockel: DM=250mm



LM	FASSUNG	V AC	W	Ø x H	FARBE	REFL.	ART.NR.
RETROFIT	E27	230	max. 9	180 x 1040	grau	---	125-51000300
RETROFIT	E27	230	max. 9	180 x 1040	silber	---	125-51000400

**UNIVERSAL EINGRABESTÜCK INFORMATION**

Aluminiumrohr mit Verdrehenschutz und 3 Befestigungsschrauben, passend für Faro Pollerleuchten.

Montagehinweis:  
Die Bodenplatte muß waagrecht liegen und mit der Unterkante mit der Erdoberfläche abschließen (Abb. rechts)

**ABBILDUNG**

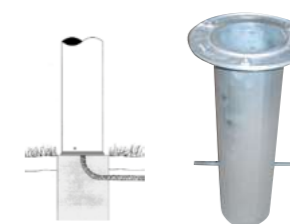

Ø x H	ART.NR.
180 x 400	88-981072



Foto: Disano, Produkt: FARO

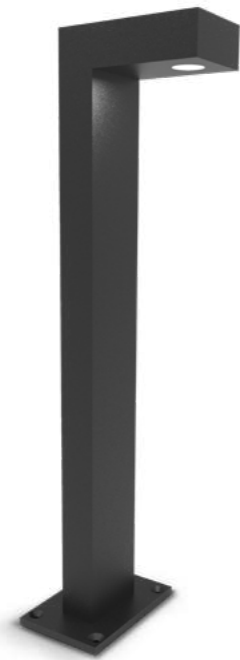

### ALIAR F

INFORMATION	LEISTUNG	LUMEN	CRI>	KELVIN	B x T x H	FARBE	ART.NR.
Pollerleuchte, Aluminiumdruckguss, Feinstruktur matt pulverbeschichtet, inkl. Konverter	SYS 12W	460	90	3000	80 x 150 x 600	schwarz	472-90029600
	SYS 12W	460	90	3000	80 x 150 x 600	anthrazit	472-90029900



### PG KLEMMROHR

#### INFORMATION



Klemmrohr mit PG Verschraubung für Wasserdichte Kabelverbindungen, 3-poliger Block, Verwendung nur mit Kabel H05SS-F, für Kabel Ø 7-12 mm für max. 24A / 450V AC, IP68

L x Ø	FARBE	ART.NR.
66 x 23	schwarz	102-thb391a3c



### BOOPER F

INFORMATION	LEISTUNG	LUMEN	CRI>	KELVIN	Ø x H	FARBE	ART.NR.
Pollerleuchte, Aluminiumdruckguss, Feinstruktur matt pulverbeschichtet, inkl. Konverter	SYS 9W	190	90	3000	80 x 600	weiß	472-90079500
	SYS 9W	190	90	3000	80 x 600	anthrazit	472-90079900



Foto: Shutterstock, Produkt: BOOPER F



### GLOBI KUGEL MIT SOCKEL FÜR MAST E27

INFORMATION	LM	FASSUNG	V AC	W	Ø x H	FARBE	ART.NR.
Mastaufsatzleuchte, Kugel aus bruchfestem und selbstlöschendem opalem PC, Grundplatte aus schwarzem Polyamid, Zopf 60mm, Mast separat ordern	RETROFIT	E27	230	max. 9	260 x 290	weiß opal / schwarz	125-42670100
	RETROFIT	E27	230	max. 9	320 x 355	weiß opal/ schwarz	125-42670500

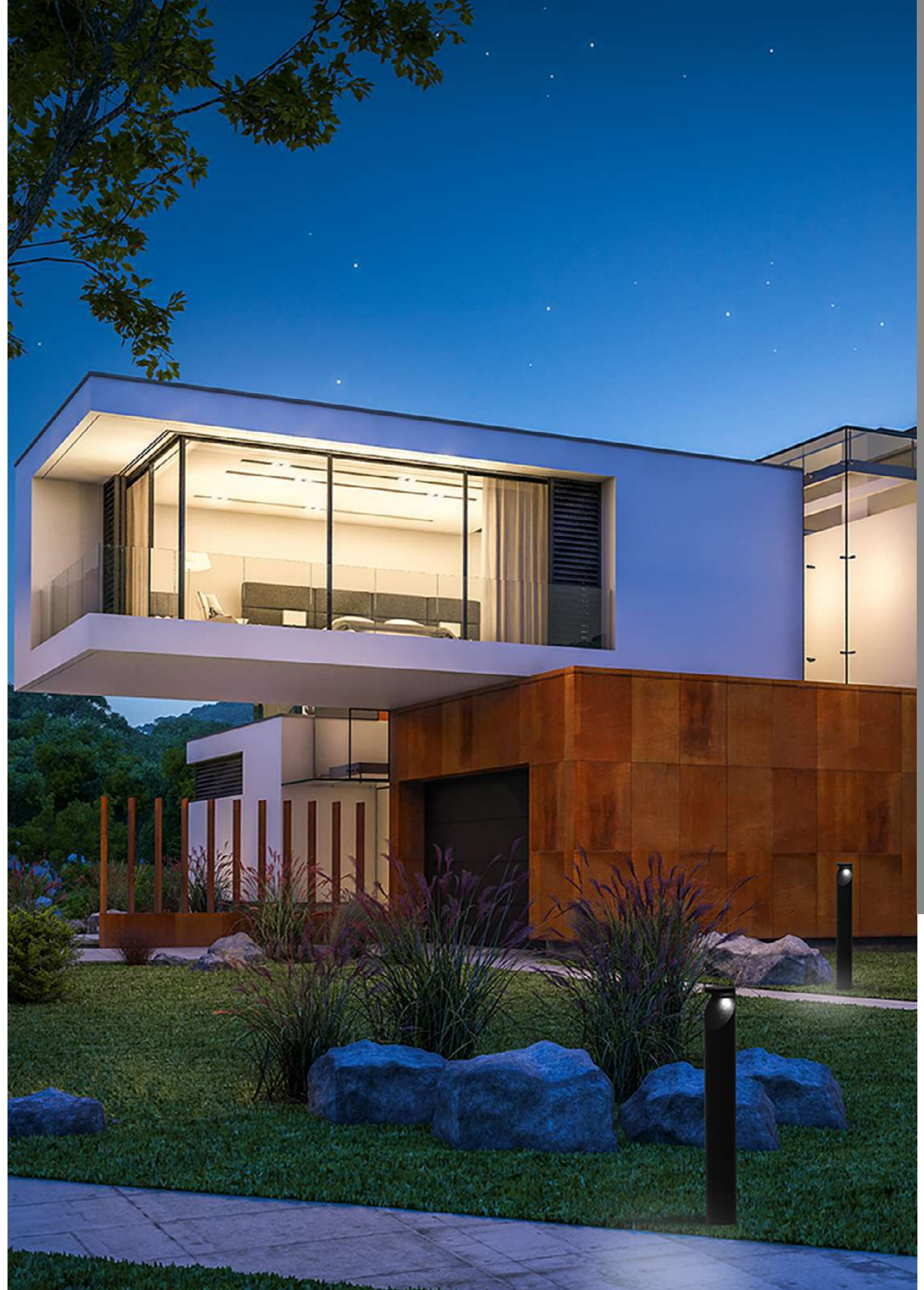

### GLOBO LED KUGEL MIT SOCKEL FÜR MAST

INFORMATION	LEISTUNG	LUMEN	CRI>	KELVIN	Ø x H	FARBE	ART.NR.
Mastleuchte, Kugel aus bruchfestem V2-Polycarbonat, obere Teile verspiegelt, Basis aus Aluminiumdruckguss, pulverbeschichtet, Zopf 60/76mm, inkl. Konverter, Mast separat ordern	SYS 29W	1309	80	4000	400 x 520	silber	125-42560000



### GLOBI KUGEL OHNE SOCKEL FÜR MAST

INFORMATION	Ø x H	FARBE	ART.NR.
Kugel aus bruchfestem und V2-selbstlöschendem opalem Polycarbonat, Fassungssockel und Mast separat ordern	400 x 388	weiß opal	125-42562100
	450 x 436	weiß opal	125-42561300



### MASTSOCKEL FÜR GLOBI KUGEL E27

INFORMATION	LM	FASSUNG	V AC	W	FÜR KUGEL Ø	FARBE	ART.NR.
Fassungssockel für Mast, Aluminium, pulverbeschichtet, Zopf: Ø=60mm, für Kugel mit Ø 400/450mm, Mast separat ordern	RETROFIT	E27	230	max. 9	400 / 450	graphit	125-42625900

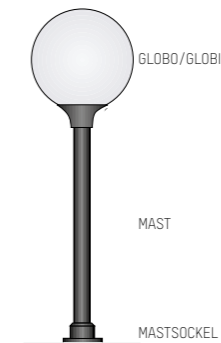

### MAST FÜR GLOBO / GLOBI

INFORMATION	Ø x H	FARBE	ART.NR.
Mast für GLOBO/GLOBI, ohne Inspektionsfenster aus glasfaserverstärktem Nylon, schwarz, korrosionstfest, UV stabilisiert, gerade, Vorteile vom Polyester-masten: leichter, geringe Wartung, keine Korrosionsschäden, elektrisch isolierend, hohe Stoßfestigkeit, Kugel und Mastsockel separat ordern, Zopf Ø 60mm	60 x 1000	schwarz	125-99190300
	60 x 1500	schwarz	125-99190400
	60 x 2000	schwarz	125-99190500



### MASTSOCKEL

INFORMATION	Ø x H	FARBE	ART.NR.
für Mast Ø 60, inkl. Dübel zum Vergraben, max. Masthöhe 2000mm	190 x 115	schwarz	125-99121600



### SUSA

INFORMATION	LEISTUNG	LUMEN	CRI>	KELVIN	B x H x T	FARBE	ART.NR.
Mastleuchte aus Aluminiumdruckguss, grau pulverbeschichtet, PMMA-Optik, spezielle Linsenoptik gegen Lichtverschmutzung, geeignet für Mastzopf DM 45/60mm, inkl. Konverter, nicht dimmbar	SYS 26W	3600	80	4000	156 x 80 x 540	grau	125-34050400
	SYS 40W	5145	80	4000	156 x 80 x 540	grau	125-34050000
	SYS 81W	9979	80	4000	156 x 80 x 540	grau	125-34050100
	SYS 107W	12360	80	4000	156 x 80 x 540	grau	125-34050300

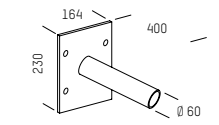

WANDAUSLEGER	INFORMATION	L	ART.NR.
	Wandausleger mit Zopf DM 60mm, Stahl, starr, verzinkt, für Susa	400	125-99770800

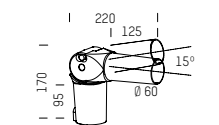
MASTAUFSAATZKONSOLE	INFORMATION	Ø x L x H	FARBE	ART.NR.
	Mastaufsatz für Zopf DM 60mm, Stahl, 90° schwenkbar, für Susa	60 x 220 x 170	grau	125-99138500

MASTAUFSAATZKONSOLE	INFORMATION	Ø x L x H	ART.NR.
	Mastaufsatz für Zopf DM 60mm, Stahl, 90° starr, verzinkt für Susa	60 x 195 x 205	125-42694100
		60 x 535 x 270	125-42694800



Foto: Disano, Produkt: SUSA

# Weitere Tisch- / Stehleuchten aus dem Molto Luce Programm



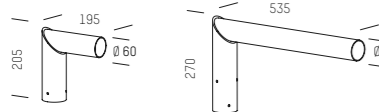
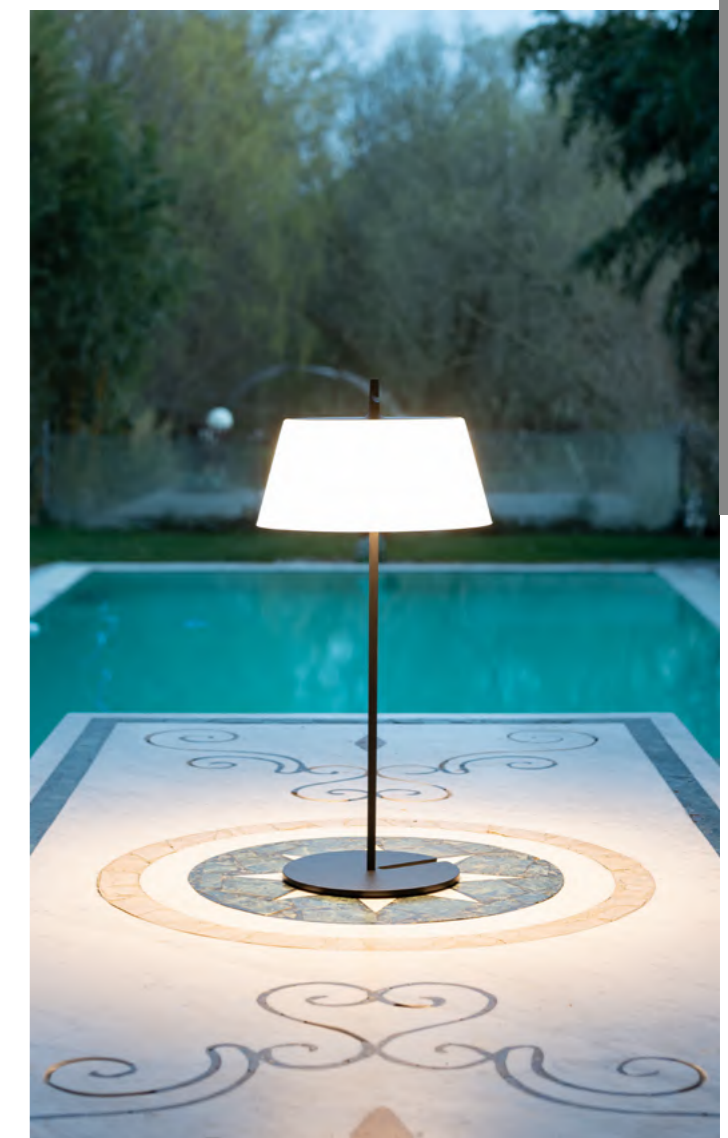
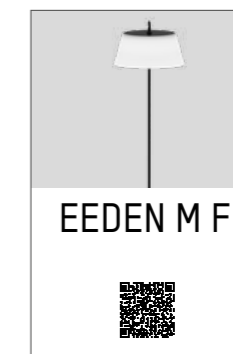
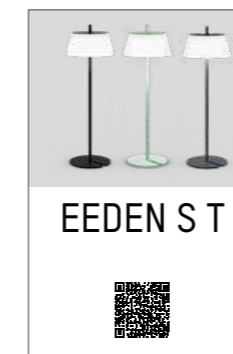

# FLUTER+ STRAHLER

MOLTO LUCE®



grau



anthrazit

### MICRO RODIO SYMMETRISCH

INFORMATION	LEISTUNG	V AC	LUMEN	CRI>	KELVIN	B x H x T	FARBE	ART.NR.
Fluter aus Aluminiumdruckguss, pulverbeschichtet mit symmetrischer COB-Optik, 90° schwenkbar, gehärtetes Schutzglas - Dicke 4mm, inkl. Konverter	SYS 29W	230	2309	90	3000	145 x 227 x 45	grau	125-41486039
	SYS 29W	230	2309	90	3000	145 x 227 x 45	anthrazit	125-41486239
	SYS 29W	230	2483	90	4000	145 x 227 x 45	grau	125-41486000
	SYS 29W	230	2483	90	4000	145 x 227 x 45	anthrazit	125-41486200
	SYS 38W	230	2811	90	3000	145 x 227 x 45	grau	125-41486539
	SYS 38W	230	2811	90	3000	145 x 227 x 45	anthrazit	125-41486739
	SYS 38W	230	3023	90	4000	145 x 227 x 45	grau	125-41486500
	SYS 38W	230	3023	90	4000	145 x 227 x 45	anthrazit	125-41486700



WANDAUSLEGER	INFORMATION	L	FARBE	ART.NR.
	Wandausleger, Stahl, schwenkbar, für Micro Rodio	800	grau	125-99550600
		800	anthrazit	125-99550900

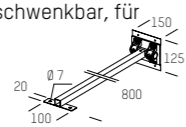

### MICRO RODIO L SYMMETRISCH MICRO RODIO L ASYMMETRISCH

INFORMATION	SYMMETRISCH							
	LEISTUNG	V AC	LUMEN	CRI>	KELVIN	B x H x T	FARBE	ART.NR.
Fluter aus Aluminiumdruckguss, pulverbeschichtet mit asymmetrischer oder symmetrischer COB-Optik, 90° schwenkbar, gehärtetes Schutzglas - Dicke 4mm, inkl. Konverter	SYS 28W	230	3056	80	4000	145 x 227 x 45	grau	125-41489000
	<b>ASYMMETRISCH</b>							
	SYS 28W	230	3118	80	4000	145 x 227 x 45	grau	125-41487000



WANDAUSLEGER	INFORMATION	L	FARBE	ART.NR.
	Wandausleger, Stahl, schwenkbar, für Micro Rodio	800	grau	125-99550600
		800	anthrazit	125-99550900

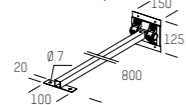

### MINI RODIO SYMMETRISCH MINI RODIO ASYMMETRISCH



INFORMATION	SYMMETRISCH							
	LEISTUNG	V AC	LUMEN	CRI>	KELVIN	B x H x T	FARBE	ART.NR.
Fluter aus Aluminiumdruckguss, pulverbeschichtet mit asymmetrischer oder symmetrischer Linsen-Optik, 90° schwenkbar, gehärtetes Schutzglas - Dicke 4mm, inkl. Konverter	SYS 54W	230	8292	80	4000	273 x 400 x 70	grau	125-41494000
	SYS 73W	230	10194	80	4000	273 x 400 x 70	grau	125-41494100
	<b>ASYMMETRISCH</b>							
	SYS 54W	230	8456	80	4000	273 x 400 x 70	grau	125-41491000
	SYS 73W	230	10396	80	4000	273 x 400 x 70	grau	125-41491100



PG KLEMMROHR	INFORMATION	L x Ø	FARBE	ART.NR.
	Klemmrohr mit PG Verschraubung für Wasserdichte Kabelverbindungen, 3-poliger Block, Verwendung nur mit Kabel H05SS-F, für Kabel Ø 7-12 mm für max. 24A / 450V AC, IP68	66 x 23	schwarz	102-thb391a3c

PG KLEMMROHR Y-FORM	INFORMATION	L x B x Ø	FARBE	ART.NR.
	Klemmrohr mit PG Verschraubung für Wasserdichte Kabelverbindungen, 3-poliger Block, Verwendung nur mit Kabel H05SS-F, für Kabel Ø 7-13,5 mm für max. 24A / 450V AC, IP68	180 x 66 x 34	schwarz	102-thb399a3c



disano illuminazione



**RODIO SYMMETRISCH LED    RODIO ASYMMETRISCH LED**

INFORMATION	SYMMETRISCH							
	LEISTUNG	V AC	LUMEN	CRI>	KELVIN	B x H x T	FARBE	ART.NR.
Fluter aus Aluminiumdruckguss, pulverbeschichtet mit asymmetrischer oder symmetrischer Linsenoptik, 90° schwenkbar, gehärtetes Schutzglas, inkl. Konverter	SYS 53W	230	8627	80	4000	333 x 568 x 85	grau	125-41478400
	SYS 79W	230	11561	80	4000	333 x 568 x 85	grau	125-41478500
	SYS 118W	230	16881	80	4000	333 x 568 x 85	grau	125-41478600
	SYS 157W	230	21140	80	4000	333 x 568 x 85	grau	125-41478700
	ASYMMETRISCH							
	SYS 53W	230	8799	80	4000	333 x 568 x 85	grau	125-41475400
	SYS 79W	230	11789	80	4000	333 x 568 x 85	grau	125-41475500
	SYS 118W	230	17213	80	4000	333 x 568 x 85	grau	125-41475600
	SYS 157W	230	21559	80	4000	333 x 568 x 85	grau	125-41475700

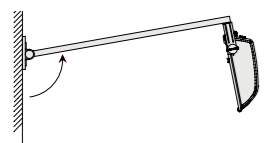

WANDAUSLEGER	INFORMATION	L	FARBE	ART.NR.
	Wandausleger, Stahl, schwenkbar, für Rodio	975	grau	125-99550400

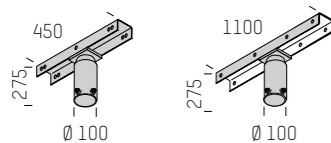
MASTAUFSAZKONSOLE	INFORMATION	FÜR	Ø x L x H	ART.NR.
	Mastaufsatzkonsole, verzinkt, für Mastzopf 60/76mm, Befestigung von 1-2 oder 2-4 Strahlern möglich, für Rodio, Fluter separat ordern	1 oder 2 FLUTER	100 x 450 x 275	125-99790000
		2 oder 4 FLUTER	100 x 1100 x 275	125-99790100

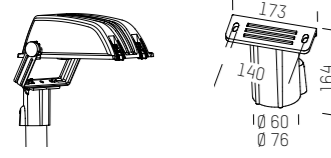
MASTAUFSAZKONSOLE	INFORMATION	FÜR	Ø x L x H	FARBE	ART.NR.
	Mastaufsatzkonsole, Aluminium, für Mastzopf DM= 60mm oder 76mm, für Lito, Indio und Rodio, Fluter separat ordern	1 FLUTER f. Mastzopf Ø 60	60 x 173 x 164	grau	125-99791500
		1 FLUTER f. Mastzopf Ø 76	76 x 173 x 164	grau	125-99791600

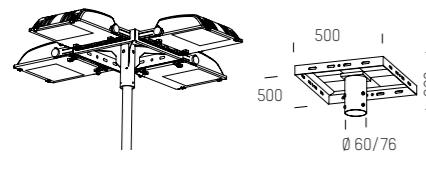
MASTAUFSAZKONSOLE	INFORMATION	FÜR	L x B x H	ART.NR.
	Mastaufsatzkonsole, verzinkt, für Mastzopf 60/76mm, Befestigung von 1-4 Strahlern möglich, für Rodio, Fluter separat ordern	1 - 4 Fluter für Mastzopf Ø 60/76	500 x 500 x 280	125-99809700



Projekt: Andels Hotel, Lodz, Polen, Foto: Molto Luce, Produkt: RODIO



### FORIS

INFORMATION	LEISTUNG	V AC	LUMEN	CRI>	KELVIN	Ø x H	FARBE	REFL.	ART.NR.
Strahler, Aluminiumdruckguss, pulverbeschichtet, AC LED, Leuchtenkopf 330° drehbar und 90° schwenkbar, inkl. Erdspeiß	SYS 10W	230	740	80	3000	100 x 140	anthrazit	50°	341-0011080503011
	<b>ENTBLENDUNGSRING FORIS</b>		<b>LM BEI MONTAGE</b>		<b>Ø x H</b>	<b>FARBE</b>	<b>ART.NR.</b>		
	Entblendungsring mit Schraubverschluss, Aluminiumdruckguss pulverbeschichtet		525		102 x 100	anthrazit	341-7000		



### HARK

INFORMATION	LEISTUNG	V AC	LUMEN	CRI>	KELVIN	Ø x B x H	FARBE	REFL.	ART.NR.
Aufbaustrahler, AC-LED, Aluminiumdruckguss, pulverbeschichtet, 350° dreh- und 90° schwenkbar, inkl. Erdspeiß, inkl. Kabel (Länge = 1320mm)	SYS 4W	230	255	80	3000	54 x 80 x 96	anthrazit	40°	472-0250480403011



### CHOPA F

INFORMATION	LEISTUNG	V AC	LUMEN	CRI>	KELVIN	Ø x B x H	FARBE	REF	ART.NR.
Erdspeissleuchte, Aluminiumdruckguss, pulverbeschichtet, 180° schwenkbar, 350° drehbar, höhenverstellbar, inkl. Konverter und 1300mm Kabel mit Stecker	SYS 7W	230	450	90	3000	60 x 132 x 400	schwarz	38°	472-90059600

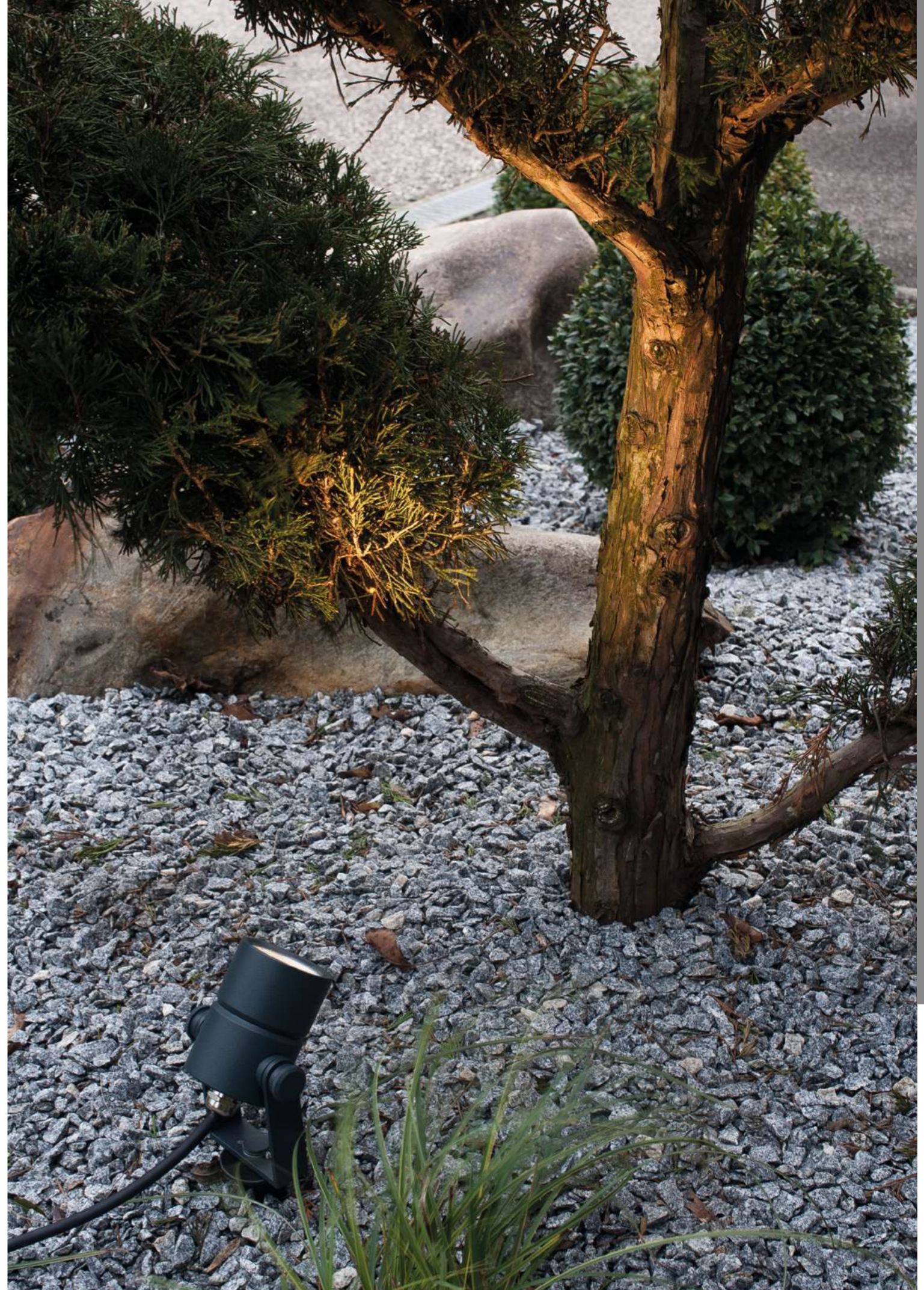

Projekt: Wohnhaus, Österreich, Foto: Molto Luce, Produkt: HARK



silber

grau

**KOALA**

INFORMATION	LEISTUNG	V AC	LUMEN	CRI>	KELVIN	Ø x H	Ø x H SOCKEL	FARBE	REFL.	ART.NR.
Aufbaustrahler, Aluminiumdruckguss, pulverbeschichtet, 90° schwenkbar, Sockel aus bruchfestem Polyamid, gehärtetes Siebdruckglas, inkl. Konverter	SYS 15W	230	1195	90	3000	114 x 194	127 x 62	silber	46°	125-43182800
	SYS 15W	230	1195	90	3000	114 x 194	127 x 62	grau	46°	125-43182900

ENTBLENDUNGSRING INFORMATION	ABBILDUNG	Ø x T	FARBE	ART.NR.
Entblendungsring schräg für KOALA		119 x 98	grau	125-99133000

ERDSPIESS INFORMATION	ABBILDUNG	L x B x H	FARBE	ART.NR.
Erdspieß für KOALA		74 x 30 x 175	schwarz	125-99133500

**KOALA HV**

INFORMATION	LM	FASSUNG	V AC	W	Ø x H	Ø x H SOCKEL	FARBE	REFL.	ART.NR.
Aufbaustrahler, Aluminiumdruckguss, pulverbeschichtet, 90° schwenkbar, Sockel aus bruchfestem Polyamid, gehärtetes Siebdruckglas	RETROFIT	GU10	230	max. 7	114 x 194	127 x 62	silber	46°	125-43181500

ENTBLENDUNGSRING INFORMATION	ABBILDUNG	Ø x T	FARBE	ART.NR.
Entblendungsring schräg für KOALA		119 x 98	silber	125-99133000

ERDSPIESS INFORMATION	ABBILDUNG	L x B x H	FARBE	ART.NR.
Erdspieß für KOALA		74 x 30 x 175	schwarz	125-99133500





### JIB W

#### INFORMATION

Auslegerleuchte, Aluminiumdruckguss, matt pulverbeschichtet, AC LED, Leuchtenkopf 90° schwenkbar, 320° drehbar, Montagehinweis: nur direkt strahlend!

LEISTUNG	V AC	LUMEN	CRI>	KELVIN	L x B x H	FARBE	REFL.	ART.NR.
SYS 8W	230	475	80	3000	650 x 95 x 236	silber matt	50°	341-0000880503004
SYS 8W	230	475	80	3000	650 x 95 x 236	anthrazit	50°	341-0000880503011



### VIDERI LONG W

#### INFORMATION

Auslegerleuchte, Aluminiumdruckguss, matt pulverbeschichtet, AC LED, Leuchtenkopf 90° schwenkbar, 340° drehbar, Montagehinweis: nur direkt strahlend!

LEISTUNG	V AC	LUMEN	CRI>	KELVIN	L x B x H	FARBE	REFL.	ART.NR.
SYS 15W	230	910	80	3000	680 x 130 x 95	silber matt	120°	341-0021580003004
SYS 15W	230	910	80	3000	680 x 130 x 95	anthrazit	120°	341-0021580003011



### VIDERI SHORT W

#### INFORMATION

Wandleuchte, Aluminiumdruckguss, matt pulverbeschichtet, AC LED, Leuchtenkopf 90° schwenkbar, 340° drehbar, Montagehinweis: nur direkt strahlend!

LEISTUNG	V AC	LUMEN	CRI>	KELVIN	L x B x H	FARBE	REFL.	ART.NR.
SYS 15W	230	910	80	3000	200 x 130 x 95	silber matt	120°	341-0031580003004
SYS 15W	230	910	80	3000	200 x 130 x 95	anthrazit	120°	341-0031580003011

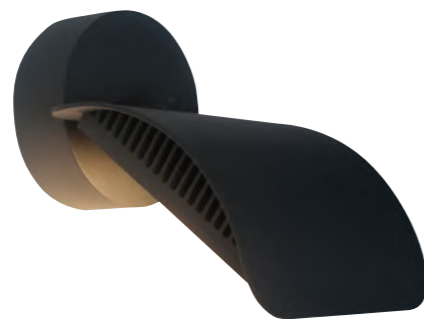



Bildretusche, Foto: Molto Luce, Produkt: JIB

## TRANSFORMATOREN





ELEKTRONISCHER TRANSFORMATOR	INFORMATION	W	L x B x H	FARBE	ART.NR.
	Elektronischer Transformator, weiß, dimmbar mit Phasen- / abschnittdimmer, thermisch progressive Sicherung (NTC), gesichert gegen Kurzschluß und Überlast auf Sekundärseite, automatische Wiederherstellung, elektromagnetische Verträglichkeit, Funkenstörfilter gem. EN55014/5, Transformatorbefestigung durch Ösen und Schrauben, Klemmabdeckung mit integrierter Zugentlastung, primär 2,5mm <sup>2</sup> , sekundär bis 2,5mm <sup>2</sup> (60-105VA), bzw. bis 6mm <sup>2</sup> (150VA), * nur Phasenabschnitt dimmbar (210 und 250VA)	10-60	94 x 31 x 20	weiß	24-119654
		20-105	128 x 38 x 28	weiß	24-119730
		30-150	166 x 47 x 35	weiß	24-119851u

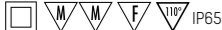

ELEKTRONISCHER TRANSFORMATOR	INFORMATION	W	L x B x H	FARBE	ART.NR.
	Elektronischer Transformator, schwarz, vergossen, dimmbar mit Phasenabschnittdimmer, thermisch progressive Sicherung gesichert gegen Kurzschluß und Überlast auf Sekundärseite, elektromagnetische Verträglichkeit, Funkenstörfilter gem. EN55014/5, Anschluß mit Litzekabel Länge 200mm, Primärleitung 2x 0,75mm <sup>2</sup> doppelt isoliert, Sekundärleitung 2x 0,75mm <sup>2</sup> , Umgebungstemperatur -10° bis +40°	20-60	104 x 30 x 21	schwarz	75-pr60
		20-105	134 x 30 x 21	schwarz	75-pr105



ELEKTRONISCHER TRANSFORMATOR	INFORMATION	W	Ø x H	FARBE	ART.NR.
	Elektronischer Transformator, weiß, rund, dimmbar mit Phasen- / abschnittdimmer, thermisch progressive Sicherung (NTC) gesichert gegen Kurzschluß und Überlast auf Sekundärseite, Wederherstellung automatisch, elektromagnetische Verträglichkeit, Funkenstörfilter gem. EN55014/5, Ausgangsspannung 12V	20-60	53 x 19	weiß	24-119640
		20-105	70 x 22	weiß	24-119618





## KONSTANTSTROM KONVERTER

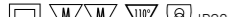

KONVERTER STM/U	INFORMATION	W	mA	V DC	L x B x H	FARBE	ART.NR.
	Konverter, nicht dimmbar, 230 V AC	6	250	23	42 x 40 x 22	schwarz	24-127719
		8	350	23	42 x 40 x 22	schwarz	24-127715
		6	500	9	42 x 40 x 22	schwarz	24-127717
		6	700	12	42 x 40 x 22	schwarz	24-127718



KONVERTER BULL/U	INFORMATION	W	mA	V DC	L x B x H	FARBE	ART.NR.
	Konverter, nicht dimmbar, 230 V AC	9	250	36	60 x 35 x 21,5	weiß	24-141133
		4	350	12	60 x 35 x 21,5	weiß	24-141130
		6	350	22	60 x 35 x 21,5	weiß	24-141132
		6	500	12	60 x 35 x 21,5	weiß	24-141131





## KONSTANTSTROM KONVERTER

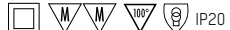

KONVERTER STC/U	INFORMATION	W	mA	V DC	L x B x H	FARBE	ART.NR.
	Konverter, nicht dimmbar, 230 V AC	8	350	23	51 x 31 x 21	schwarz	24-141050
		6	500	12	51 x 31 x 21	schwarz	24-141054





KONVERTER SLIM/U	INFORMATION	W	mA	V DC	L x B x H	FARBE	ART.NR.
	Konverter, nicht dimmbar, 230 V AC	15	350	43	142 x 22 x 19	weiß	24-141110



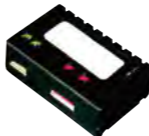

KONVERTER PMR	INFORMATION	W	mA	V DC	Ø x H	FARBE	ART.NR.
	Konverter, nicht dimmbar, 230 V AC	8,4	700	12	53 x 19	weiß	75-pmr12





KONVERTER PMR	INFORMATION	W	mA	V DC	L x B x H	FARBE	ART.NR.
	Konverter, nicht dimmbar, 230 V AC	1,5	350	6	51 x 32 x 18	schwarz	75-mp11
		4	350	12	51 x 32 x 18	schwarz	75-mp13
		2	700	6	51 x 32 x 18	schwarz	75-mp14
		4	500	9	51 x 32 x 18	schwarz	75-mp15



KONVERTER STPM/U IP54	INFORMATION	W	mA	V DC	L x B x H	FARBE	ART.NR.
	Konverter, nicht dimmbar, 230 V AC	8	350	23	44 x 46 x 26,5	schwarz	24-127703
		6	500	12	44 x 46 x 26,5	schwarz	24-127705
		6	700	12	44 x 46 x 26,5	schwarz	24-127701





KONVERTER SUPER PRO	INFORMATION	W	mA	V DC	L x B x H	FARBE	ART.NR.
	Konverter, nicht dimmbar, 230 V AC	16	350	46	147 x 44 x 30	weiß	24-127530n
		23	500	46	147 x 44 x 30	weiß	24-127532n
		32	700	45	147 x 44 x 30	weiß	24-127534n
		38	900	42	147 x 44 x 30	weiß	24-127536n
		42	1050	40	147 x 44 x 30	weiß	24-127538n





## KONSTANTSTROM KONVERTER

KONVERTER PRO FLAT 22	INFORMATION						W	mA	V DC	L x B x H	FARBE	ART.NR.
 Konverter, nicht dimmbar, 230 V AC Einstellbar mittels DIP-SWITCH:	mA	W	V DC	mA	W	V DC	5,5-22	125-500	44	147 x 44 x 22	weiß	24-127570
	125	5,5	44	325	14	44						
	150	6,5	44	350	15	44						
	175	7,5	44	375	16,5	44						
	200	8,5	44	400	17,5	44						
	225	9,5	44	425	18,5	44						
	250	11	44	450	19,5	44						
	275	12	44	475	21	44						
300	13	44	500	22	44							

KONVERTER UNIVERSALE 20	INFORMATION						W	mA	V DC	L x B x H	FARBE	ART.NR.
 Konverter, nicht dimmbar, 230 V AC Einstellbar mittels DIP-SWITCH: Konstantstrom	mA	W	V DC	mA	W	V DC	54-29	250-700	57-28	111 x 52 x 22	weiß	24-122201
	250	13	54	500	20	40						
	350	19	54	550	20	37						
	400	20	50	600	20	34						
	450	20	44	700	20	29						

KONVERTER PROFESSIONALE 34	INFORMATION						W	mA	V DC	L x B x H	FARBE	ART.NR.
 Konverter, nicht dimmbar, 230 V AC Einstellbar mittels DIP-SWITCH:	mA	W	V DC	mA	W	V DC	12-34	250-700	50-48	147 x 44 x 30	weiß	24-127480n
	250	12	50	500	25	50						
	300	15	50	550	27	50						
	350	17	50	600	30	50						
	400	20	50	650	32	49						
	450	22	50	700	34	48						

KONVERTER PROFESSIONALE 42	INFORMATION						W	mA	V DC	L x B x H	FARBE	ART.NR.
 Konverter, nicht dimmbar, 230 V AC Einstellbar mittels DIP-SWITCH:	mA	W	V DC	mA	W	V DC	13-42	300-1050	44-40	147 x 44 x 30	weiß	24-127484n
	300	13	44	700	31	44						
	350	15	44	750	32	44						
	400	18	44	800	33	42						
	450	20	44	850	35	42						
	500	22	44	900	38	42						
	550	24	44	950	40	42						
	600	27	44	1000	42	42						
	650	29	44	1050	42	40						

KONVERTER PROFESSIONALE IN 42	INFORMATION						W	mA	V DC	L x B x H	FARBE	ART.NR.
 Konverter, nicht dimmbar, 230V AC doppelter Anschlussblock für Durchgangsverdrahtung Einstellbar mittels DIP-SWITCH:	mA	W	V DC	mA	W	V DC	13-42	300-1050	44-40	132 x 79 x 30	grau	24-127693
	300	13	44	700	31	44						
	350	15	44	750	33	44						
	400	18	44	800	35	44						
	450	20	44	850	37	44						
	500	22	44	900	42	44						
	550	24	44	950	42	42						
	600	27	44	1000	42	42						
	650	29	44	1050	42	40						

## KONSTANTSTROM KONVERTER

KONVERTER PROFESSIONALE IN 52	INFORMATION						W	mA	V DC	L x B x H	FARBE	ART.NR.
 Konverter, nicht dimmbar, 230V AC doppelter Anschlussblock für Durchgangsverdrahtung Einstellbar mittels DIP-SWITCH:	mA	W	V DC	mA	W	V DC	27,3-52	650-1400	42-37,5	132 x 79 x 30	grau	24-127483
	650	27,3	42	1050	42	40						
	700	29,4	42	1100	42,9	39						
	750	30,7	41	1150	44,8	39						
	800	32,8	41	1200	46,8	39						
	850	34,8	41	1250	47,5	38						
	900	36	40	1300	49,4	38						
	950	38	40	1350	51,3	38						
	1000	40	40	1400	52	37,5						

KONVERTER MP 50 K3	INFORMATION						W	mA	V DC	L x B x H	FARBE	ART.NR.
 Konverter, nicht dimmbar, 230 V AC Einstellbar mittels DIP-SWITCH:	mA	W	V DC	mA	W	V DC	25-50	350-1050	74-48	124 x 79 x 22	weiß	24-122204
	350	25	74	750	50	66						
	500	35	72	850	50	58						
	550	39	72	900	50	55						
	650	46	72	1050	50	48						
	700	50	71									

## KONSTANTSTROM KONVERTER DIMMBAR

KONVERTER MINI JOLLY 20	INFORMATION						W	mA	V DC	L x B x H	FARBE	ART.NR.
 Konverter, 1-10V & PUSH dimmbar, 230V AC Einstellbar mittels DIP-SWITCH: Konstantstrom	mA	W	V DC	mA	W	V DC	13-20	250-900	53-23	111 x 52 x 22	weiß	24-151400
	250	13	53	600	20	34						
	300	15	52	650	20	31						
	350	18	50	700	20	29						
	400	20	50	750	20	27						
	450	20	45	800	20	25						
	500	20	40	850	20	24						
	550	20	37	900	20	23						



KONVERTER MINI JOLLY LC 20	INFORMATION						W	mA	V DC	L x B x H	FARBE	ART.NR.
 Konverter, 1-10V & Push dimmbar, 230V AC Einstellbar mittels DIP-SWITCH: Konstantstrom	mA	W	V DC	mA	W	V DC	5,4-20	100-380	54-52	111 x 52 x 22	weiß	24-151401
	100	5,4	54	260	14	53						
	120	6,4	54	280	15	53						
	140	7,5	53	300	16	52,5						
	160	8,5	53	320	17	52						
	180	9,5	53	340	18	52						
	200	10,6	53	360	19	52						
	220	12	53	380	20	52						
	240	12,5	53									

KONVERTER MINI JOLLY DALI 20	INFORMATION						W	mA	V DC	L x B x H	FARBE	ART.NR.
 Konverter, DALI dimmbar, 230 V AC Einstellbar mittels DIP-SWITCH: Konstantstrom	mA	W	V DC	mA	W	V DC	12-20	250-700	49-28	111 x 52 x 22	weiß	24-151403
	250	12	49	500	20	40						
	350	17	49	550	20	36						
	400	19	49	600	20	33						
	450	20	45	700	20	28						





## KONSTANTSTROM KONVERTER DIMMBAR

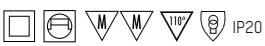

KONVERTER MINI JOLLY LC DALI	INFORMATION	W	mA	V DC	L x B x H	FARBE	ART.NR.	
	Konverter, DALI dimmbar, 230V AC Einstellbar mittels DIP-SWITCH: Konstantstrom	5,3-20	100-380	54-51	111 x 52 x 22	weiß	24-123395	
	<b>mA</b>	<b>W</b>	<b>V DC</b>	<b>mA</b>	<b>W</b>	<b>V DC</b>		
	100	5,3	53	260	14	52		
	140	7,5	53	300	16	52		
	180	9,5	53	340	18	51		
	220	12	53	380	20	51		
								

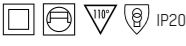

KONVERTER PROFESSIONALE DALI 36	INFORMATION	W	mA	V DC	L x B x H	FARBE	ART.NR.	
	Konverter, DALI dimmbar, 230 V AC Einstellbar mittels DIP-SWITCH: Konstantstrom	16-38	300-1050	54-36	147 x 44 x 30	weiß	24-127490	
	<b>mA</b>	<b>W</b>	<b>V DC</b>	<b>mA</b>	<b>W</b>	<b>V DC</b>		
	300	16	54	700	38	54		
	350	18	54	750	38	51		
	400	21	54	800	38	48		
	450	24	54	850	38	45		
	500	27	54	900	38	42		
	550	29	54	950	38	40		
	600	32	54	1000	38	38		
	650	35	54	1050	38	36		
								



KONVERTER MAXI JOLLY SV DALI 50	INFORMATION	W	mA	V DC	L x B x H	FARBE	ART.NR.	
	Konverter, 1-10V, PUSH & DALI dimmbar, 240V AC Einstellbar mittels DIP-SWITCH:	18,5-50	350-1200	53-41	124 x 79 x 22	weiß	24-151504	
	<b>mA</b>	<b>W</b>	<b>V DC</b>	<b>mA</b>	<b>W</b>	<b>V DC</b>		
	350	18,5	53	800	39,5	53		
	400	21	53	850	42	53		
	450	23,5	53	900	45	53		
	500	26,5	53	950	47,5	52		
	550	29	53	1000	50	50		
	600	31,5	53	1050	50	48		
	650	34,5	53	1100	50	45		
	700	34,5	53	1150	50	43		
	750	37	53	1200	50	41		
								



KONV. PROFESSIONALE IN DALI 20	INFORMATION	W	mA	V DC	L x B x H	FARBE	ART.NR.	
	Konverter, PUSH & DALI dimmbar, 230V AC, doppelte Anschluss- und DALI-Klemmblöcke für Durchgangsverdrahtung Einstellbar mittels DIP-SWITCH:	6,8-20	125-500	54-40	132 x 79 x 30	grau	24-127508	
	<b>mA</b>	<b>W</b>	<b>V DC</b>	<b>mA</b>	<b>W</b>	<b>V DC</b>		
	125	6,8	54	325	17,5	54		
	150	8	54	350	19	54		
	175	9,4	54	375	20	54		
	200	10,8	54	400	20	54		
	225	12,15	54	425	20	47		
	250	13,5	54	450	20	44		
	275	14,8	54	475	20	42		
	300	16	54	500	20	40		
								



## KONSTANTSTROM KONVERTER DIMMBAR



KONVERTER PROFESSIONALE IN DALI 40	INFORMATION	W	mA	V DC	L x B x H	FARBE	ART.NR.	
	Konverter, PUSH & DALI dimmbar, 230V AC, doppelte Anschluss- und DALI-Klemmblöcke für Durchgangsverdrahtung Einstellbar mittels DIP-SWITCH:	16,2-40	300-1050	54-38	132 x 80 x 30	grau	24-127481	
	<b>mA</b>	<b>W</b>	<b>V DC</b>	<b>mA</b>	<b>W</b>	<b>V DC</b>		
	300	16,2	54	700	37,8	54		
	350	19	54	750	40	54		
	400	21,6	54	800	40	50		
	450	24,3	54	850	40	47		
	500	27	54	900	40	45		
	550	29,7	54	950	40	42		
	600	32,4	54	1000	40	40		
	650	35,1	54	1050	40	38		
								



KONVERTER PROFESSIONALE IN DALI 52	INFORMATION	W	mA	V DC	L x B x H	FARBE	ART.NR.	
	Konverter, PUSH & DALI dimmbar, 230V AC, doppelte Anschluss- und DALI-Klemmblöcke für Durchgangsverdrahtung Einstellbar mittels DIP-SWITCH:	27,3-52	650-1400	42-37,5	132 x 79 x 30	grau	24-127485	
	<b>mA</b>	<b>W</b>	<b>V DC</b>	<b>mA</b>	<b>W</b>	<b>V DC</b>		
	650	27,3	42	1050	42	40		
	700	29,4	42	1100	42,9	39		
	750	30,7	41	1150	44,8	39		
	800	32,8	41	1200	46,8	39		
	850	34,8	41	1250	47,5	38		
	900	36	40	1300	49,4	38		
	950	38	40	1350	51,3	38		
	1000	40	40	1400	52	37,5		
								

KONVERTER FÜR PANELLEUCHE FIT	INFORMATION	SCHALTBAR / DIMMBAR	mA	L x B x H	FARBE	ART.NR.
	Konverter 230V AC, für Panelleuchte FIT, inkl. MOLEX Steckverbindung	schaltbar	900	103 x 67 x 30	weiß	757-k900s
		schaltbar	1200	130 x 43 x 30	weiß	757-k1200s
		DALI dimmbar	900	110 x 75 x 25	weiß	757-k900d
		DALI dimmbar	1200	171 x 81 x 30	weiß	757-k1200d
						

SYNCHRONISATIONSKABEL FÜR MAXI JOLLY	INFORMATION	L	FARBE	ART.NR.
	Für MAXI JOLLY Konverter	1500	weiß	24-485720512
				

## KONSTANTSPANNUNGSKONVERTER





KONVERTER VST	INFORMATION	W	V DC	L x B x H	FARBE	ART.NR.
	Konverter für Strips, nicht dimmbar, 230 V AC	50	24	225 x 60 x 36	weiß	24-122752
		70	24	225 x 60 x 36	weiß	24-122750
		150	24	240 x 60 x 49	weiß	24-122754n
						

## KONSTANTSPANNUNGSKONVERTER



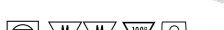





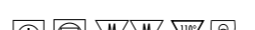

KONVERTER SLIM/U	INFORMATION	W	V DC	L x B x H	FARBE	ART.NR.	
	Konverter für Strips, nicht dimmbar, 230 V AC	13	24	158 x 22 x 19	weiß	24-141122	
							
KONVERTER EFU	INFORMATION	W	V DC	L x B x H	FARBE	ART.NR.	
	Konverter für Strips, nicht dimmbar, 230 V AC	25	24	146 x 55 x 19	weiß	24-141126	
							
KONVERTER VPS LP	INFORMATION	W	V DC	L x B x H	FARBE	ART.NR.	
	Konverter für Strips, nicht dimmbar, 230 V AC	50 75	24	167 x 59 x 28,5 184 x 61 x 28,5	weiß	24-127903 24-127905	
							
KONVERTER LCV	INFORMATION	W	V DC	V AC	L x B x H	FARBE	ART.NR.
	Konverter für Stripes nicht dimmbar, 230V AC schaltbar	60W 120W	24	230	180 x 52 x 30 300 x 40 x 30	weiß	24-127821 24-127824
							
KONVERTER ST2 IP67	INFORMATION	W	V DC	L x B x H	FARBE	ART.NR.	
	Konverter für Strips, nicht dimmbar, 230 V AC	70 150	24	225 x 66 x 51	schwarz	24-122479 24-122511	
							
KONVERTER ELG IP67	INFORMATION	W	V DC	L x B x H	FARBE	ART.NR.	
	Überlastschutz durch Strombegrenzung geschützt gegen Kurzschluss mit automatischen Wiederanlauf, Überlast, Überspannung eingebauter aktiver PFC-Schaltkreis, 240W, 24V	240	24	244 x 71 x 38	grau	647-elg24024	
							

KONVERTER DC 50W 48V VST	INFORMATION	W	V DC	V AC	L x B x H	FARBE	ART.NR.
	nicht dimmbar	50W	48	230	225 x 60 x 49	weiß	24-122766
							

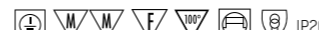

DC 150W 48V VST KONVERTER	INFORMATION	WATT	V DC	V AC	L x B x H	FARBE	ART.NR.
	nicht dimmbar	150W	48	230	240 x 60 x 49	weiß	24-122764
							

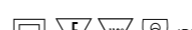

## KONSTANTSPANNUNGSKONVERTER DIMMBAR

















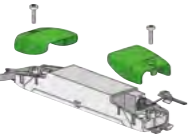

KONVERTER VSTR 1-10V / PUSH / IR	INFORMATION	W	V DC	L x B x H	FARBE	ART.NR.	
	Konverter für Strips, dimmbar 1-10V & Push Dimm., IR-Zubehör separat ordern (IR-Empfänger inkl. 2m Kabel 24-122093 + IR-Fernbedienung 24-150120A)	3x 40 (RGB) 1x 100 weiß	24	240 x 60 x 49	weiß	24-122730	
							
KONVERTER QT DALI	INFORMATION	W	V DC	V AC	L x B x H	FARBE	ART.NR.
	Konverter für Stripes DALI dimmbar, 230V AC	50W 80W 160W	24	230	346 x 32 x 22 346 x 32 x 22 300 x 50 x 35	weiß	28-177900 28-177924 28-177948
							
DALI / PUSH KONVERTER	INFORMATION	W	V DC	V AC	L x B x H	FARBE	ART.NR.
	Konverter für Stripes, dimmbar DALI Push Dimm. 1 KANAL	150W	24	230	365 x 43 x 30	weiß	711-241501dt6
							
DALI DT8 / PUSH KONVERTER	INFORMATION	W	V DC	V AC	L x B x H	FARBE	ART.NR.
	Konverter für Stripes, dimmbar DALI DT8 Push Dimm. 2 KANAL	75W	24	230	486 x 31 x 31	graphit	711-24752dt8
							
DALI / PUSH KONVERTER	INFORMATION	W	V DC	V AC	L x B x H	FARBE	ART.NR.
	Konverter für Stripes, dimmbar DALI Push Dimm. 2 KANAL	30W	24	230	170 x 54 x 54	weiß	711-24302dt6
							













## DALI-STEUERUNG ZUBEHÖR

DALI REPEATER SO DALI STEUERGERÄT	INFORMATION	L x B x H	ART.NR.
	DALI Signalverstärker (Repeater) Erweiterung von DALI Anlagen um jeweils 64 EVG Die an den Repeater angeschlossenen EVG arbeiten als Gruppe Touch DIM Steuerung von jeweils 64 DALI EVG (ohne integrierten Lastkontakt) für Leuchteneinbau	189 x 30 x 21	28-292599
			

DALI REPEATER SO DALI STEUERGERÄT	INFORMATION	L x B x H	ART.NR.
	DALI-Signalverstärker / Steuergerät mit TOUCH-DIMM, Eingang für max. 64 DALI EVG, Ansteuerung mit jedem handelsüblichen Taster, der DALI-Ausgang erlaubt die Ansteuerung von OSRAM fremden DALI-EVG's (Philips, Tridonic usw.), mit TOUCH-DIMM Funktion, 230V, 50-60Hz	72 x 96 x 62	28-301093
			

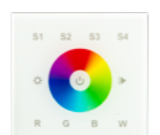
## DALI-STEUERUNG ZUBEHÖR



DALI MCU TW G2 STEUERGERÄT	INFORMATION	B x H x ET	BLENDE B x H	ART.NR.
	DALI MCU Drehregler für max. 25 DALI EVG's, ermöglicht manuelles Dimmen über DALI und Steuerung der Farbtemperatur mittels DALI DT8 tunable white, bis zu 4 DALI MCU sind parallel verwendbar, Kompatibel mit Abdeckungen von Jung, Berker, Siemens, Gira und Schneider Electric - für genauere Informationen benutzen Sie bitte den aktuellen OSRAM Katalog oder Montageanleitung, 230V / 50-60Hz, inkl. Blende (81x81mm) cremeweiß	71 x 71 x 50	81 x 81	28-224673
				
DALI PCU STEUERGERÄT	INFORMATION	L x B x H	ART.NR.	
	DALI PCU Steuergerät (Eingang Taster / Ausgang DALI für 25 DALI Geräte) für Einbau in UP-Dose	48 x 48 x 22	28-955622	
				
DALIECO CONTROL STEUERGERÄT	INFORMATION	L x B x H	ART.NR.	
	2-Kanal-Lichtsteuergerät mit DALI-Schnittstelle; Anschluss für bis zu 32 elektronische Vorschaltgeräte möglich Ausgänge mit elektronisch reversiblen Über-temperatur-, Kurzschluss-, Überlastschutz	118 x 30 x 21	28-988645	
				
DALIECO CI KIT	INFORMATION	ART.NR.		
	Zugentlastungskit für DALIECO CONTROL Steuergerät notwendig bei externer Montage von Steuergerät DALIECO CONTROL [Deckeneinbau]	28-392091		
				
DALIECO LS/PD LI	INFORMATION	L x B x H	ART.NR.	
	Licht- & Präsenzsensoren für Arbeitsplätze Präsenzerfassung über passives IR-Element, Präsenzerfassungsbereich über integrierte Shutter zwischen 40...90° einstellbar, Funktionsanzeige mit zweifarbiger, Integrierter Infrarot-Fernbedienungs-Empfänger; maximale Installationshöhe 5m, für externe Montage Zubehör separat bestellen	48 x 15 x 17	28-988652	
				
DALIECO DECKENEINBAUADAPTER	INFORMATION	Ø x H x DA	ART.NR.	
	Deckeneinbauadapter für DALIECO Sensoren [LS/PD]	80 x 36 x 68	28-920293	
				
DALIECO DECKENAUFBAUGEHÄUSE	INFORMATION	L x B x H	ART.NR.	
	Aufbaugehäuse für DALIECO Sensoren [LS/PD]	65 x 65 x 34	28-173385	
				
DALIECO REMOTE KIT MASTER	INFORMATION	L x B x H	ART.NR.	
	Fernbedienung [Master] für die Konfiguration und Inbetriebnahme des DALIECO Lichtsteuerungssystems; Digitale IR-Übertragung mit Reichweite bis 10m, s zur Anzeige von Betriebs- und Programmiermodus und Signalübertragung, mit PC-Schnittstelle; im Lieferprogramm sind enthalten: Fernbedienung, 2 Stück Knopfzellen Typ CR2032, USB Verbindungskabel, DALIECO PC Software	230 x 45 x 13	28-195967	
				

RGBW FUNK DIMMER	INFORMATION	W	V DC	L x B x H	FARBE	ART.NR.	
	4-Kanal Funk Dimmer zur Ansteuerung von RGBW, RGB oder weißen Stripes max. 5A/ Kanal, Spannungsversorgung separat ordern	240-720	12-36	179 x 46 x 19	weiß	711-000305	
							
DMX RGBW DIMMER	INFORMATION	V DC	L x B x H	FARBE	ART.NR.		
	RGBW Dimmer 12-36V DMX, 12V - 36V DC, geeignet zur Steuerung von RGBW Stripes, max. 5A / Kanal	12-36	178 x 46 x 19	weiß	711-000705		
							
UNIVERSALDIMMER	INFORMATION	V DC	L x B x H	FARBE	ART.NR.		
	Universaldimmer 1 Kanal, separater Steuereingang für DALI, 1-10V, Push, Sync Anschluß für bis zu 9 Slaves bei 1-10V oder Push Ansteuerung, max. Anschluß: 5A Zugentlastung separat ordern <b>ZUGENTLASTUNG</b> für 1-Kanal Universaldimmer, 2 Stück	12-50	153 x 30 x 21	weiß	322-ud3000	322-ud7001	
							
DALI DT8 / PUSH DIMMER - 4 KANAL	INFORMATION	W	V DC	V AC	L x B x H	FARBE	ART.NR.
	Dimmer für Stripes, DALI DT8 für RGB/W und tunable white, Konverter separat ordern	60-180W	12-36	230	170 x 54 x 28	weiß	711-24180dt8
							
LICHTSZENEKONTROLLER DALI	INFORMATION	V AC	L x B x H	FARBE	ART.NR.		
	Lichtszenecontroller DALI DT8 für RGB/W Stripes, 4 Szenen konfigurierbar, zur Montage in Standard-Einbaudose Ø 68mm	230	86 x 86 x 41	weiß	711-01230d8rgbw		
							
	Lichtszenecontroller DALI DT8 für tunable white Stripes, 4 Szenen konfigurierbar, zur Montage in Standard-Einbaudose Ø 68mm	230	86 x 86 x 41	weiß	711-01230d8tw		
							

## FUNK-STEUERUNG

LICHTSZENENKONTROLLER	INFORMATION	FÜR	V DC	B x H x T	FARBE	ART.NR.
	RGBW Funk Controller für bis zu 4 Zonen, bis zu 4 Stimmungen, Geschwindigkeit und Helligkeit kann angepasst werden, - Steuereinheit kann auf Standard EB-Dose 68mm montiert werden	DMX	12-24	86 x 86 x 10	schwarz	711-000806
		WIFI/FUNK	12-24	86 x 86 x 10	schwarz	711-000606
WLAN GATEWAY	INFORMATION	V DC	B x H x T	FARBE	ART.NR.	
	WLAN Gateway, zur Ansteuerung von 711-000305, dazugehöriges App. EASYColor Pro im Appstore bzw. Playstore kostenlos erhältlich, Integration in hauseigenes WLAN möglich.	12-24	110 x 85 x 24,2	schwarz	711-000406	
FUNK FERNBEDIENUNG	INFORMATION	L x B x T	FARBE	ART.NR.		
	Funk Fernbedienung für bis zu 4 Zonen, bis zu 4 Stimmungen, Geschwindigkeit und Helligkeit kann angepasst werden, inkl. Wandhalterung	140 x 48 x 16	schwarz	711-000506		
FUNK FERNBEDIENUNG	INFORMATION	L x B x H	FARBE	ART.NR.		
	Funk Fernbedienung mit Farbrad zur einfachen Tunable White Steuerung, 2 Lichtfarben können gespeichert werden, 2 Szenen-Wahl, Dimmstufen in 25% Schritten abrufbar	120 x 48 x 18	weiß	711-001106		
FUNK FERNBEDIENUNG	INFORMATION	L x B x H	FARBE	ART.NR.		
	Funk Fernbedienung für bis zu 5 Zonen zur Dimmung der Helligkeit, Fernbedienung kann mit bis zu 8 verschiedenen Empfängern arbeiten	136 x 39 x 11	schwarz	711-000906		
FUNK DIMMER TUNABLE WHITE	INFORMATION	W	V DC	L x B x H	FARBE	ART.NR.
	2-Kanal Funk Dimmer zur Ansteuerung von Tunable White Stripes max. 5A/Kanal, Spannungsversorgung separat ordern	110 - 240	12 - 24	145 x 47 x 16	weiß	711-001005

## BLUETOOTHSTEUERUNG











PUSH BUTTON INTERFACE	INFORMATION	V AC	L x B x H	FARBE	ART.NR.		
	Zur Integration von handelsüblichen Tastern in die MOLTO LUCE Smart App BLUETOOTH Dimm. 3 Kanal UP-Dosenmodul	230	43 x 43 x 18	blau	701-1005		
BLUETOOTH DIMMER-2 KANAL	INFORMATION	W	V DC OUT	V DC OUT	L x B x H	FARBE	ART.NR.
	SED DCC 2CH BLL Konverter, PWM-dimmbar, Draht Querschnitt bis zu 2,5mm, Schutz gegen Überhitzung und Kurzschluss, Netzüberspannungen, Überlast, Deckeneinlegeausschnitt=40mm, I out = 4,5A max.	2x 55W 1x 110W	2 x 24	24	115 x 34 x 19	blau	701-1004
INTERFACE SMART BLUETOOTH TO DALI	INFORMATION	V AC	L x B x H	FARBE	ART.NR.		
	Zur Integration von max. 40 Dali dimmbaren Leuchte in die MOLTO LUCE Smart App, BLUETOOTH Dimm. Smart BLUETOOTH to DALI	230	85 x 30 x 22	blau	701-1003		
MOLTO LUCE SMART APP	INFORMATION						



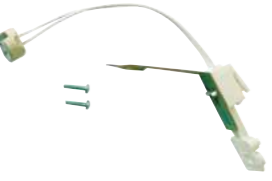

Die Molto Luce Smart APP ist ihr System zur Lichtsteuerung, egal ob einzelne Gruppen, ganze Netzwerke, Szenen, Zeitsteuerungen und komplexe Lösungen wie Heatmapping. Die Molto Luce Smart APP stellt ihnen alle Möglichkeiten zur Verfügung.  
**DOWNLOAD IM APP ODER PLAY STORE**

SMART APP BEDIENUNGSANLEITUNG:





PG KLEMMROHR	INFORMATION	L x Ø	FARBE	ART.NR.
 	<p>Klemmrohr mit PG Verschraubung für Wasserdichte Kabelverbindungen, 3-poliger Block, Verwendung nur mit Kabel H05SS-F, für Kabel Ø 7-12 mm für max. 24A / 450V AC</p> <p>IP68</p>	66 x 23	schwarz	102-thb391a3c
PG KLEMMROHR Y-FORM	INFORMATION	L x B x Ø	FARBE	ART.NR.
 	<p>Klemmrohr mit PG Verschraubung für Wasserdichte Kabelverbindungen, 3-poliger Block, Verwendung nur mit Kabel H05SS-F, für Kabel Ø 7-13,5 mm für max. 24A / 450V AC</p> <p>IP68</p>	180 x 65,5 x 34	schwarz	102-thb399a3c
FASSUNG GU5,3	INFORMATION	L	ART.NR.	
  	<p>mit Klemme und Zugentlastung 12V NV</p>	115	259-502990	
FASSUNG GU10	INFORMATION	ART.NR.		
  	<p>mit Klemme und Zugentlastung 230V HV</p>	259-502991		

LED RETROFIT	INFORMATION	FASSUNG	WATT	KELVIN	ENERGIEEFFIZIENZ	AUSSTRAHLWINKEL	ART.NR.
	ST64 / MASTER VLE LED Bulb klar	E27	6W	927	D	270	<b>30-347960</b>
	A60 / CorePro LED Bulb klar	E27	4W	827	F	>300	<b>30-347168</b>
	A60 / CorePro LED Bulb klar	E27	7W	827	E	>300	<b>30-380035</b>
	G120 / MASTER VLE LED Bulb klar	E27	6W	927	D	>300	<b>30-347984</b>
	A60 / MASTER VLE LED Bulb klar	E27	6W	922-927	D	>300	<b>30-324732</b>
	G200 / Classic LED Bulb gold	E27	7W	818	F	>300	<b>30-313781</b>

LED RETROFIT	INFORMATION	FASSUNG	WATT	KELVIN	ENERGIEEFFIZIENZ	AUSSTRAHLWINKEL	ART.NR.
	A60 / Master LED Bulb klar	E27	6W	822-827	F	>300	<b>30-306301</b>
	A60 / Master LED Bulb matt	E27	7W	922-927	D	200	<b>30-324930</b>
	A60 / Master LED Bulb matt	E27	11W	922-927	D	>300	<b>30-325012</b>

LED RETROFIT	INFORMATION	FASSUNG	WATT	KELVIN	ENERGIEEFFIZIENZ	AUSSTRAHLWINKEL	ART.NR.
	Master LED Spot	E27	6W	827	F	25	<b>30-768461</b>
	Master LED Spot	E27	6W	830	F	25	<b>30-768485</b>

LED RETROFIT	INFORMATION	FASSUNG	WATT	KELVIN	ENERGIEEFFIZIENZ	AUSSTRAHLWINKEL	ART.NR.
	Master LED Spot	E27	10W	827	F	25	<b>30-768607</b>

LED RETROFIT	INFORMATION	FASSUNG	WATT	KELVIN	ENERGIEEFFIZIENZ	AUSSTRAHLWINKEL	ART.NR.
	Master LED Spot	E27	13W	827	F	25	<b>30-768706</b>

LED RETROFIT	INFORMATION	FASSUNG	WATT	KELVIN	ENERGIEEFFIZIENZ	AUSSTRAHLWINKEL	ART.NR.
	B35 / CorePro LED Candle	E14	2W	827	E	>300	<b>30-377578</b>
	CorePro LED Luster	E14	2W	827	E	>300	<b>30-347748</b>

LED RETROFIT	INFORMATION	FASSUNG	WATT	KELVIN	ENERGIEEFFIZIENZ	AUSSTRAHLWINKEL	ART.NR.
	B38 / Master LED Candle klar	E14	3W	822-827	F	>300	<b>30-306028</b>
	B38 / Master LED Candle klar	E14	6W	822-827	F	>300	<b>30-306141</b>
	P48 / Master LED Luster klar	E14	3W	822-827	F	>300	<b>30-306066</b>
	P48 / Master LED Luster klar	E14	6W	822-827	F	>300	<b>30-306189</b>

LED RETROFIT	INFORMATION	FASSUNG	WATT	KELVIN	ENERGIEEFFIZIENZ	AUSSTRAHLWINKEL	ART.NR.
	Core Pro LED Spot	GU10	4W	827	F	36	<b>30-752531</b>
	Master LED Spot VLE	GU10	4W	922-927	F	36	<b>30-312289</b>
	Master LED Spot Expert Colour	GU10	4W	930	G	25	<b>30-707517</b>
	Master LED Spot Expert Colour	GU10	4W	930	G	36	<b>30-707579</b>
	MASTER LED SPOT VLE	GU10	5W	922-927	F	36	<b>30-708118</b>
	Master LED Spot Expert Colour	GU10	6W	930	G	25	<b>30-707630</b>
	Master LED Spot Expert Colour	GU10	6W	930	G	36	<b>30-707692</b>
	Core Pro LED Spot	GU10	5W	827	F	36	<b>30-752517</b>

LED RETROFIT	INFORMATION	FASSUNG	WATT	KELVIN	ENERGIEEFFIZIENZ	AUSSTRAHLWINKEL	ART.NR.
	MR16 Core Pro LED Spot	GU 5,3	4W	827	F	36	<b>30-307063</b>
	MR16 / MASTER LED Spot VLE	GU 5,3	6W	927	G	36	<b>30-307186</b>
	MR16 / MASTER LED Spot VLE	GU 5,3	6W	930	F	36	<b>30-307209</b>
	MR16 / MASTER LED Spot VLE	GU 5,3	8W	927	F	36	<b>30-307322</b>

LED RETROFIT	INFORMATION	FASSUNG	WATT	KELVIN	ENERGIEEFFIZIENZ	AUSSTRAHLWINKEL	ART.NR.
	Master LED Spot Expert Colour	G53	11W	927	G	24	<b>30-333932</b>
	Master LED Spot Expert Colour	G53	11W	930	G	24	<b>30-333994</b>
	Master LED Spot Expert Colour	G53	11W	927	G	40	<b>30-333956</b>
	Master LED Spot Expert Colour	G53	15W	930	G	40	<b>30-334014</b>
	Master LED Spot Expert Colour	G53	15W	927	G	40	<b>30-333819</b>
	Master LED Spot Expert Colour	G53	15W	930	G	40	<b>30-333857</b>
	Master LED Spot Expert Colour	G53	20W	927	G	24	<b>30-705114</b>
	Master LED Spot Expert Colour	G53	20W	930	G	24	<b>30-705152</b>
	Master LED Spot Expert Colour	G53	20W	927	G	45	<b>30-705138</b>
	Master LED Spot Expert Colour	G53	20W	930	G	45	<b>30-705176</b>

LED RETROFIT	INFORMATION	FASSUNG	WATT	KELVIN	ENERGIEEFFIZIENZ	AUSSTRAHLWINKEL	ART.NR.
	Core Pro LED Capsule	G9	2W	827	E	300	<b>30-303898</b>
	Core Pro LED Capsule	G9	3W	827	E	300	<b>30-303935</b>
	Core Pro LED Capsule	G9	5W	827	E	300	<b>30-657802</b>

LED RETROFIT	INFORMATION	FASSUNG	WATT	KELVIN	ENERGIEEFFIZIENZ	AUSSTRAHLWINKEL	ART.NR.
	Core Pro LED Capsule	G4	1W	827	F	300	<b>30-767617</b>
	Core Pro LED Capsule	G4	2W	827	F	300	<b>30-767655</b>
	Core Pro LED Capsule	G4	3W	827	F	300	<b>30-767754</b>

LED RETROFIT	INFORMATION	FASSUNG	WATT	KELVIN	ENERGIEEFFIZIENZ	AUSSTRAHLWINKEL	ART.NR.
	Core Pro LED Linear 118mm	R7s	14W	830	E	300	<b>30-578797</b>
	Core Pro LED Linear 118mm	R7s	18W	830	D	300	<b>30-646738</b>
	Core Pro LED Linear 78mm	R7s	8W	830	E	300	<b>30-713945</b>
	Core Pro LED Linear 118mm	R7s	7W	830	E	300	<b>30-303973</b>

## HINWEISE FÜR BODENEINBAUSTRALER

### Allgemeine Hinweise

Die Auswahl von Bodeneinbaustrahlern wird von wichtigen Kriterien bestimmt, wie etwa Oberflächentemperatur (Verletzungsgefahr) oder Einbauort (Innen / Außen) und Belastungsanforderung (begehrbar / überrollbar). Diese sind grundsätzlich von einem Fachmann zu beurteilen, dennoch hier eine kurze Erklärung: Begehrbar heißt, dass der Strahler der statischen Belastung standhält, die ein Mensch beim Darübergehen verursacht. Überrollbar bedeutet, dass ein Fahrzeug darüberrollen darf. Bremsvorgänge und Lenkbewegungen sind aber auf dem Bodeneinbaustrahler nicht erlaubt, da sie eine enorme Belastung darstellen. Die Belastbarkeit wird im Datenblatt angegeben. z.B.: 2000kg bei max. 20 km/h. Es dürfen keine Lasten dauerhaft auf einem Strahler verbleiben. Halten und Parken auf einem Strahler ist daher nicht erlaubt.

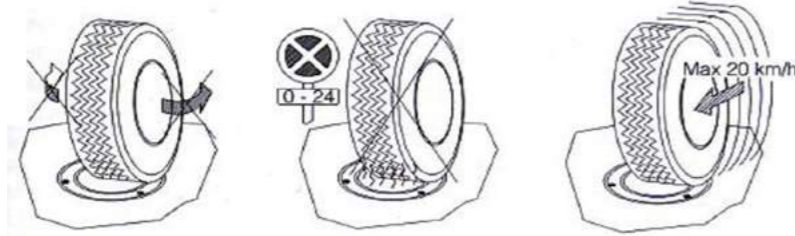

Vor dem Einbau eines Strahlers ist zusätzlich die originale Einbauanleitung zu lesen, um etwaige Besonderheiten oder Eigenschaften eines Strahlers kennenzulernen. Grundsätzlich ist die professionelle Montage von Bodeneinbaustrahlern eine Präzisionsarbeit. Das erfordert Zeit und einen ordentlichen Arbeitsablauf, tadelloses Werkzeug ist Voraussetzung. Trockene Witterungsverhältnisse sind bei der Montage von Vorteil.

### Bodeneinbaustrahler im Außenbereich - Schutzart IP67 / IP68 - Bedeutung

Die Schutzart eines Bodeneinbaustrahlers betrifft nur den Strahler selbst, nicht aber das Einbaugeschäule, in welches der Strahler montiert wird. Das Betoneinbaugeschäule dient lediglich als äußeres Gehäuse, das einbetoniert wird. Dieses Gehäuse kann aus Metall oder Kunststoff sein, und dient zur mechanischen Befestigung des Strahlers. In der Fuge zwischen Strahler und Gehäuse kann demnach Wasser eindringen. Es ist wichtig, dass dieses Wasser im Boden rasch ablaufen kann, und der Bodeneinbaustrahler nicht im Wasser steht. Durch die Hitzeentwicklung bei eingeschaltetem Strahler herrscht im Inneren ein Überdruck, die heiße Luft dehnt sich also aus und entweicht. Wird der Strahler abgeschaltet, so kühlt er ab, und es entsteht im Inneren ein Unterdruck, es wird Luft angesaugt. Steht der Strahler aber im Wasser, so wird Wasser angesaugt!

### Das Einbaugeschäule

Manche Hersteller fertigen ihre Bodeneinbaugeschäule nach unten offen, was den Wasserablauf deutlich begünstigt.



Andere Hersteller fertigen geschlossene Einbaugeschäule, die keinen ordentlichen Wasserablauf erwarten lassen, aber Vorteile beim Einbau im Innenbereich haben (Eindringen von Beton). Bei Verwendung im Außenbereich ist es hier notwendig, bauseits eine entsprechend große Öffnung in den Boden des Einbaugeschäules zu schneiden, um einen raschen Wasserablauf zu ermöglichen.

### Drainage

Jede Drainage muss vor Installation der Leuchte auf Funktionsfähigkeit überprüft werden! Füllen sie zu diesem Zweck das Einbaugeschäule mit Wasser, nach spätestens 30 Minuten muss das Gehäuse leer sein, ansonst ist die Drainage unzureichend!



### Kiesdrainage

Unter dem Einbaugeschäule wird eine 20-30cm dicke Kiesschicht aufgefüllt, die ein Abfließen des in das Einbaugeschäule eingedrungenes Wasser gewährleistet! Achtung: Sand, Bauschotter oder dergleichen sind für eine Drainage aufgrund der zu geringen Abflussgeschwindigkeit ungeeignet.

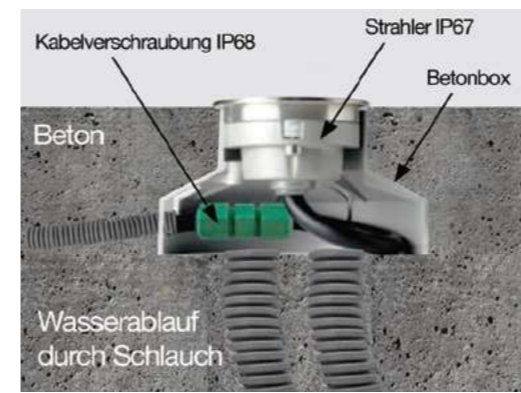

### Keine Kiesdrainage - Wasserablauf durch Schlauch

Falls es nicht möglich ist eine Kiesdrainage herzustellen (z.B. Balkon) muss der Wasserablauf durch einen Schlauch gewährleistet werden. Dieser muss ausreichend dimensioniert sein und darf nicht durch Verschmutzung verstopfen.

### Bodenmaterial - Bodenbelag

Das Einbaugeschäule darf durch den Einbau keinesfalls in seiner Form verbogen, gestaucht etc. werden. Besondere Vorsicht ist hier bei Steinplatten geboten. Wird das Gehäuse verbogen, kann der Befestigungsring des Schutzglases klemmen, und der Strahler kann somit undicht werden.

### Die Anschlussleitung

hier ist ausschließlich ein Kabel der Type H07RN-F oder H07RN8-F zu verwenden. Jedes andere Kabel wird gemeinsam mit der Kabelverschraubung nicht dicht werden, da es bei Kälte nicht flexibel ist.

### H07 RN-F



### H07 RN8-F



### Kabelverbindungen

sind einfach und dauerhaft mit IP68 Klemmrohren auszuführen. Kabeldurchmesser beachten. Es darf im Strahler keine zusätzliche Bohrung für eine weitere Kabelverschraubung vorgenommen werden.



### Betriebsgeräte

Einige Bodeneinbaustrahler sind besonders klein, und haben aus Platzgründen oder thermischen Gründen das Betriebsgerät nicht eingebaut, benötigen also ein externes Betriebsgerät. Im Innenbereich kann das Betriebsgerät in das Einbaugeschäule gelegt werden (Achtung Wärme). Im Außenbereich gehört das Betriebsgerät aber nicht in das Einbaugeschäule des Strahlers, dort hat es nichts verloren, denn das Betriebsgerät könnte dort im Wasser liegen. Es gehört daher in einen Subverteiler oder einen Verteilerkasten, der an geeigneter Stelle montiert ist.

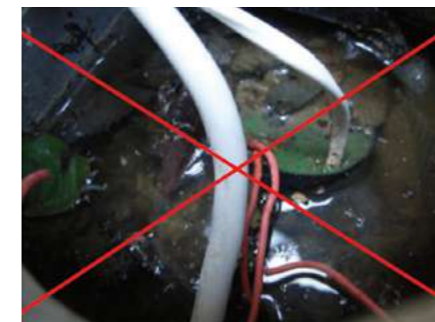

### Reinigung der Dichtflächen

Die Dichtung und die Dichtflächen müssen vor dem Einbau gereinigt werden, am besten mit Alkohol oder einem geeigneten Lösungsmittel. Anschließend sind die Dichtung und die Dichtflächen mit einem dünnen Film Vaseline einzufetten. Wichtig: Anschließend nicht mehr beschmutzen: Sand, Staub, Fasern etc.

### Die Befestigungsschrauben

Befestigungsschrauben, welche das Glas oder den Befestigungsring mit der Dichtung an die Dichtfläche pressen, müssen leichtgängig sein und ein unbeschädigtes Gewinde aufweisen. Die Befestigungsschrauben sind jeweils gegenüberliegend anzuziehen, am Besten in 2-3 Durchgängen mit jeweils gesteigertem Drehmoment. Bei Nichtbeachtung sinkt die mechanische Belastbarkeit drastisch und das Glas kann zerspringen. Eventuelle Angaben zum Drehmoment berücksichtigen. Falls der Hersteller keine Angaben macht die Schrauben gefühlvoll, aber handfest anziehen.

### Leuchtmittel wechseln

Nach dem Leuchtmittelwechsel müssen Glas und Dichtung gereinigt werden. Beim Einsetzen der Dichtung Vaseline benützen.

### Dichtungen

Falls es vom Hersteller Ersatzdichtungen für den Strahler gibt, ist es sinnvoll, bei defekten, alten Dichtungen diese gegen neue auszutauschen. Abdichtungen mit Fugensilikon sind bei einem Bodeneinbaustrahler völlig sinnlos und daher zu unterlassen!

IP - SCHUTZARTEN		
1. Ziffer	Berührungsschutz	Schutz gegen das Eindringen von Fremdkörpern und Staub
IP 0X	ungeschützt	kein besonderer Schutz
IP 1X	Schutz gegen Fremdkörper > 50 mm	Größere Körperteile wie eine Hand (jedoch keine Schutzmaßnahme gegen bewusste Berührung)
IP 2X	Schutz gegen Fremdkörper > 12 mm	Finger und dergleichen bis 80 mm Länge; Fremdkörper >12 mm Durchmesser
IP 3X	Schutz gegen Fremdkörper > 2,5 mm	Werkzeuge, Drähte usw. mit Durchmesser oder Dicke > 2,5 mm; Fremdkörper > 2,5mm
IP 4X	Schutz gegen Fremdkörper > 1 mm	Drähte oder Streifen > 1mm; Fremdkörper > 1 mm Durchmesser
IP 5X	Staubschutz	Eindringen von Staub wird nicht völlig verhindert, aber Staub dringt nicht in solchen Mengen ein, dass ordnungsgemäßer Betrieb behindert wird.
IP 6X	Staubdicht	kein Eindringen von Staub
2. Ziffer	Wasserschutz	Schutz gegen das Eindringen von Wasser
IP X0	ungeschützt	kein besonderer Schutz
IP X1	Schutz gegen Tropfwasser	Tropfwasser (senkrecht fallende Tropfen) verursacht keine Schädigung.
IP X2	Schutz gegen Tropfwasser unter 15°	Senkrecht fallende Tropfen dürfen keine Schädigung bewirken, wenn das Gehäuse bis zu 15° aus seiner bestimmungsgemäßen Gebrauchslage gekippt wird.
IP X3	Schutz gegen Sprühwasser	Sprühwasser darf aus einer Neigung bis 60° gegen die Senkrechte keine Schädigung verursachen.
IP X4	Schutz gegen Spritzwasser	Spritzwasser aus beliebiger Richtung darf keine Schädigung verursachen
IP X5	Schutz gegen Strahlwasser	Strahlwasser aus einer Düse aus einer Richtung darf keine Schädigung verursachen.
IP X6	Schutz gegen schwere See	Schwere See oder Strahlwasser unter hohem Druck dürfen nicht in gefahrbringender Menge in das Gehäuse eindringen.
IP X7	Schutz gegen das Eintauchen (t)	Eindringen von Wasser in gefahrbringender Menge dürfen beim Eintauchen in Wasser unter vorgegebenen Bedingungen hinsichtlich Druck und Zeit nicht stattfinden.
IP X8	Schutz gegen Untertauchen (t ...m)	Das Gerät ist unter Bedingungen, die vom Hersteller genannt werden, für Dauerbetrieb unter Wasser geeignet. Anmerkung: Üblicherweise bedeutet dies, dass das Gerät vollständig abgedichtet ist. Jedoch kann dies bei bestimmten Geräten auch bedeuten, dass Wasser zwar eindringt, jedoch keine Schädigung verursacht.

SCHUTZKLASSEN	
	<b>Schutzklasse I:</b> Geräte und Leuchten mit Anschlussstelle für Schutzleiter, mit der alle berührbaren Metallteile verbunden sein müssen, die im Fehlerfall unmittelbar Spannung annehmen können. Anschluss an Netzschutzleiter zwingend erforderlich. Das Symbol ist an der Anschlussstelle angebracht.
	<b>Schutzklasse II:</b> Bei solchen Geräten dürfen keine Metallteile berührbar sein, die im Fehlerfall unmittelbar Spannung annehmen können (Schutzisolierung oder doppelte Isolierung). Leuchte darf keinen Schutzleiteranschluss haben und nicht mit Netz- Schutzleiter verbunden werden.
	<b>Schutzklasse III:</b> Leuchten zum Betreiben mit Schutzkleinspannung (SELV), d.h. mit Spannungen unter 50V, die ein Sicherheitstransformator nach DIN VDE 0551 (EN60742) erzeugt oder die aus Batterien bzw. Akkumulatoren entnommen werden. Das Gerät darf keinen Schutzleiteranschluss haben und nicht mit Netz- Schutzleitern verbunden werden.

LEUCHTEN- UND BRANDSCHUTZ	
	<b>F-Zeichen</b> Leuchten mit dieser Kennzeichnung sind zur unmittelbaren Montage auf Gebäudeteilen aus nicht brennbarem, schwer- und normal entflammaren Baustoffen nach DIN 4102 geeignet. Leuchten mit F-Zeichen müssen so gebaut sein, dass an der Befestigungsfläche die Temperatur im anormalen Betrieb 130°C und im Fehlerfall des Vorschaltgeräts 180°C nicht überschritten werden.
	<b>M-Zeichen</b> Leuchten mit M-Kennzeichnung sind für den Einbau in Möbel bestimmt. Sie sind so gebaut, dass im Fehlerfall des Vorschaltgeräts schwer- und normalentflammare Werkstoffe im Sinn von DIN 4102, z.B. Ecken in Möbeln nicht entzündet werden können.
	<b>MM-Zeichen</b> Leuchten mit MM-Kennzeichen sind zum Ein- oder Anbau an Möbel bestimmt, die aus Werkstoffen bestehen, deren Entflammereigenschaften nicht bekannt sind. Sie sind so gebaut, dass im normalen Betrieb keine Befestigungsfläche und andere benachbarte Flächen der Möbel eine Temperatur von 95°C überschreiten. Bei 1,1-facher Nennspannung und im Fehlerfall des Vorschaltgeräts darf die maximale Temperatur an der Befestigungsfläche 115°C betragen.

## 1.1 Parallel - Schaltung

### 1.1.1 Niedervolt Reflektor- Lampen 12V

Diese sind seit vielen Jahren weit verbreitet. Hier werden alle Lampen an die 12V Ausgangsspannung des Trafos angeschlossen.  
Es können konventionelle Trafos mit 12V/50Hz Ausgangsspannung verwendet werden, oder elektronische Trafos mit 12V/20 kHz Ausgang (Hochfrequenz).

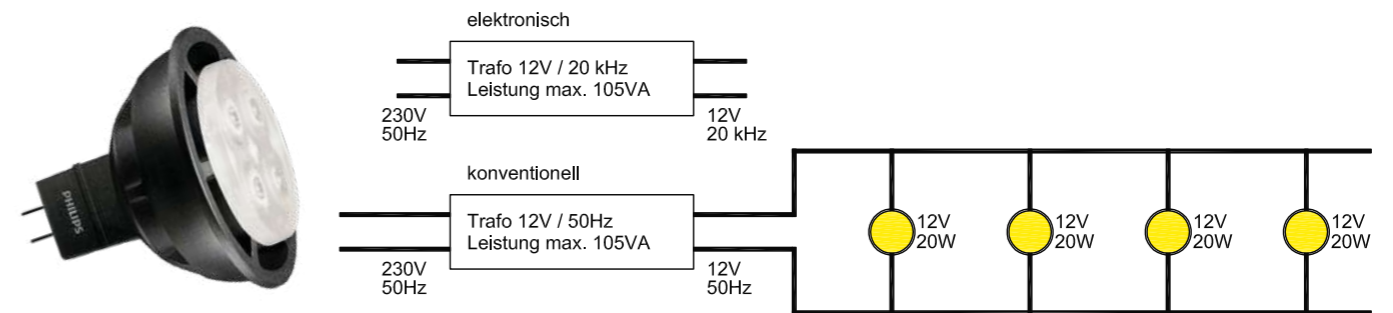

**Dimmen:** Phasenanschnitt-Dimmer für konventionelle Trafos  
Phasenabschnitt-Dimmer für elektronische Trafos

## 2. Strom

Alle Verbraucher, die den **gleichen Strom** benötigen, werden **in Serie (in Reihe)** an die Stromquelle angeschlossen. Somit fließt der gleiche Strom durch alle Verbraucher hindurch (Vergleichbar mit einer Perlenkette). Die Höhe der Spannung die am einzelnen Verbraucher abfällt, wird durch den Verbraucher selbst bestimmt.

**Gleichstrom**, mit definierter Richtung, dieser ist zeitlich in seiner Höhe unveränderlich, also ein konstanter Strom, daher spricht man auch von Konstantstromquellen. Diesen Strom finden wir z.B. bei LED Betriebsgeräten (z.B. 350mA) für LEDs.

**Wechselstrom**, mit wechselnder Polarität hat für LEDs keine Bedeutung und wird daher hier nicht weiter behandelt.

**Konverter** sind elektronische Geräte welche meist 230V/50Hz Wechselspannung aufnehmen und als Konstantstromquelle dann z.B. 350mA Gleichstrom zur Verfügung stellen. Die Polarität ist zu beachten. Wird die Polarität nicht beachtet, können Konverter und LED zerstört werden.

## 2.1 Serien- / Reihen- Schaltung

### 2.1.1 einzelne LEDs

Alle LEDs müssen vom gleichen Strom durchflossen werden (z.B. 350mA), und sind daher in Serie anzuschließen.  
Die Polarität (Plus- Kabel **ROT** und Minus- Kabel **SCHWARZ**) ist unbedingt zu beachten!  
Bei falschem Anschluss werden die LEDs zerstört!!!  
Der Konverter regelt selbstständig den Strom auf z.B. 350mA, solange die angegeben Anzahl an Strahler korrekt ist.

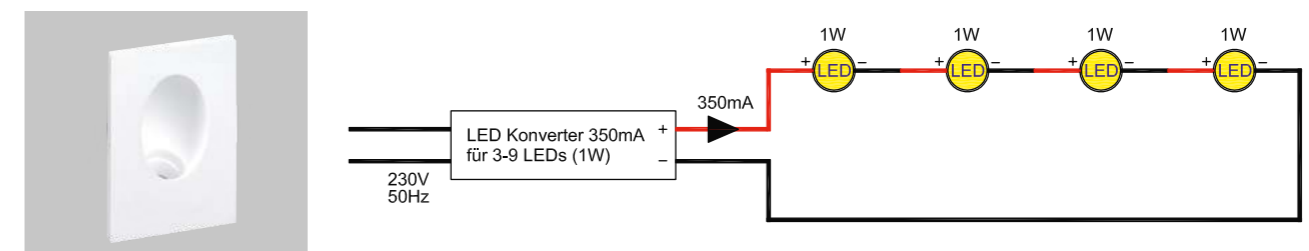

**Dimmen:** nur mit speziellen, dimmbaren Konvertern möglich. Ein herkömmlicher Dimmer darf nicht verwendet werden – Zerstörung der LEDs + Konverter.

### 2.1.3 Multi Chip LED

Moderne Power-LED-Strahler verwenden Multi-Chip-LEDs. Auf dem Multi Chip befinden sich mehrere einzelne LEDs. Da auch hier alle LEDs vom gleichen Strom durchflossen werden müssen, ist ebenfalls ein geeigneter Konverter notwendig. Polarität beachten!  
Ein Beispiel für einen Multi-Chip-LED-Strahler ist unser AGON Strahler, dieser benötigt einen 140mA-Konverter.

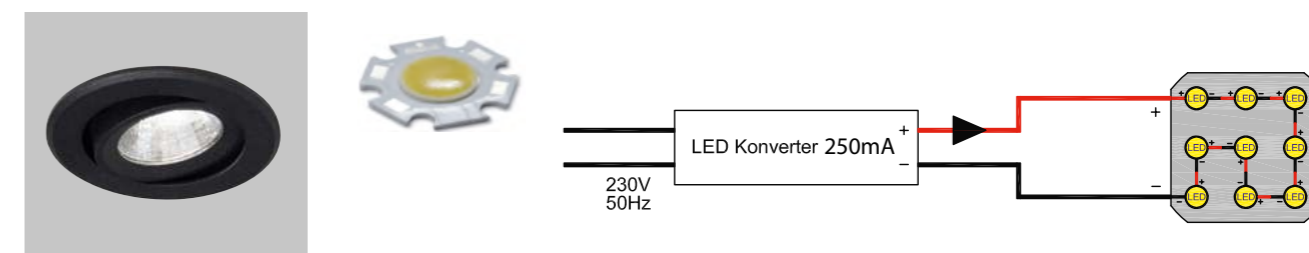

**Dimmen:** nur mit speziellen, dimmbaren Konvertern möglich. Ein herkömmlicher Dimmer darf nicht verwendet werden – Zerstörung der LEDs + Konverter.



## DIMMEN VON LED & LEUCHTSTOFFLAMPEN

### DIMMEN DALI - TASTER

nur DALI EVGs mit integrierter Touch DIM Funktion  
für max. 2 EVGs möglich, 1-Phasen Betrieb möglich

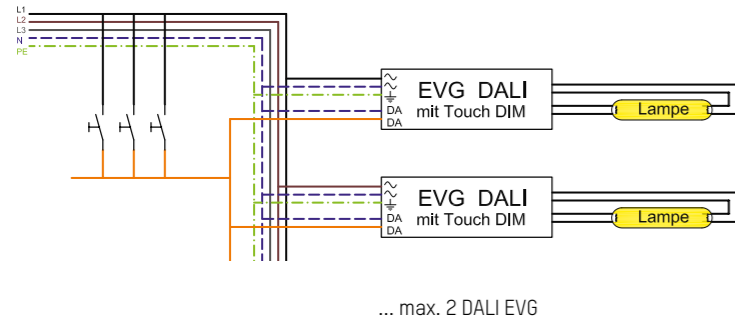

Schalten und dimmen mit allen handelsüblichen Tastern

### DIMMEN DALI - DALI MCU

alle DALI EVGs

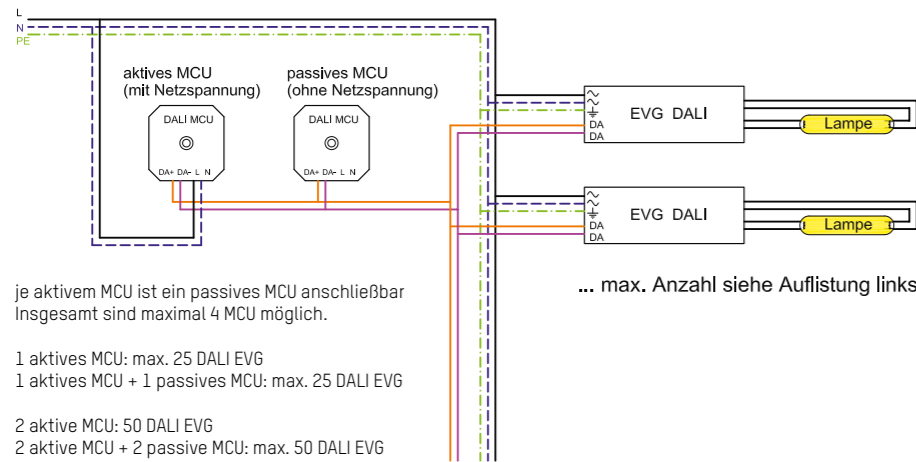

Schalten und dimmen mit dem DALI Drehrad MCU

je aktivem MCU ist ein passives MCU anschließbar  
Insgesamt sind maximal 4 MCU möglich.

- 1 aktives MCU: max. 25 DALI EVG
- 1 aktives MCU + 1 passives MCU: max. 25 DALI EVG
- 2 aktive MCU: 50 DALI EVG
- 2 aktive MCU + 2 passive MCU: max. 50 DALI EVG
- 3 aktive MCU: 75 DALI EVG
- 3 aktive MCU + 1 passives MCU: max. 75 DALI EVG
- 4 aktive MCU: max. 100 DALI EVG

### DIMMEN DALI - DALI REPEATER SO

alle DALI EVGs, für max. 64 EVGs

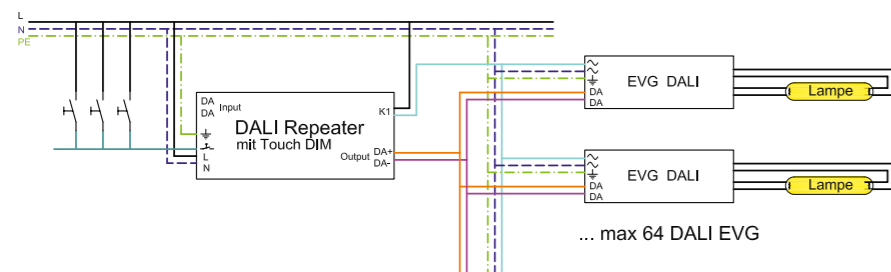

## LED - HINWEISE ZUR VERKABELUNG

Der Anschluss von elektrischen Verbrauchern an das elektrische Stromnetz unterliegt bestimmten Kriterien, diese sind Spannung, Strom, Polarität und Frequenz, und wir unterscheiden wie folgt:

### 1. Spannung

Alle Verbraucher, die die gleiche Spannung benötigen, werden parallel an die Spannungsquelle angeschlossen. Die Höhe des Stroms, der durch die einzelnen Verbraucher fließt, wird durch den Verbraucher bestimmt.

**Transformatoren** konventioneller Bauart sind Geräte welche Wechselspannung in der Höhe verändern können, z.B. von 230V/50Hz auf 12V/50Hz.

**Transformatoren** elektronischer Bauart sind Geräte welche Wechselspannung in der Höhe verändern können, dabei aber auch die Frequenz verändern, z.B. von 230V/50Hz auf 12V/20kHz. 12V Glühlampen kommen damit zurecht, andere Verbraucher aber nicht, auch keine 12V LEDs. [Ausnahme LED Retrofit]

## LED-KONVERTER RGB 1-10V & PUSH & IR

### DIMMEN WEISSER LED STRIPES 24 V DIMMEN PER TASTER

kurzer Tastendruck zum Ein-/Ausschalten, langer Tastendruck zum Auf-/Abdimmen, mit Auto-Stop bei minimalen und maximalen Werten mit dimmbarem Betriebsgerät VSTR 120 (230 V-50 Hz auf 0-24 V DC) 24 V Konverter (100 W) für maximal 1 x 6,9 m weißes LED Strip 24 V (je 14.4 W/lfm)

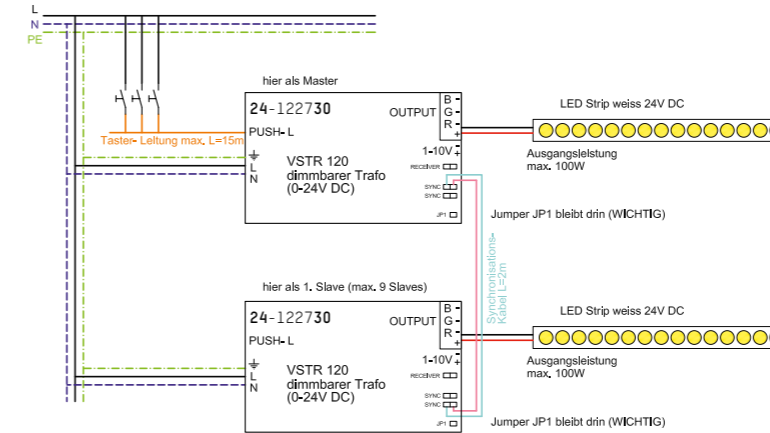

### DIMMEN WEISSER LED STRIPES 24 V DIMMEN 1-10 V

Dimmen mit Potentiometer am 1-10 V Eingang mit dimmbarem Betriebsgerät VSTR 120 (230 V-50 Hz auf 0-24 V DC) 24 V Konverter (100 W) für maximal 1 x 6,9 m weißes LED Strip 24 V (je 14.4 W/lfm)

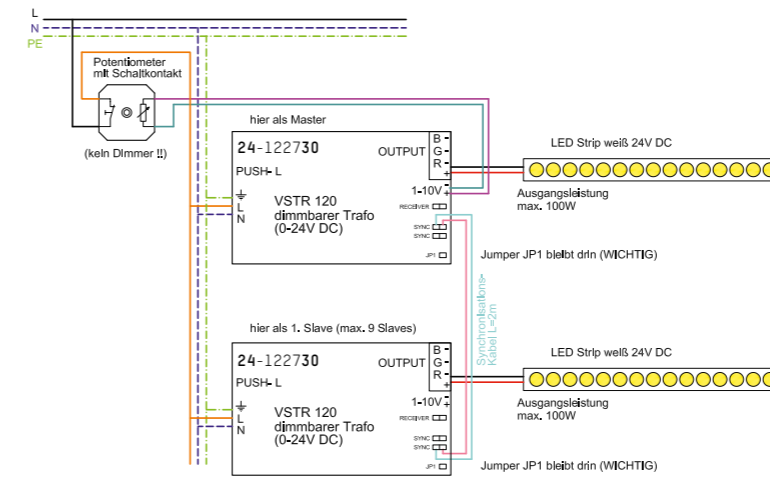

### DIMMEN RGB LED STRIPES 24 V DIMMEN PER FERNBEDIENUNG

Infrarotfernbedienung: es können alle drei Farbkanäle einzeln oder gemeinsam gedimmt werden + einfacher Farbdurchlauf mit dimmbarem Betriebsgerät VSTR 120 (230 V-50 Hz auf 0-24 V DC) 24 V Konverter (120 W) für maximal 1 x 8,5 m weißes LED Strip 24 V (je 14.4 W/lfm)

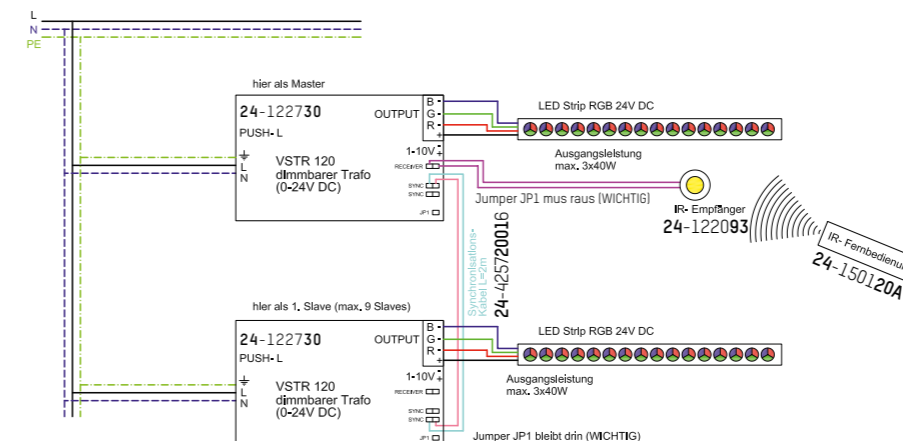

## MAXI JOLLY

### DIMMEN POWER LEDS DIMMEN PER TASTER

Kurzer Tastendruck zum EIN/AUS- Schalten, langer Tastendruck zum AUF/AB- Dimmen, mit Auto-Stop bei min. und max. Werten, die Stellung der DIP-Schalter (DIP switch) legt den Konstantstrom des Konverters am Ausgang fest.

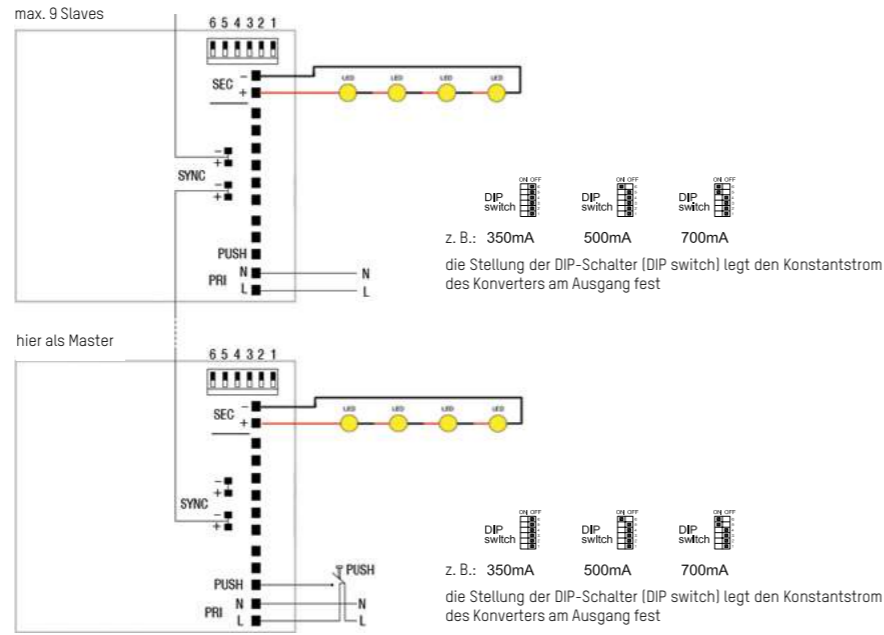

### DIMMEN POWER LEDS DIMMEN 1-10V

Dimmen mit Potentiometer am 1-10V Eingang mit dimmbarem Betriebsgerät MAXI JOLLY, die Stellung der DIP-Schalter (DIP switch) legt den Konstantstrom des Konverters am Ausgang fest.

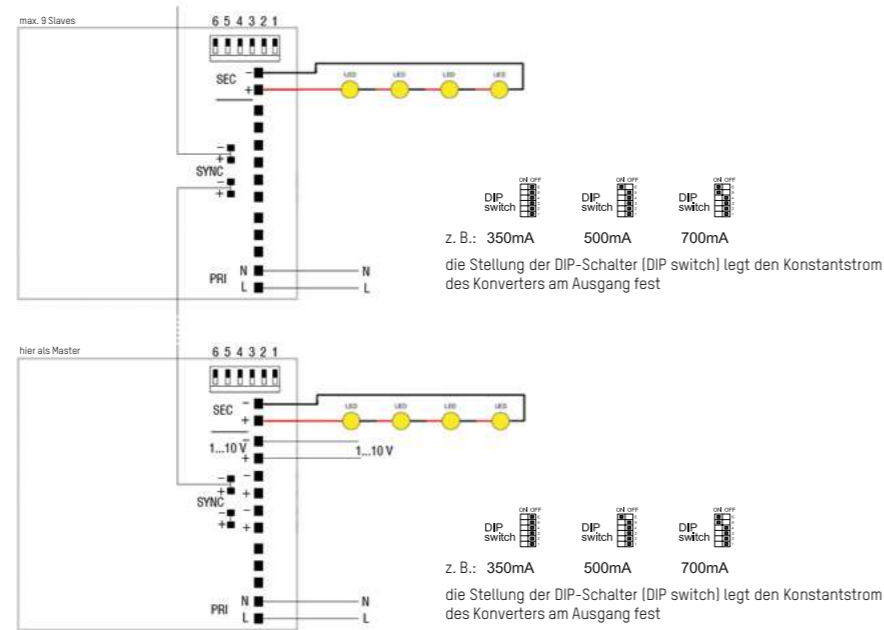

### DIMMEN POWER LEDS DIMMEN DALI

Dimmen über DALI Steuerung, die Stellung der DIP-Schalter (DIP switch) legt den Konstantstrom des Konverters am Ausgang fest.

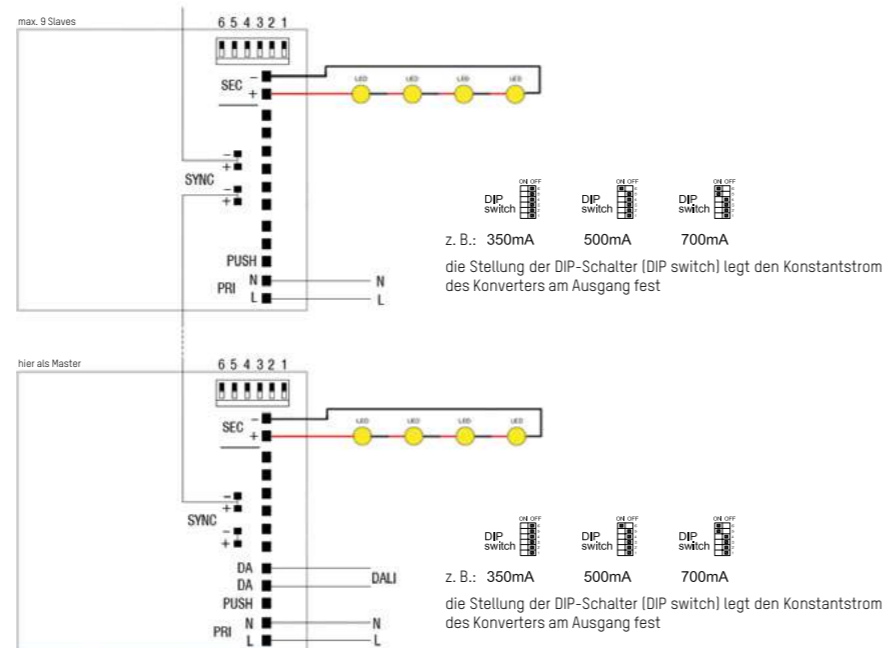

## DALieco ALS MANUELLE TASTENSTEUERUNG

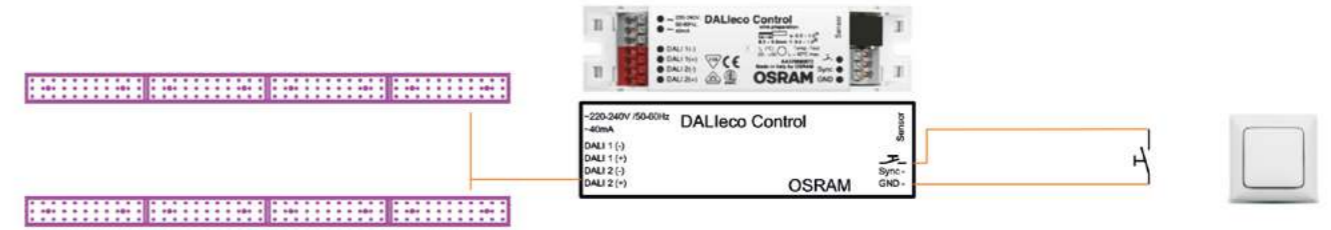

Manuelle Dimmen und Schalten von bis zu 32 EVG's  
Länge des Anschlusskabels zu den Tasten von bis zu 50m, beliebig viele Teilnehmer

## DALieco ALS MANUELLE 2-KANAL-TASTENSTEUERUNG (kein Sensor angeschlossen)

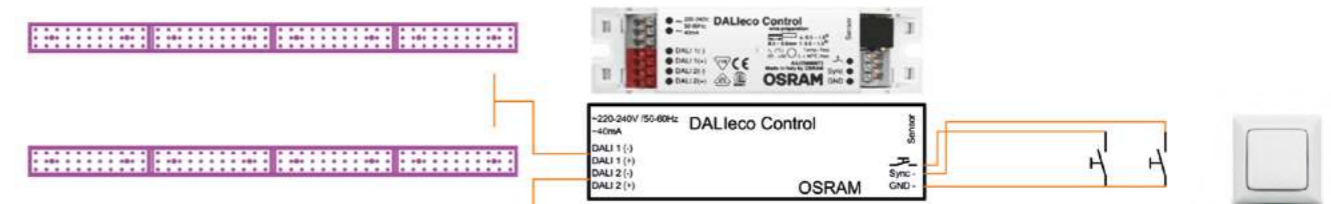

Manuelle Dimmen und Schalten von bis zu 2 x 16 EVGs  
Aktivierung des Tastersteuerungseingangs für Kanal 2 durch gleichzeitiges Drücken beider Taster für 10 Sek.  
Länge des Anschlusskabels zu den Tastern von bis zu 50m, beliebig viele Taster anschließbar

## DALieco FÜR DIE AUTOMATISCHE LICHTSTEUERUNG VON EINZELLEUCHTEN/EINZELBÜROS

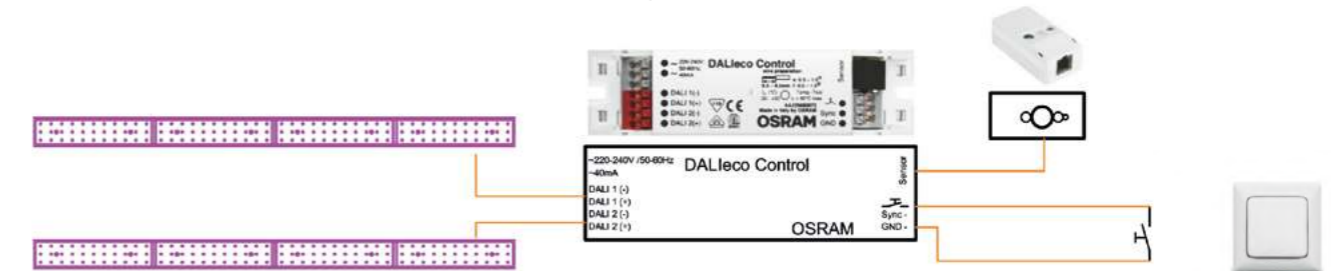

Länge des Anschlusskabels zu den Tastern von bis zu 50m, beliebig viele Taster anschließbar

## UNIVERSALDIMMER

Dimmer zur Ansteuerung über DALI, 1 - 10V oder PUSH Dimm. für weiße 24V LED Stripes

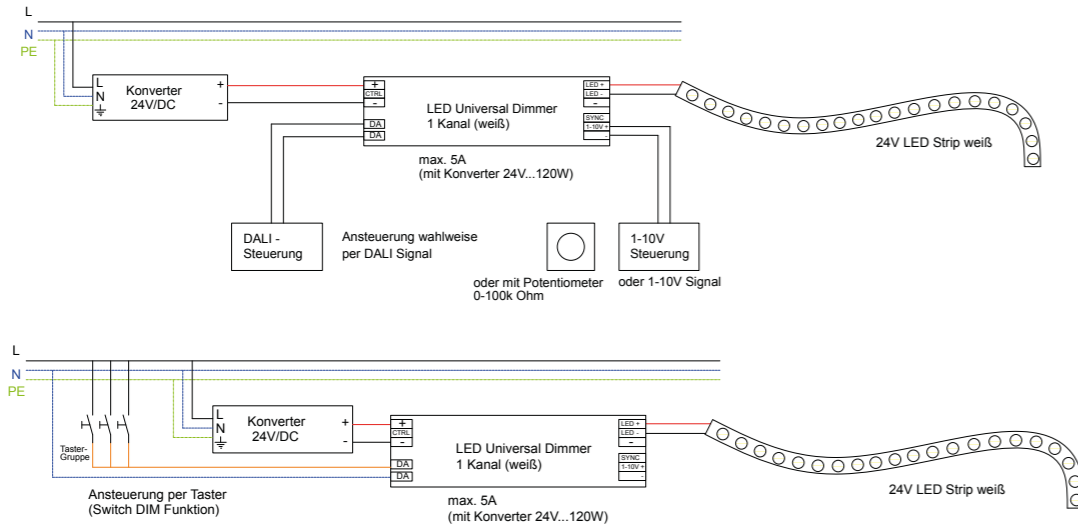

## DMX RGBW DIMMER

für die DMX Ansteuerung von max. 14m RGBW LED Stripes 24V bei 17,3W/lm (Entspricht 250W Gesamtleistung)

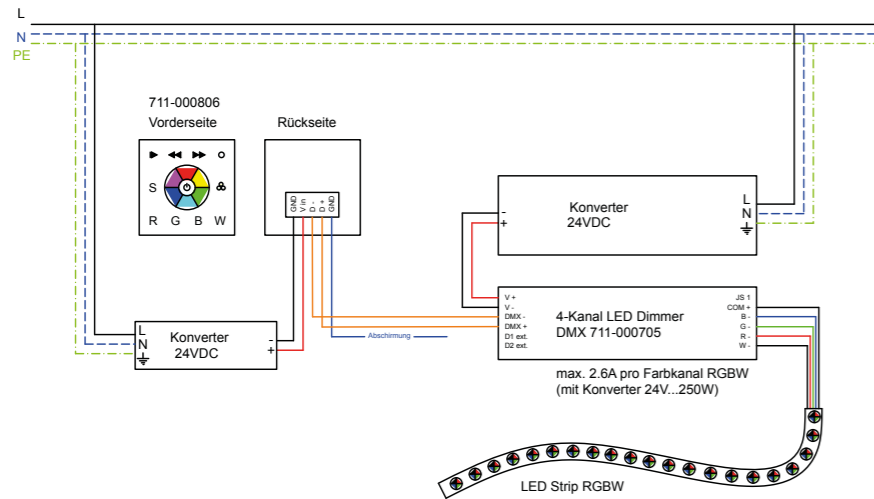

## RGBW FUNKDIMMER

Zur Ansteuerung von 24V LED Stripes RGB, RGBW oder weißen 24V LED Stripes. Kommunikation zwischen Controller und Bedienstellen erfolgt über Funk.  
Optionale APP Steuerung möglich (siehe unten)

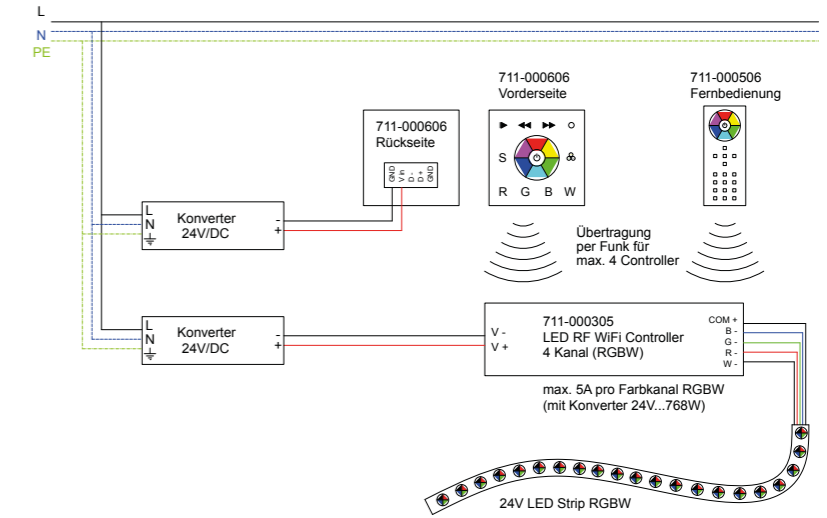

## RGBW FUNKDIMMER

APP Steuerung des RGBW Funkdimmers zur Integration in ein häuseigenes WLAN, APP steht zum kostenlosen Download in diversen APP Stores zur Verfügung

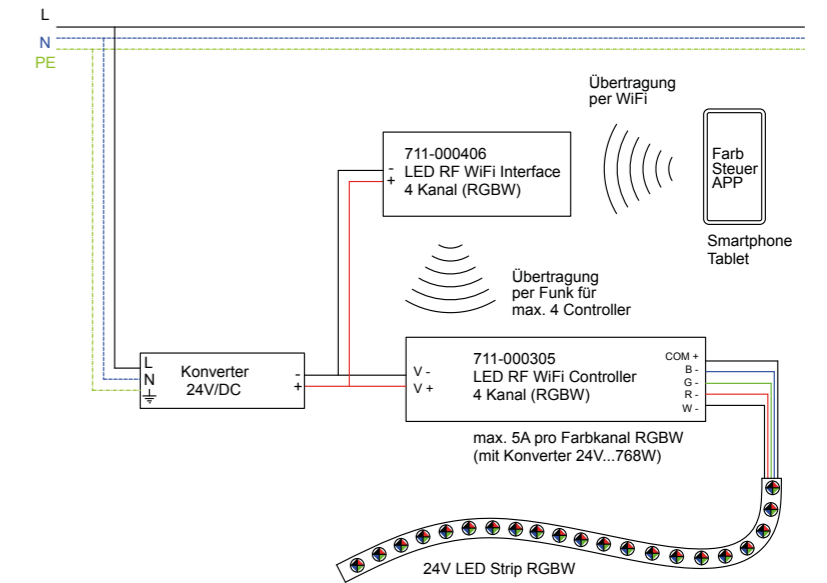

## FUNK DIMMER TUNABLE WHITE

2-Kanal Funk Dimmer für die Ansteuerung von Tunable White LED Stripes max. 5A/Kanal, 110-240W/24V

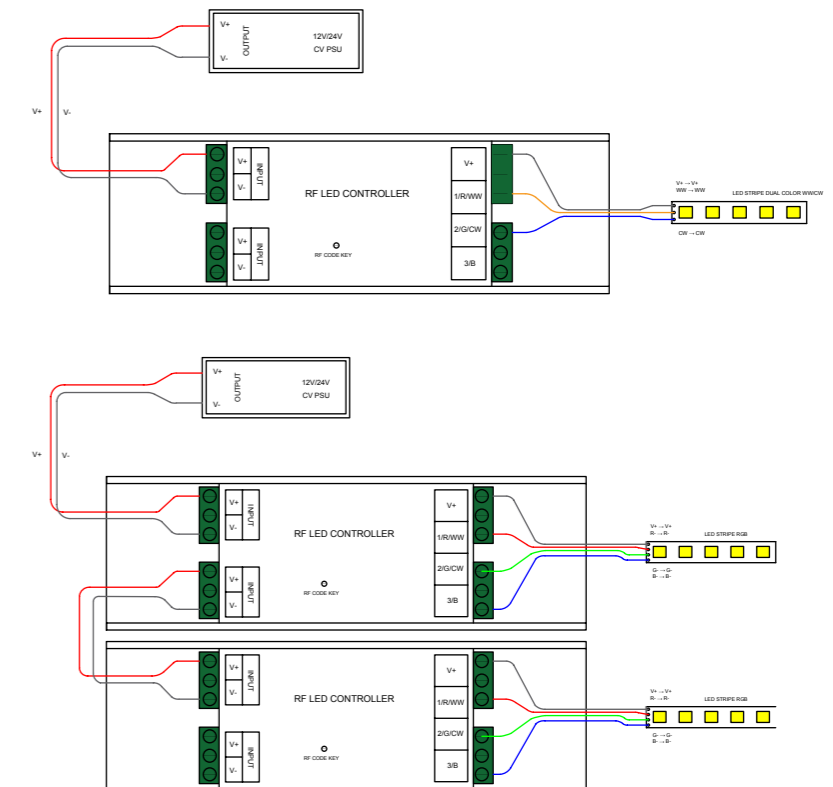

## DALI DT8 / PUSH LED KONVERTER

LED Konverter für LED Stripes, dimmbar DALI DT8 Push Dimm. 2 Kanal - max. 75W.

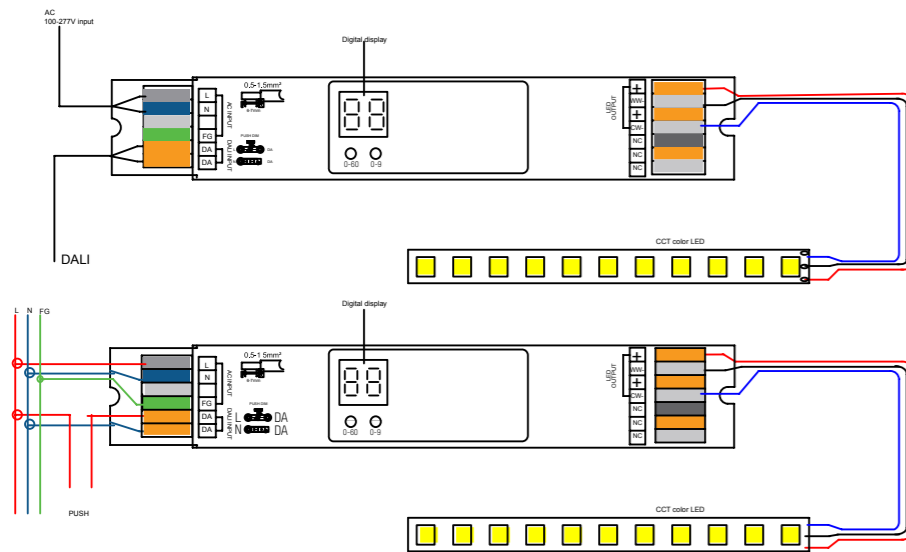

## DALI / PUSH LED KONVERTER

LED Konverter für LED Stripes, dimmbar DALI Push Dimm. 2 Kanal - max. 30W.

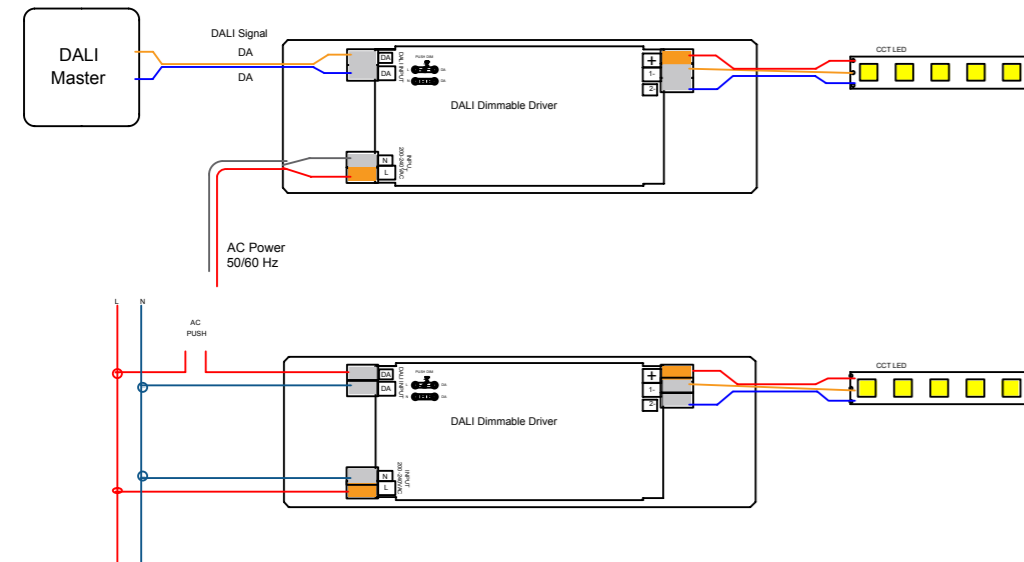

## DALI / PUSH LED KONVERTER

LED Konverter für LED Stripes, dimmbar DALI Push Dimm. 1 Kanal - max. 150W.

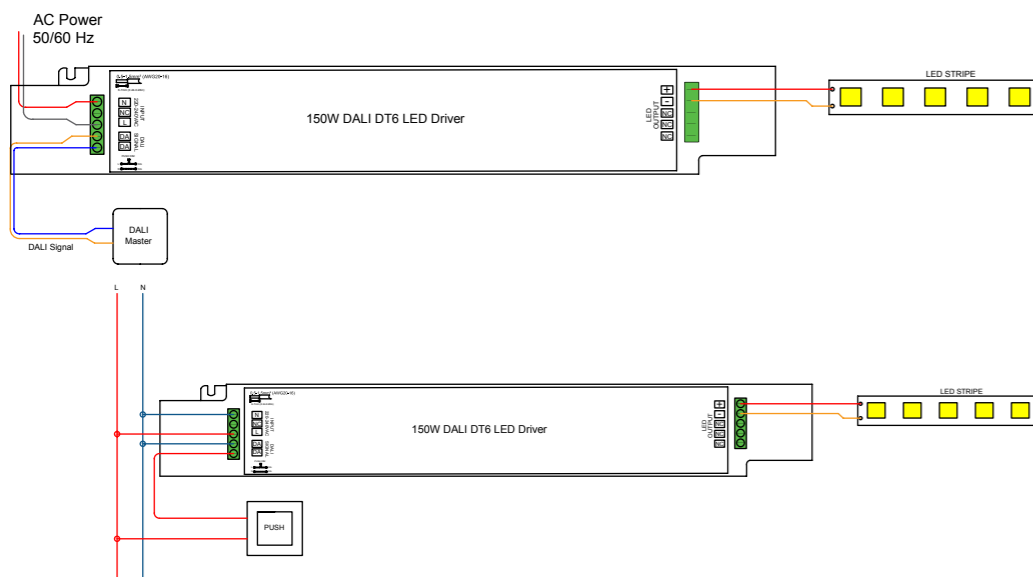

## LED KONVERTER QT DALI

28-177900 - 50W - DALI LED Konverter für LED Stripes, dimmbar DALI Push Dimm. 1 Kanal - max. 50W.  
 28-177924 - 80W - DALI LED Konverter für LED Stripes, dimmbar DALI Push Dimm. 1 Kanal - max. 80W.  
 28-177948 - 160W - DALI LED Konverter für LED Stripes, dimmbar DALI Push Dimm. 1 Kanal - max. 160W.

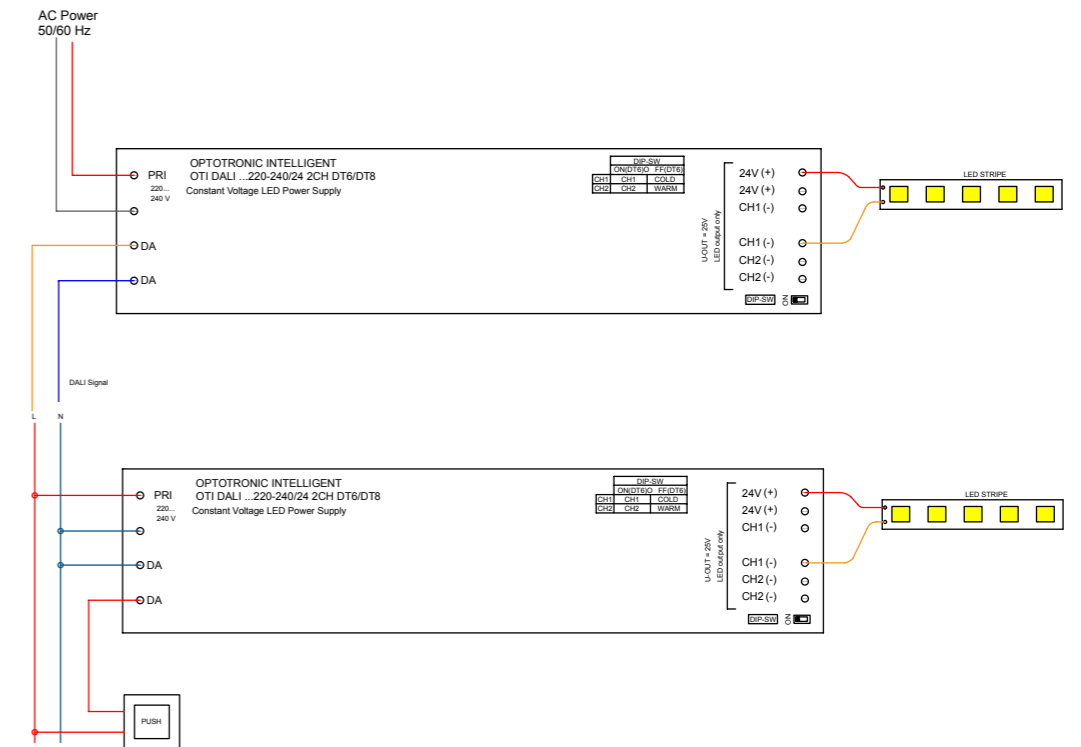

## DALI DT8 / PUSH LED DIMMER - 4 KANAL

Dimmer für LED Stripes, DALI DT8 RGB/W, tunable white, 60-180W/24V

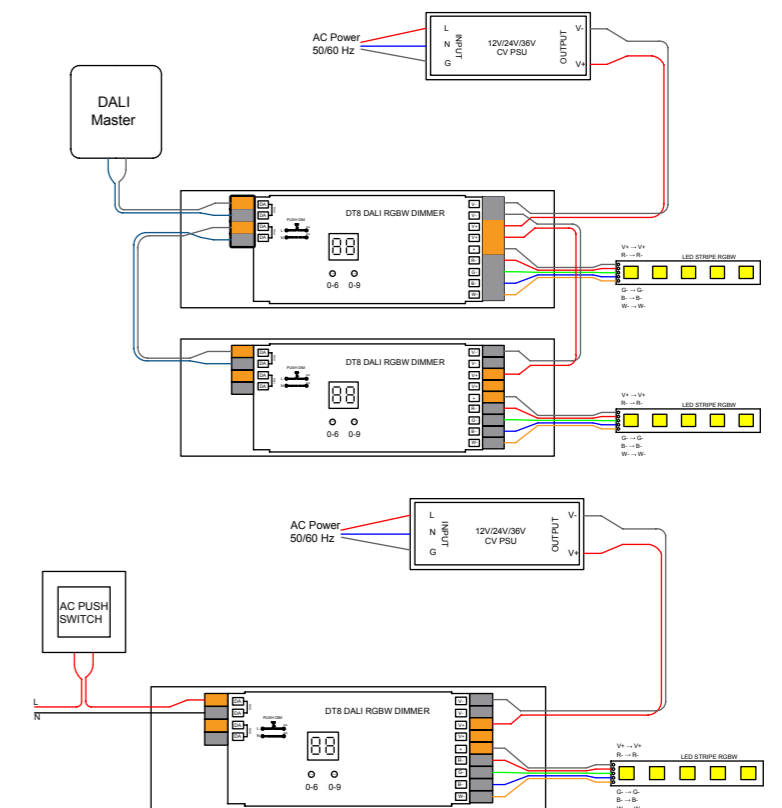

## DALI DT8 / RGBW-TOUCHPANEL

Lichtszenenkontroller DALI DT8 RGB/W, 4 Szenen konfigurierbar, Montage in Standard-Einbaudose Ø 68mm.

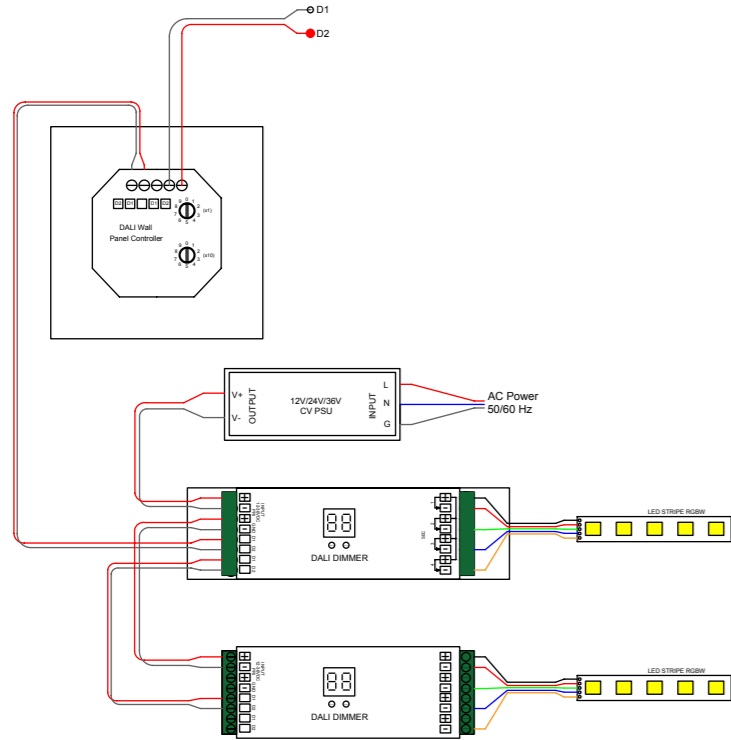

## DALI DT8 TUNABLE WHITE - TOUCHPANEL

Lichtszenenkontroller DALI DT8 tunable white, 4 Szenen konfigurierbar, Montage in Standard-Einbaudose Ø 68mm.

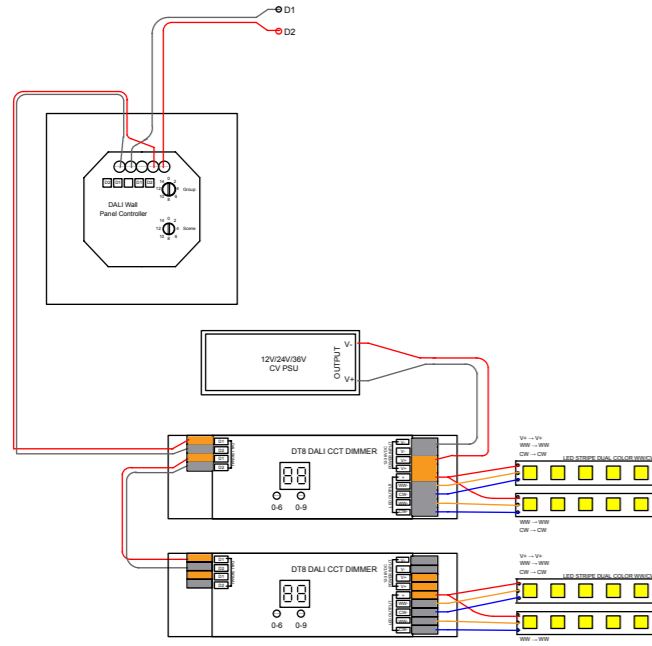

## PUSH BUTTON INTERFACE

Zur Integration von handelsüblichen Tastern in die MOLTO LUCE Smart App. 3 Kanal UP-Dosenmodul

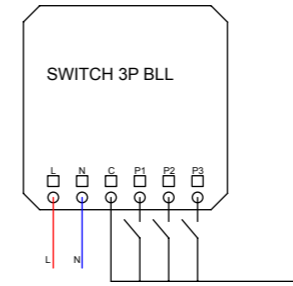

## INTERFACE SMART BLUETOOTH TO DALI

Zur Integration von max. 40 Dali dimmbaren Leuchten in die MOLTO LUCE Smart App.

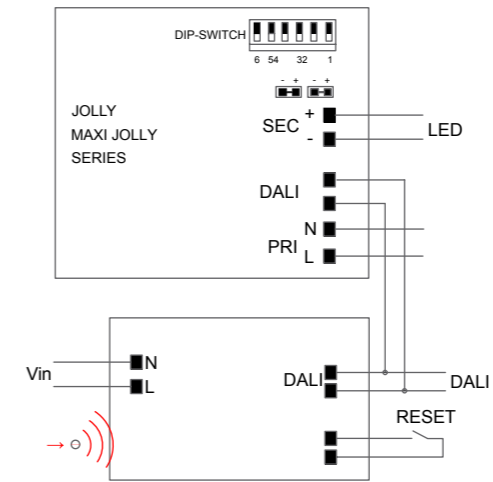

## BLUETOOTH DIMMER-2 KANAL

BLUETOOTH DIMMER-2 KANAL

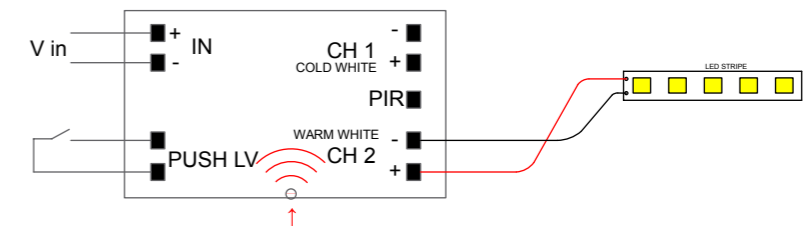

## BINNING

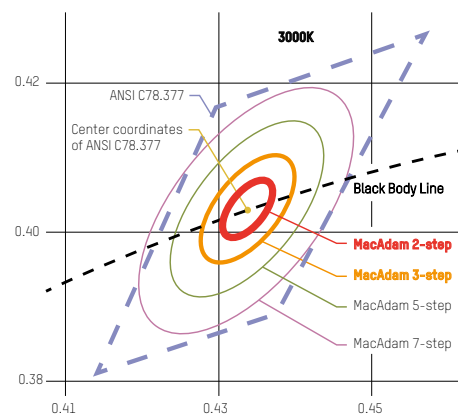

Produktionsbedingt gibt es bei der Herstellung von LEDs immer kleine Unterschiede in Lichtfarbe, Farbwiedergabe und Helligkeit der einzelnen LEDs. Diese Unterschiede würden im Vergleich mehrerer gleicher Produkte auffallen. Um dies zu vermeiden gibt es das sogenannte Binning. Bei dieser Sortierung werden alle LEDs einzeln getestet und in Gruppen, sogenannte Bins sortiert. Ein Bin enthält nur LEDs mit gleichen Werten. Dieser Binning-Prozess wird anhand der MacAdam Ellipse durchgeführt. Diese Ellipse definiert jenen Bereich, in dem keine Unterschiede für den Menschen wahrnehmbar sind. Entsprechend dem Stand der Technik werden bei Molto Luce Produkten ausschließlich LEDs führender Hersteller mit MacAdam (SDCM) 3Step Binning verbaut.

## COB - CHIP ON BOARD

Bei COB Modulen werden die LED-Chips direkt auf wärmeleitendes Material (Board) geklebt und mittels dünnen Golddrähten elektrisch miteinander verbunden. Um den mechanischen Schutz der Bauteile zu gewährleisten und weißes Licht erzeugen zu können, wird diese Anordnung danach mit einem Silikon-Phosphor-Gemisch stabilisiert. Ein wesentlicher Vorteil dieser Technologie liegt im geringeren Wärmeübergang der LED-Chips auf den Kühlkörper (thermischer Widerstand).

Ein optimiertes Wärmemanagement verbessert in der Folge unmittelbar Lebensdauer und Farbdrift der Chips.

Mehrere LED-Chips können so auf einer kleinen Fläche untergebracht und kollektiv enorme Lichtströme erzeugt werden.



## STANDARDLEBENSDAUER

L80/B10 50.000h Ta max=25°C

80% Restlichtstrom nach 50.000 Stunden Betrieb, unterschritten von max. 10% der Leuchten der Testreihe.

Bestimmungsgemäßer Betrieb der Leuchte bei max. 25°C Umgebungstemperatur (außer gesondert angegeben).

## LICHTSTROM

Der gerechnete Lichtstrom der Leuchte wird unter Berücksichtigung aller Verminderungsfaktoren wie Temperatur, Reflektorwirkungsgrad, Schutzglas-Transmissionswert und konstruktiven Faktoren, gemäß der technischen Datenblätter und Herstellerangaben, ausgewiesen. Die im Katalog angeführten, berechneten Werte beziehen sich, wenn nicht anders angegeben, auf eine Referenzberechnung mit folgender Spezifikation: 3000K CRI 80 bei Ta=25°C

## LEISTUNGSANGABEN

Im Katalog wird ausschließlich die Systemleistung (SYS) angegeben, d.h. die aufgenommene Gesamtleistung von Leuchtmittel plus der Leistung des (LED) Betriebsgerätes. Ausnahmen sind nur Leuchten die ohne Betriebsgerät geliefert werden, hier wird die LED Leistung (LED) angegeben.

Die zum Zeitpunkt der Drucklegung des Katalogs verfügbaren Daten sind teilweise berechnete Werte. Die Leuchten werden nach dem Stand der Technik laufend optimiert. Elektrische Leistungsangaben sowie Lumenwerte unterliegen einer Toleranz von +/- 10%. Durch ein zertifiziertes Institut gemessene Werte sind nach aktuellem Stand in den Produktinformationen auf [www.moltoluce.com](http://www.moltoluce.com) und in der Lichtplanungssoftware DIALux zu finden.

Sämtliche Inhalte in diesem Katalog entsprechen dem Stand bei Drucklegung und dienen ausschließlich zu Informationszwecken. Molto Luce behält sich das Recht vor, jederzeit und ohne Ankündigung die technischen Daten der im Katalog abgebildeten Produkte zu modifizieren. Für Farbabweichungen übernehmen wir keinerlei Haftung. Manche der im Prospekt abgebildeten Produkte sind Bildretuschen und dienen zur Veranschaulichung der Einsatzmöglichkeiten. Unsere allgemeinen Geschäfts- und Lieferbedingungen können unter [www.moltoluce.com](http://www.moltoluce.com) eingesehen werden.